

# PILOT'S OPERATING HANDBOOK

SENECA II



FAA APPROVED IN NORMAL CATEGORY BASED ON FAR 23 AND FAR PART 21, SUBPART J. THIS HANDBOOK INCLUDES THE MATERIAL REQUIRED TO BE FURNISHED TO THE PILOT BY FAR 23 AND FAR PART 21, SUBPART J AND CONSTITUTES THE APPROVED AIRPLANE FLIGHT MANUAL AND MUST BE CARRIED IN THE AIRPLANE AT ALL TIMES.

AIRPLANE SERIAL NO. 34-8070084

AIRPLANE REGISTRATION NO. N35727

PA-34-200T  
REPORT: VB-850

FAA APPROVED BY: Ward Evans

WARD EVANS  
D.O.A. NO. SO-1  
PIPER AIRCRAFT CORPORATION  
VERO BEACH, FLORIDA

DATE OF APPROVAL: AUGUST 23, 1976

HANDBOOK PART NO. 761 634



**WARNING**

EXTREME CARE MUST BE EXERCISED TO LIMIT THE USE OF THIS MANUAL TO APPLICABLE AIRCRAFT. THIS MANUAL REVISED AS INDICATED BELOW OR SUBSEQUENTLY REVISED IS VALID FOR USE WITH THE AIRPLANE IDENTIFIED ON THE FACE OF THE TITLE PAGE WHEN OFFICIALLY APPROVED. SUBSEQUENT REVISIONS SUPPLIED BY PIPER AIRCRAFT CORPORATION MUST BE PROPERLY INSERTED.

MODEL PA-34-200T, SENECA II

PILOT'S OPERATING HANDBOOK, REPORT: VB-850 REVISION 10

PIPER AIRCRAFT CORPORATION  
APPROVAL SIGNATURE AND STAMP

*J. Wall* 

Published by  
PUBLICATIONS DEPARTMENT  
Piper Aircraft Corporation  
Issued: August 23, 1976

REPORT: VB-850

ii

## APPLICABILITY

The aircraft serial number eligibility bracket for application of this handbook is 34-7770001 through 34-8170092. The specific application of this handbook is limited to the Piper PA-34-200T model airplane designated by serial number and registration number on the face of the title page of this handbook.

This handbook cannot be used for operational purposes unless kept in a current status.

## REVISIONS

The information compiled in the Pilot's Operating Handbook will be kept current by revisions distributed to the airplane owners.

Revision material will consist of information necessary to update the text of the present handbook and/or to add information to cover added airplane equipment.

### I. Revisions

Revisions will be distributed whenever necessary as complete page replacements or additions and shall be inserted into the handbook in accordance with the instructions given below:

1. Revision pages will replace only pages with the same page number.
2. Insert all additional pages in proper numerical order within each section.
3. Page numbers followed by a small letter shall be inserted in direct sequence with the same common numbered page.

### II. Identification of Revised Material

Revised text and illustrations shall be indicated by a black vertical line along the outside margin of the page, opposite revised, added or deleted material. A line along the outside margin of the page opposite the page number will indicate that an entire page was added.

Black lines will indicate only current revisions with changes and additions to or deletions of existing text and illustrations. Changes in capitalization, spelling, punctuation or the physical location of material on a page will not be identified by symbols.

## ORIGINAL PAGES ISSUED

The original pages issued for this handbook prior to revision are given below:

Title ii through v, 1-1 through 1-14, 2-1 through 2-10, 3-1 through 3-18, 4-1 through 4-26, 5-1 through 5-34, 6-1 through 6-58, 7-1 through 7-36, 8-1 through 8-16, 9-1 through 9-18, 10-1 through 10-2.

## PILOT'S OPERATING HANDBOOK LOG OF REVISIONS

Current Revisions to the PA-34-200T Seneca II Pilot's Operating Handbook, REPORT: VB-850 issued August 23, 1976.

Revision Number and Code	Revised Pages	Description of Revision	FAA Approval Signature and Date
Rev. 1 - 761 634 (PR761029)	4-i	Revised para. 4.15; added para. 4.16 (Starting Engines - Optional Primer System); revised para. 4.19.	<i>Ward Evans</i> Ward Evans Oct. 29, 1976
	4-4	Revised Starting Engines; added Starting Engines with Optional Primer System; relocated Flooded Start to pg. 4-5.	
	4-5	Added Optional Primer System info; added Flooded Start from pg. 4-4; revised Cold Weather Start.	
	4-9	Added flap position Caution to para. 4.11.	
	4-11	Revised para. 4.15; added para. 4.16 (Starting Engines - Optional Primer System); relocated para. 4.17 to pg. 4-12.	
	4-12	Added Figure 4-3; added para. 4.17 from pg. 4-11; revised para. 4.19; relocated 4.19 info. to pg. 4-13.	
	4-13	Added revised para. 4.19 info from pg. 4-12.	
	4-22	Added flap position Note to para. 4.41.	
	6-i	Added para. 6.8 (Instructions for Using Weight and Balance Plotter).	
	6-4	Revised Fig. 6-3.	
	6-5	Revised item 6.3 (d) (2).	
	6-15, 6-16	Added para. 6.8 (Instructions for Using the Weight and Balance Plotter).	
	6-29	Added item 51 (Optional Engine Primer).	
	6-58	Revised item 321 Arm and Moment; added Scott No. 802180-01 to item 323.	
	7-13	Revised para. 7.15 info.	
7-16	Revised Fig. 7-15.		
9-5	Added Scott No. 802180-01 to Supplement 2 heading.		
10-1	Revised 10.3 (c).		
Rev. 2 - 761 634 (PR770311)	1-6	Corrected para. 1.19 (b).	(Signature and Date from previous entry)
	3-5	Added crossfeed info to Fuel Management During Single Engine Operation.	
	3-12	Added crossfeed info to para. 3.23.	
	4-6	Added manifold pressure line info to Before Takeoff - Ground Check.	
	4-11	Revised second Note in para. 4.16.	
	4-13	Revised starting procedure in para. 4.19; relocated Note to page 4-14.	
	4-14	Added relocated Note; added manifold pressure line info to ground check procedure in para. 4.25.	

**PILOT'S OPERATING HANDBOOK LOG OF REVISIONS (cont)**

Revision Number and Code	Revised Pages	Description of Revision	FAA Approval Signature and Date
Rev. 2 - 761 634 (PR770311) (cont)	5-32 6-4 6-21  6-37  6-39  6-56  7-8 7-13 7-23  7-25 7-28  7-30 8-12	Revised gross weight in example for Fig. 5-41. Revised A & B arms in Fig. 6-3. Added Weight, Arm and Moment to item 13a.; added item 13b.; changed existing item 13b. to 13c. Revised item 115 Dwg. 99002-5 to -8, item 117 Dwg. 99003-5 to -7 and item 119 Cert. Basis - STC C6c, C9c, C52c, to TSO C6c, C9c, C52c. Revised item 137 Dwg. 99002-5 to -8 and 99003-5 to -7. Added Dwg. 79592-2 to item 285 and Dwg. 79592-3 to item 287. Revised fuel injector info in para. 7.5. Revised info in para. 7.15. Added manifold pressure line drain valve info to para. 7.23. Added relocated material from page 7-28. Relocated material to page 7-25; added seat retainer info to Note in para. 7.27. Revised ELT test info in second Note in para. 7.35. Revised info in para. 8.23.	           <i>Ward Evans</i> Ward Evans March 11, 1977
Rev. 3 - 761 634 (PR770411)	2-1 2-7 4-1	Revised para. 2.3 Design Maneuvering Speeds. Revised para. 2.29 Maneuvering Speed Placard. Revised item 4.3 (c).	 <i>Ward Evans</i> Ward Evans April 11, 1977
Rev. 4 - 761 634 (PR770801)	1-11, 1-12, 1-13, 1-14 2-8 3-i 3-3 thru 3-7  3-9 thru 3-17  4-7 4-13 4-17 6-47 6-48  6-49 6-50 6-51	Revised 1.21, Conversion Factors. Revised Takeoff Check List. Revised Table of Contents. Added Engine Inoperative Procedures section and restructured Emergency Check List to accommodate addition. Added Engine Inoperative Procedures and restructured Amplified Emergency Procedures to accommodate addition. Revised Climb Procedure. Revised Starting Procedures. Revised para. 4.29, Climb. Revised item nos.; added item; relocated item. Revised item nos.; added relocated item; added new items; relocated items. Added new items; added relocated items. Added new items; added relocated items. Revised item nos.; added new items; relocated items; revised item 289.	

**PILOT'S OPERATING HANDBOOK LOG OF REVISIONS (cont)**

Revision Number and Code	Revised Pages	Description of Revision	FAA Approval Signature and Date
Rev. 4 - 761 634 (PR770801) (cont)	6-52	Added items.	
	6-55	Revised item nos.	
	6-56	Revised items nos.; revised item.	
	6-57	Revised item nos.; added new items; relocated items; revised item 395.	
	6-58	Revised item nos.; added relocated items; revised item.	
	7-i	Revised page no. of para. 7.35; added para. 7.41.	
	7-2	Revised Figure 7-5.	
	7-17	Added cabin courtesy light system to 7.17, Electrical System.	
	7-29	Added baggage compartment light to 7.31, Baggage Area; relocated 7.35, ELT.	
	7-30	Added material from page 7-29; relocated Note to page 7-31.	
	7-31	Added relocated material.	
	7-35, 7-36	Added para. 7.41, Radar.	
	9-7	Added STC No. to Section 1; revised (a) in Section 2; in Section 3 revised (c) and (d) and added (e); relocated Section 4 to page 9-8.	
	9-8	Added part of Section 3; added relocated Section 4; deleted "INSPECTION" from Section 4; revised PREFLIGHT item (a) (2); revised IN-FLIGHT item (b); relocated material to page 9-10.	
	9-9	Added relocated material; revised (c) (2); revised (d); revised (d) (2) a., (d) (2) b. and (d) (3) a.; relocated (e) (3) and Section 5 to page 9-10.	
	9-10	Added relocated material.	
	9-11	Added STC No. to Section 1; revised Section 2, items (a) and (c); relocated material to page 9-12.	
	9-12	Added relocated material; relocated (e) to page 9-13 as (f); added new (e).	
	9-13	Added continuation of new (e); deleted EMERGENCY OPERATION WITH OPTIONAL HSI which is now incorporated in (e); added relocated old (e) which becomes (f); relocated Section 4, item (b) to page 9-14.	
	9-14	Added relocated material; revised (b) (4); added TRIM SYSTEM heading; revised trim info. under "General"; (c) and (d) become (a) and (b); revised (a) (5); relocated material to page 9-15.	
9-15	Added relocated material; revised (c) (1); revised (e); relocated (f) (2) to page 9-16.		
9-16	Added relocated material; revised (f) (2) a. and c.; revised (h) (1) a.		
9-17	Revised (2) b. and d.		
10-2	Added item (m).		

*Ward Evans*

Ward Evans  
Aug. 1, 1977



**PILOT'S OPERATING HANDBOOK LOG OF REVISIONS (cont)**

Revision Number and Code	Revised Pages	Description of Revision	FAA Approval Signature and Date
Rev. 6 - 761 634 (PR780830)	1-3, 1-4	Revised Propellers information and moved items to a new page.	
	1-4a	Relocated items.	
	1-4b	Added page and added relocated item.	
	1-6	Changed Celcius to Celsius.	
	2-i	Revised index	
	2-2	Relocated items to a new page.	
	2-3	Revised propeller information, tachometer markings and relocated items to page 2-4.	
	2-4	Added items from 2-3 and relocated items to page 2-5.	
	2-5	Added items from 2-4 and relocated items to page 2-6.	
	2-6	Added items from 2-5 and added 2.31 Noise Level.	
	2-7	Added info. and changed 2.29 to 2.33.	
	2-9	Added two placards.	
	3-15	Added "and the green gear lights may not illuminate."	
	5-1	Added two and three bladed propeller information.	
	6-31	Added McCauley Propellers item 59 and Synchrophasers item 60.	
	6-41	Added items 165 and 167 on KFC 200 Flight Control Systems.	
	6-43	Revised items 171 and 173.	
	6-45, 6-46	Revised items 189, 191, 193, 194, 195, 196, 197, 199, 201 and 202.	
	6-51	Revised item 297 and relocated item 301 to 6-52	
	6-52	Added item 301.	
	6-55	Revised item 355.	
	6-56	Added item 358 and relocated item 375 to page 6-57.	
	6-57	Relocated item 375 from page 6-56 and relocated items 399 and 401 to page 6-58.	
	6-58	Relocated items 399 and 401 from page 6-57 and added item 400. Relocated note from 6-57. Relocated "Exterior Finish" to new page 6-59.	
6-59	Added new page 6-59 and relocated "Exterior Finish."		
7-i	Revised index.		
7-4, 7-5	Added McCauley propeller information under 7.7 PROPELLERS and added propeller synchrophaser information. Relocated part of bottom paragraph page 7-5.		
7-6	Relocated part of paragraph from page 7-5.		
7-22	Revised instrument panel title.		



**PILOT'S OPERATING HANDBOOK LOG OF REVISIONS (cont)**

Revision Number and Code	Revised Pages	Description of Revision	FAA Approval Signature and Date
Rev. 6 - 761 634 (PR780830) (cont.)	7-22a 7-22b 7-28, 7-29 7-30 7-33  7-36 8-9, 8-10 9-i 9-19, 9-20 9-21 thru 9-30 9-31 thru 9-40	Added new page with revised instrument panel. Added new page. Added optional cabin work table information. Revised ELT information. Added McCauley propeller deicing sequence information. Added 7.34 AIR CONDITIONING. Added McCauley propeller service information. Revised index. Added pages and added Air Conditioning Supplement. Added pages and Added KFC 200 AFCS Autopilot (with Flight Director) Supplement. Added pages and Added KFC 200 AFCS Autopilot (without Flight Director) Supplement.	<i>Ward Evans</i> Ward Evans August 30, 1978
Rev. 7 - 761 634 (PR781229)	1-12 1-13 2-8 6-37 6-43 6-44 6-45  7-9	Revised para. 1.21. Revised para. 1.21. Revised para. 2.33. Revised item 113. Added item 180. Added item 187 from pg. 6-45. Relocated item 187 to pg. 6-44; revised items 189 and 191. Revised Fig. 7-7.	<i>Ward Evans</i> Ward Evans Dec. 29, 1978
Rev. 8 - 761 634 (PR790413)	6-51  6-52 7-30 7-30a 7-30b 7-31	Revised item 293; added item 294; relocated item 299 to pg. 6-52. Added item 299 from pg. 6-51. Revised para. 7.35. Added pg. (added para. 7.35 info.). Added pg. Deleted Note.	<i>Ward Evans</i>  Ward Evans April 13, 1979
Rev. 9 - 761 634 (PR790709)	1-4 1-7 2-1, 2-2 2-4 2-7, 2-8, 2-9 2-10 3-9 4-9 4-18 5-3 thru 5-6 5-21	Revised para. 1.11 (c). Revised para. 1.19 (e). Revised para. 2.3. Revised para. 2.11 (d). Revised para. 2.33. Added placards to para. 2.33. Revised para. 3.7. Revised para. 4.7. Revised para. 4.31. Revised para. 5.5 (a),(c),(d),(e),(f) and (g). Revised Figure 5-21.	

**PILOT'S OPERATING HANDBOOK LOG OF REVISIONS (cont)**

Revision Number and Code	Revised Pages	Description of Revision	FAA Approval Signature and Date
Rev. 9 - 761 634 (PR790709)	5-22	Relocated Figure from pg. 5-23.	
	5-23	Revised and relocated Figure 5-23 to pg. 5-22; added Figure from 5-24.	
	5-24	Revised and relocated Figure 5-25 to pg. 5-23; added Figure 5-26.	
	5-25	Revised Figure 5.27.	
	5-26	Revised and relocated Figure 5-29 to pg. 5-26a ; added Figure 5-28.	
	5-26a	Added page; (added Figure from pg. 5-26.)	
	5-26b	Added page.	
	5-28	Revised Figure 5-33.	
	6-i	Revised index.	
	6-1	Revised para. 6.1.	
	6-10a	Added page; (added 6.6 General Loading Recommendations).	
	6-10b	Added page.	
	6-11, 6-12	Revised Figures 6-9 and 6-11.	
	6-37	Added item 124.	
	6-38	Added item 130.	
	6-42a	Added page; (added Bendix Radio items.)	
	6-42b	Added page.	
	6-43	Revised item nos. 171 to 176, 173 to 177, 175 to 179, 177 to 180, 179 to 181 and 180 to 182; added items 178 and 183.	
	6-44	Revised item nos. 181 to 184, 183 to 186, 185 to 187 and 187 to 188; added item 185.	
	6-45	Added item 192.	
	6-46	Added items 200, 204 and 210.	
	6-51	Revised item 295.	
	6-52	Revised item 299.	
	6-56	Revised item 369.	
	6-58	Relocated info. to pg. 6-59.	
	6-59	Added info from pg 6-58 and item 410.	
	6-60	Added page.	
	6-61, 6-62	Added pages; (added 6.9 (0) Maximum Zero Fuel Weight Increase).	
	7-i	Revised index.	
	7-16	Revised Figure 7-15.	
7-17	Added Warning and info.		
7-22a	Revised Figure 7-21a.		
7-34	Revised Figure 7-29.		
7-37, 7-38	Added pages; (added items 7.45 and 7.47.)		
8-11	Revised items 8.21 (d) and (e); relocated item 8.21 (e) to pg. 8-12.		
8-12	Added item from pg. 8-11.		
9-i	Revised index.		
9-6a, 9-6b	Added pages; (added Supplement 2A.)		

*Ward Evans*  
Ward Evans  
July 9, 1979

**PILOT'S OPERATING HANDBOOK LOG OF REVISIONS (cont)**

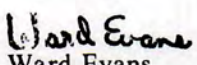
Revision Number and Code	Revised Pages	Description of Revision	FAA Approval Signature and Date
Rev. 10-761 634 (PR791005)	2-7, 2-8 2-9, 2-10 9-25, 9-26, 9-28 9-29, 9-30 9-35, 9-38 9-39	Revised para. 2.33.  Revised Supplement 6  Revised Supplement 7	 Ward Evans October 5, 1979
Rev. 14 - 761 634 (PR800725)	1-4 2-2 2-3 2-8 2-10 3-i 3-4, 3-11 3-17 4-4 4-15 5-9  5-24, 5-25 5-26, 5-26a, 5-33 6-i 6-11 6-23 6-27 6-43 6-44 6-45 6-46  6-47 6-48 6-49 6-50 6-51  6-52 6-53 6-57	Revised items 1.7 (c). Revised item 2.7 (g). Revised item 2.9 (a). Revised Strobe Light Placard. Added Fuel Tank Placards. Added para. 3.39. Revised Trim info. Added para. 3.39. Revised spelling Revised para. 4.25 info. Revised pg. nos.; added Figures 5-26 and 5-28; revised Figures 5-27, 5-29 and 5-43. Revised Figure nomenclature.  Revised pg. no; added item 6.9 (o). Revised figure 6-9. Added items 21 and 23. Added item 47. Revised item 183. Added items 189 and 190. Revised item numbers. Revised item nos; added items 206 and 208 relocated items to pg. 6-47. Added items from pg. 6-46; added new items 210 and 213; relocated items to pg. 6-48. Added items from pg. 6-47; relocated items to pg. 6-49. Added items from pg. 6-48; relocated items to pg. 6-50. Added items from pg. 6-49; relocated items to pg. 6-51. Added items from pg. 6-50; relocated items to pg. 6-52. Added items from pg. 6-51. Added items 307 and 309. Added items 392 thru 395; relocated items to pg. 6-58.	

**PILOT'S OPERATING HANDBOOK LOG OF REVISIONS (cont)**

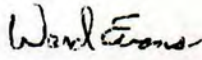
Revision Number and Code	Revised Pages	Description of Revision	FAA Approval Signature and Date
Rev. 11 - 761 634 (PR800725) (cont)	6-58	Added items from pg. 6-57; renumbered items; relocated items to pg. 6-59.	
	6-59	Added items from pg. 6-58.	
	7-4	Revised para. 7.7.	
	7-5	Relocated info. to pgs. 7-6 and 7-7; added synchrophaser info.	
	7-6	Added info. from pg. 7-5; relocated info. to pg. 7-7.	
	7-7	Added info. from pgs. 7-5 and 7-6; relocated info. to pg. 7-10.	
	7-10	Added info from pg. 7-7; relocated info. to pg. 7-11.	
	7-11	Added info. from pg. 7-10; revised para. 7.15.	
	7-23	Added info. to para. 7-23.	
	7-28	Revised para. 7.27.	
	8-10	Relocated info. to pgs. 8-10a and 8-10b.	
	8-10a, 8-10b	Added info from pg. 8-10 and info. to item 8.21 (b).	
	9-i	Added Supplements 8, 9, 10, 11, 12 and 13.	
	9-29	Deleted item (j) (7); revised item no.	
	9-35	Revised ser. numbers	
	9-39	Deleted item (j) (8); revised item no.	
	9-40	Added pg.	
	9-41 thru 9-44	Added pgs. (Added KNS 80 Navigation System)	
	9-45 thru 9-48	Added pgs. (Added ANS 351 Navigation Computer)	
	9-49 thru 9-52	Added pgs. (Added NP-2041A Area Navigation Computer Programmer).	
9-53 thru 9-56	Added pgs. (Added RDR-160 Weather Radar System)		
9-57 thru 9-60	Added pgs. (Added RDR-160/IN2026A Weather Radar System).		
9-61, 9-62	Added pgs. (Added Piper Control Wheel Clock Installation)		
Rev. 12 - 761 634 (PR801119)	5-16	Revised fig. 5-11.	 Ward Evans July 25, 1980
	5-17	Revised fig. 5-13.	
	5-19	Revised fig. 5-17.	
	6-41	Renumbered item.	
	6-42a	Renumbered items; relocated items 175 and 176 from pg. 6-43.	
	6-43	Renumbered items; moved items 175 and 176 to pg. 6-42a; relocated items 183 and 184 from pg. 6-44.	
	6-44	Renumbered items; moved items 183 and 185 to pg. 6-43; revised item 188.	
	6-45	Renumbered items; added new item 192; revised item 193; moved items 195 and 196 to pg. 6-46.	
6-46	Relocated items 195 and 196 from pg. 6-45; moved item 208 to pg. 6-47.		

**PILOT'S OPERATING HANDBOOK LOG OF REVISIONS (cont)**

Revision Number and Code	Revised Pages	Description of Revision	FAA Approval Signature and Date		
Rev. 12 - 761 634 (PR801119) (cont)	6-47	Relocated item 208 from pg. 6-46; moved item 217 to pg. 6-48.	<p align="center"><i>Ward Evans</i> Ward Evans Nov. 19, 1980</p>		
	6-48	Relocated item 217 from pg. 6-47; moved item 237 to pg. 6-49.			
	6-49	Relocated item 237 from pg. 6-48; moved item 253 to pg. 6-50.			
	6-50	Relocated item 253 from pg. 6-49.			
	6-51	Added item 290; moved item 294 to pg. 6-52.			
	6-52	Relocated item 294 from pg. 6-51.			
	9-i	Added supplement 14 and 15.			
	9-42	Revised Sec. 4 (6) (8) a and b.			
	9-50	Revised Note.			
	9-62	Revised Sec. 4 (c).			
	9-63 thru 9-66	Added supplement 14 (RCA WeatherScout II Monochrome Weather Radar).			
	9-67 thru 9-70	Added supplement 15 (RCA WeatherScout II Color Weather Radar)			
	Rev. 13 - 761 634 (PR810403)	iii		Revised applicability.	<p align="center"><i>Ward Evans</i> Ward Evans April 3, 1981</p>
		6-25		Revised item 31.	
6-27		Revised items 41 thru 47.			
6-38		Added item 134.			
6-47		Revised item 210.			
6-51		Revised item 291.			
6-57		Revised items 391 thru 395; moved items 394 and 395 to pg. 6-58.			
6-58		Relocated items 394 and 395 from pg. 6-57; revised item 396; moved items 403 and 405 to pg. 6-59.			
6-59		Relocated items 403 and 405 from pg. 6-58.			
7-28		Revised para. 7.27.			
9-47		Revised Sec. 4 (b) (1).			
9-69	Revised Sec. 1 (d) (9).				
Rev. 14 - 761 634 (PR830630)	Title	Revised text.			
	3-i, 3-ii	Revised Table of Contents.			
	3-18	Added para. 3.41.			
	4-i, 4-ii	Revised Table of Contents.			
	4-4	Revised Procedure.			
	4-6	Revised Procedure.			
	4-7	Revised Procedure.			

**PILOT'S OPERATING HANDBOOK LOG OF REVISIONS (cont)**

Revision Number and Code	Revised Pages	Description of Revision	FAA Approval Signature and Date
Rev. 14 - 761 634 (PR830630) (cont)	4-10 4-15 4-20 4-23 6-1 6-3 6-6 6-7 6-9, 6-10 6-27 6-52 7-19 7-27 7-29 7-31 7-33	Added Note to para. 4.13. Added Note to para. 4.25. Added Note to para. 4.35. Added to Warning. Revised para. 6.1. Revised para. 6.3. Revised para. 6.5. Revised Figure 6-5. Revised Figure 6-7.  Added item 49. Revised item 297. Revised para. 7.19. Revised para. 7.27. Revised para. 7.33. Relocated info. from pg. 7-33. Moved info. to pg. 7-31; added Caution.	                      <p align="center"><i>Ward Evans</i>                      Ward Evans                      June 30, 1983</p>
Rev. 15 - 761 634 (PR871130)	3-1 4-4 4-10 6-17 7-16 7-28 7-29	Revised para. 3.1. Revised para. 4.5. Revised para. 4.11. Revised para. 6.9. Revised Figure 7-15. Revised Note. Revised para. 7.31.	                     <p align="center"><i>D.H. Trompler</i>                      D.H. Trompler                      January 25, 1988                      Date</p>

## **TABLE OF CONTENTS**

<b>SECTION 1</b>	<b>GENERAL</b>
<b>SECTION 2</b>	<b>LIMITATIONS</b>
<b>SECTION 3</b>	<b>EMERGENCY PROCEDURES</b>
<b>SECTION 4</b>	<b>NORMAL PROCEDURES</b>
<b>SECTION 5</b>	<b>PERFORMANCE</b>
<b>SECTION 6</b>	<b>WEIGHT AND BALANCE</b>
<b>SECTION 7</b>	<b>DESCRIPTION AND OPERATION OF THE AIRPLANE AND ITS SYSTEMS</b>
<b>SECTION 8</b>	<b>AIRPLANE HANDLING, SERVICING AND MAINTENANCE</b>
<b>SECTION 9</b>	<b>SUPPLEMENTS</b>
<b>SECTION 10</b>	<b>SAFETY TIPS</b>

**TABLE OF CONTENTS**

**SECTION 1**

**GENERAL**

<b>Paragraph No.</b>		<b>Page No.</b>
1.1	Introduction . . . . .	1-1
1.3	Engines . . . . .	1-3
1.5	Propellers . . . . .	1-3
1.7	Fuel . . . . .	1-3
1.9	Oil . . . . .	1-4
1.11	Maximum Weights . . . . .	1-4
1.13	Standard Airplane Weights . . . . .	1-4
1.15	Baggage Space . . . . .	1-4
1.17	Specific Loadings . . . . .	1-4
1.19	Symbols, Abbreviations and Terminology . . . . .	1-5
1.21	Conversion Factors . . . . .	1-11



1911  
1912  
1913

SECTION 1

GENERAL

1.1 INTRODUCTION

This Pilot's Operating Handbook is designed for maximum utilization as an operating guide for the pilot. It includes the material required to be furnished to the pilot by FAR 23 and FAR Part 21 Subpart J. It also contains supplemental data supplied by the airplane manufacturer.

This handbook is not designed as a substitute for adequate and competent flight instruction, knowledge of current airworthiness directives, applicable federal air regulations or advisory circulars. It is not intended to be a guide for basic flight instruction or a training manual and should not be used for operational purposes unless kept in a current status.

Assurance that the airplane is in an airworthy condition is the responsibility of the owner. The pilot in command is responsible for determining that the airplane is safe for flight. The pilot is also responsible for remaining within the operating limitations as outlined by instrument markings, placards, and this handbook.

Although the arrangement of this handbook is intended to increase its in-flight capabilities, it should not be used solely as an occasional operating reference. The pilot should study the entire handbook to familiarize himself with the limitations, performance, procedures and operational handling characteristics of the airplane before flight.

The handbook has been divided into numbered (arabic) sections each provided with a "finger-tip" tab divider for quick reference. The limitations and emergency procedures have been placed ahead of the normal procedures, performance and other sections to provide easier access to information that may be required in flight. The "Emergency Procedures" Section has been furnished with a red tab divider to present an instant reference to the section. Provisions for expansion of the handbook have been made by the deliberate omission of certain paragraph numbers, figure numbers, item numbers and pages noted as being intentionally left blank.

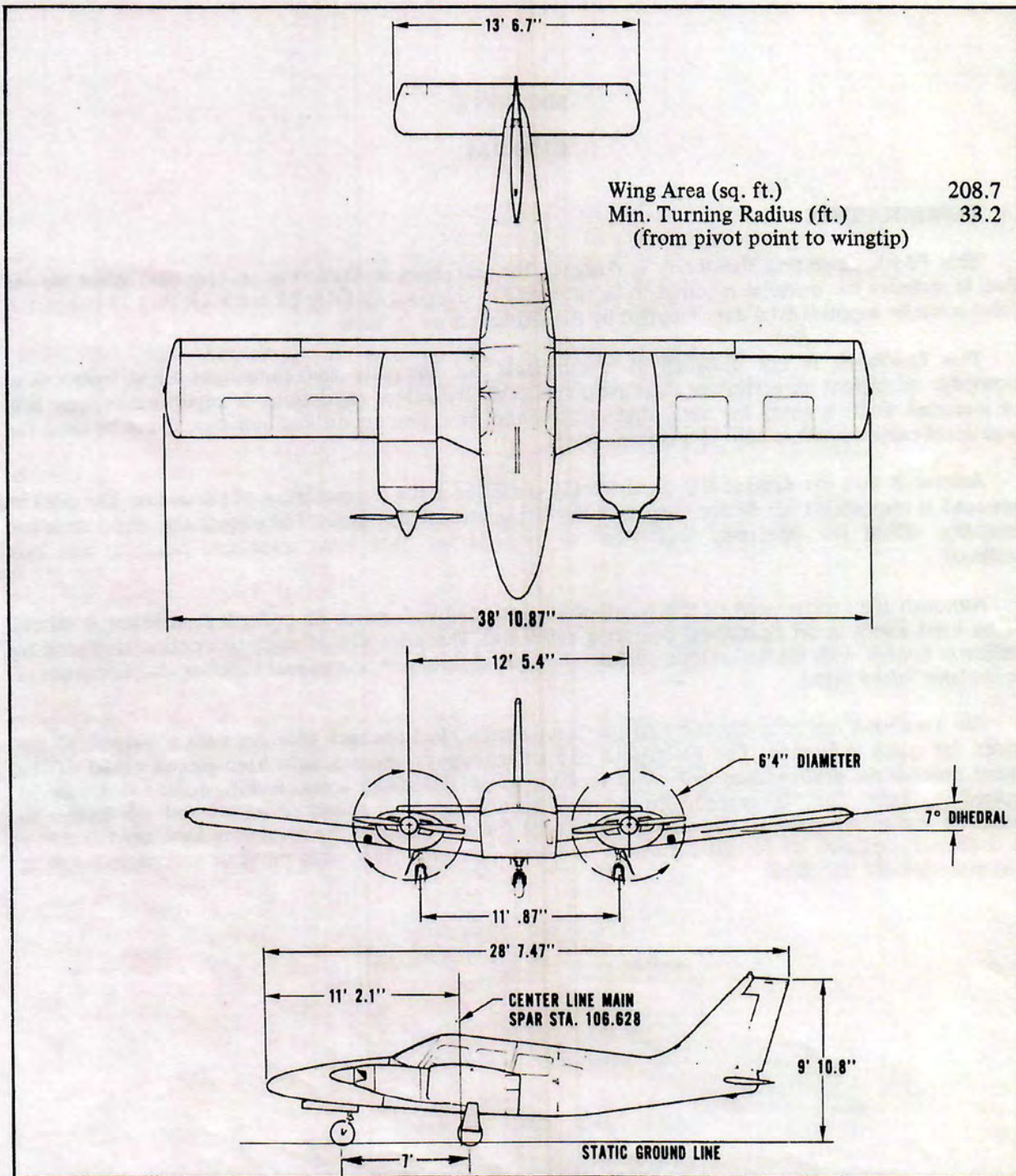

THREE VIEW

Figure 1-1

1.3 ENGINES

(a) Number of Engines	2
(b) Engine Manufacturer	Continental
(c) Engine Model Number	
(1) Left	TSIO-360E or TSIO-360EB
(2) Right	LTSIO-360E or LTSIO-360EB
(d) Rated Horsepower	
(1) Sea level	200
(2) 12,000 ft.	215
(e) Rated Speed (rpm)	2575
(f) Bore (inches)	4.438
(g) Stroke (inches)	3.875
(h) Displacement (cubic inches)	360
(i) Compression Ratio	7.5:1
(j) Engine Type	Six Cylinder, Direct Drive, Horizontally Opposed, Air Cooled

1.5 PROPELLERS

(a) Number of Propellers	2
(b) Propeller Manufacturer	
Hartzell	
(1) Propeller Hub and Blade Models	
a. Left	BHC-C2YF-2CKF/FC8459-8R
Right	BHC-C2YF-2CLKF/FJC8459-8R
b. Left	BHC-C2YF-2CKUF/FC8459-8R
Right	BHC-C2YF-2CLKUF/FJC8459-8R
When propeller deicing boots are installed:	
c. Left	BHC-C2YF-2CKF/FC8459B-8R
Right	BHC-C2YF-2CLKF/FJC8459B-8R
d. Left	BHC-C2YF-2CKUF/FC8459B-8R
Right	BHC-C2YF-2CLKUF/FJC8459B-8R
(2) Number of Blades	2
McCauley	
(1) Propeller Hub and Blade Models	
a. Left	3AF34C502/80HA-4
b. Right	3AF34C503/L80HA-4
When propeller deicing boots are installed: Same as above.	
(2) Number of Blades	3
(c) Propeller Diameter	
(1) Maximum	76
(2) Minimum	75
(d) Propeller Type	Constant Speed, Hydraulically Actuated, Full Feathering

1.7 FUEL

(a) Fuel Capacity (U.S. gal) (total)		
(1) Without optional tanks		98
(2) With optional tanks		128
(b) Usable Fuel (U.S. gal) (total)		
(1) Without optional tanks		93
(2) With optional tanks		123
(c) Fuel		
(1) Minimum Grade	100 Green or 100I.I. Blue Aviation Grade	
(2) Alternate Fuels	Refer to latest revision of Continental Service Bulletin "Fuel and Oil Grades"	

1.9 OIL

(a) Oil Capacity (U.S. quarts) (per engine)		8
(b) Oil Specification	Refer to latest issue of Continental Service Bulletin "Fuel and Oil Grades"	
(c) Oil Viscosity per Average Ambient Temp.		
(1) Below 40° F	Aviation Grade	S.A.E. No.
(2) Above 40° F	1065	30
	1100	50

When operating temperatures overlap indicated ranges, use the lighter grade of oil. Multi-viscosity oils meeting Teledyne Continental Motors' Specification MHS-24A are approved.

1.11 MAXIMUM WEIGHTS

(a) Maximum Takeoff Weight (lbs)		4570
(b) Maximum Landing Weight (lbs)		4342
(c) Maximum Zero Fuel Weight (lbs) - Standard		4000
(d) Maximum Weights in Baggage Compartments (lbs)	FORWARD	AFT
	100	100

1.13 STANDARD AIRPLANE WEIGHTS\*

(a) Standard Empty Weight (lbs): Weight of a standard airplane including unusable fuel, full operating fluids and full oil.		2823
(b) Maximum Useful Load (lbs): The difference between the Maximum Takeoff Weight and the Standard Empty Weight. (All weight in excess of 4000 lbs must consist of fuel)		1747

\*These values are approximate and vary from one aircraft to another. Refer to Figure 6-5 for the Standard Empty Weight value and the Useful Load value to be used for C.G. calculations for the aircraft specified.

1.15 BAGGAGE SPACE

	FORWARD	AFT
(a) Compartment Volume (cubic feet)	15.3	17.3
(b) Entry Width (inches)	24	
(c) Entry Height (inches)	21	

1.17 SPECIFIC LOADINGS

(a) Wing Loading (lbs per sq ft)		22
(b) Power Loading (lbs per hp)		
(1) Sea level		11.4
(2) 12,000 ft.		10.6

THIS PAGE INTENTIONALLY LEFT BLANK

### 1.19 SYMBOLS, ABBREVIATIONS AND TERMINOLOGY

The following definitions are of symbols, abbreviations and terminology used throughout the handbook and those which may be of added operational significance to the pilot.

(a) General Airspeed Terminology and Symbols

CAS	Calibrated Airspeed means the indicated speed of an aircraft, corrected for position and instrument error. Calibrated airspeed is equal to true airspeed in standard atmosphere at sea level.
KCAS	Calibrated Airspeed expressed in "Knots."
GS	Ground Speed is the speed of an airplane relative to the ground.
IAS	Indicated Airspeed is the speed of an aircraft as shown on the airspeed indicator when corrected for instrument error. IAS values published in this handbook assume zero instrument error.
KIAS	Indicated Airspeed expressed in "Knots."
M	Mach Number is the ratio of true airspeed to the speed of sound.
TAS	True Airspeed is the airspeed of an airplane relative to undisturbed air which is the CAS corrected for altitude, temperature and compressibility.
$V_A$	Maneuvering Speed is the maximum speed at which application of full available aerodynamic control will not overstress the airplane.
$V_{FE}$	Maximum Flap Extended Speed is the highest speed permissible with wing flaps in a prescribed extended position.
$V_{LE}$	Maximum Landing Gear Extended Speed is the maximum speed at which an aircraft can be safely flown with the landing gear extended.
$V_{LO}$	Maximum Landing Gear Operating Speed is the maximum speed at which the landing gear can be safely extended or retracted.
$V_{MC}$	Air minimum control speed is the minimum flight speed at which the airplane is controllable with a bank of not more than 5 degrees when one engine suddenly becomes inoperative and the remaining engine is operating at takeoff power.
$V_{NE}/M_{NE}$	Never Exceed Speed or Mach Number is the speed limit that may not be exceeded at any time.
$V_{NO}$	Maximum Structural Cruising Speed is the speed that should not be exceeded except in smooth air and then only with caution.



---

$V_S$	Stalling Speed or the minimum steady flight speed at which the airplane is controllable.
$V_{SO}$	Stalling Speed or the minimum steady flight speed at which the airplane is controllable in the landing configuration.
$V_{SSE}$	Intentional One Engine Inoperative Speed is a minimum speed selected by the manufacturer for intentionally rendering one engine inoperative in flight.
$V_X$	Best Angle-of-Climb Speed is the airspeed which delivers the greatest gain of altitude in the shortest possible horizontal distance.
$V_Y$	Best Rate-of-Climb Speed is the airspeed which delivers the greatest gain in altitude in the shortest possible time.

(b) Meteorological Terminology

ISA	International Standard Atmosphere in which: The air is a dry perfect gas; The temperature at sea level is 15° Celsius (59° Fahrenheit); The pressure at sea level is 29.92 inches hg. (1013 mb); The temperature gradient from sea level to the altitude at which the temperature is -56.5° C (-69.7° F) is -0.00198° C (-0.003566° F) per foot and zero above that altitude.
OAT	Outside Air Temperature is the free air static temperature, obtained either from inflight temperature indications or ground meteorological sources, adjusted for instrument error and compressibility effects.
Indicated Pressure Altitude	The number actually read from an altimeter when the barometric subscale has been set to 29.92 inches of mercury (1013 millibars).
Pressure Altitude	Altitude measured from standard sea-level pressure (29.92 in. Hg) by a pressure or barometric altimeter. It is the indicated pressure altitude corrected for position and instrument error. In this handbook, altimeter instrument errors are assumed to be zero.
Station Pressure	Actual atmospheric pressure at field elevation.
Wind	The wind velocities recorded as variables on the charts of this handbook are to be understood as the headwind or tailwind components of the reported winds.

(c) Power Terminology

Takeoff Power	Maximum power permissible for takeoff.
Maximum Continuous Power	Maximum power permissible continuously during flight.

Maximum Climb Power      Maximum power permissible during climb.  
Maximum Cruise Power      Maximum power permissible during cruise.

(d) Engine Instruments

EGT Gauge      Exhaust Gas Temperature Gauge

(e) Airplane Performance and Flight Planning Terminology

Climb Gradient      The demonstrated ratio of the change in height during a portion of a climb, to the horizontal distance traversed in the same time interval.

Demonstrated Crosswind Velocity (DEMO. X-WIND)      The demonstrated crosswind velocity is the velocity of the crosswind component for which adequate control of the airplane during takeoff and landing was actually demonstrated during certification tests.

Accelerate-Stop Distance      The distance required to accelerate an airplane to a specified speed and, assuming failure of an engine at the instant that speed is attained, to bring the airplane to a stop.

MEA      Minimum en route IFR altitude.

Route Segment      A part of a route. Each end of that part is identified by: (1) a geographical location; or (2) a point at which a definite radio fix can be established.

(f) Weight and Balance Terminology

Reference Datum      An imaginary vertical plane from which all horizontal distances are measured for balance purposes.

Station      A location along the airplane fuselage usually given in terms of distance from the reference datum.

Arm      The horizontal distance from the reference datum to the center of gravity (C.G.) of an item.

Moment      The product of the weight of an item multiplied by its arm. (Moment divided by a constant is used to simplify balance calculations by reducing the number of digits.)

---

Center of Gravity (C.G.)	The point at which an airplane would balance if suspended. Its distance from the reference datum is found by dividing the total moment by the total weight of the airplane.
C.G. Arm	The arm obtained by adding the airplane's individual moments and dividing the sum by the total weight.
C.G. Limits	The extreme center of gravity locations within which the airplane must be operated at a given weight.
Usable Fuel	Fuel available for flight planning.
Unusable Fuel	Fuel remaining after a runout test has been completed in accordance with governmental regulations.
Standard Empty Weight	Weight of a standard airplane including unusable fuel, full operating fluids and full oil.
Basic Empty Weight	Standard empty weight plus optional equipment.
Payload	Weight of occupants, cargo and baggage.
Useful Load	Difference between takeoff weight, or ramp weight if applicable, and basic empty weight.
Maximum Ramp Weight	Maximum weight approved for ground maneuver. (It includes weight of start, taxi and run up fuel.)
Maximum Takeoff Weight	Maximum weight approved for the start of the takeoff run.
Maximum Landing Weight	Maximum weight approved for the landing touchdown.
Maximum Zero Fuel Weight	Maximum weight exclusive of usable fuel.

THIS PAGE INTENTIONALLY LEFT BLANK

**THIS PAGE INTENTIONALLY LEFT BLANK**

1.21 CONVERSION FACTORS

<u>MULTIPLY</u>	<u>BY</u>	<u>TO OBTAIN</u>	<u>MULTIPLY</u>	<u>BY</u>	<u>TO OBTAIN</u>
acres	0.4047	ha	cubic inches (cu. in.)	16.39	cm <sup>3</sup>
	43560	sq. ft.		$1.639 \times 10^{-5}$	m <sup>3</sup>
	0.0015625	sq. mi.		$5.787 \times 10^{-4}$	cu. ft.
atmospheres (atm)	76	cm Hg	0.5541		fl. oz.
	29.92	in. Hg	0.01639		1
	1.0133	bar	$4.329 \times 10^{-3}$		U.S. gal.
	1.033	kg/cm <sup>2</sup>	0.01732		U.S. qt.
	14.70	lb./sq. in.	cubic meters (m <sup>3</sup> )	61024	cu. in.
	2116	lb./sq. ft.		1.308	cu. yd.
bars (bar)	0.98692	atm.	35.3147	cu. ft.	
	14.503768	lb./sq. in.	264.2	U.S. gal.	
British Thermal Unit (BTU)	0.2519958	kg-cal	cubic meters per minute (m <sup>3</sup> /min.)	35.3147	cu. ft./min.
centimeters (cm)	0.3937	in.	cubic yards (cu. yd.)	27	cu. ft.
	0.032808	ft.		0.7646	m <sup>3</sup>
centimeters of mercury at 0°C (cm Hg)	0.01316	atm	202	U.S. gal.	
	0.3937	in. Hg	degrees (arc)	0.01745	radians
	0.1934	lb./sq. in.		degrees per second (deg./sec.)	0.01745
	27.85	lb./sq. ft.	drams, fluid (dr. fl.)		0.125
	135.95	kg/m <sup>2</sup>		drams, avdp. (dr. avdp.)	0.0625
centimeters per second (cm/sec.)	0.032808	ft./sec.	feet (ft.)		30.48
	1.9685	ft./min.		0.3048	m
	0.02237	mph		12	in.
cubic centimeters (cm <sup>3</sup> )	0.03381	fl. oz.		0.33333	yd.
	0.06102	cu. in.		0.0606061	rod
	$3.531 \times 10^{-5}$	cu. ft.	$1.894 \times 10^{-4}$	mi.	
	0.001	1	$1.645 \times 10^{-4}$	NM	
cubic feet (cu.ft.)	$2.642 \times 10^{-4}$	U.S. gal.	feet per minute (ft./min.)	0.01136	mph
	28317	cm <sup>3</sup>		0.01829	km/hr.
	0.028317	m <sup>3</sup>		0.508	cm/sec.
	1728	cu. in.		0.00508	m/sec.
	0.037037	cu. yd.			
cubic feet per minute (cu. ft./min.)	7.481	U.S. gal.			
	28.32	1			
	0.472	1/sec.			
	0.028317	m <sup>3</sup> /min.			

**SECTION 1  
GENERAL**

**PIPER AIRCRAFT CORPORATION  
PA-34-200T, SENECA II**

<u>MULTIPLY</u>	<u>BY</u>	<u>TO OBTAIN</u>	<u>MULTIPLY</u>	<u>BY</u>	<u>TO OBTAIN</u>
feet per second (ft./sec.)	0.6818 1.097 30.48 0.5921	mph km/hr. cm/sec. kts.	hectares (ha)	2.471 107639 10000	acres sq. ft. m <sup>2</sup>
foot-pounds (ft.-lb.)	0.138255 3.24 x 10 <sup>-4</sup>	m-kg kg-cal	horsepower (hp)	33000 550 76.04 1.014	ft.-lb./min. ft.-lb./sec. m-kg/sec. metric hp
foot-pounds per minute (ft.-lb./min.)	3.030 x 10 <sup>-5</sup>	hp	horsepower, metric	75 0.9863	m-kg/sec. hp
foot-pounds per second (ft.-lb./sec.)	1.818 x 10 <sup>-5</sup>	hp	inches (in.)	25.40 2.540 0.0254 0.08333 0.027777	mm cm m ft. yd.
gallons, Imperial (Imperial gal.)	277.4 1.201 4.546	cu. in. U.S. gal. l	inches of mercury at 0°C (in. Hg)	0.033421 0.4912 70.73 345.3 2.540 25.40	atm lb./sq. in. lb./sq. ft. kg/m <sup>2</sup> cm Hg mm Hg
gallons, U.S. dry (U.S. gal. dry)	268.8 1.556 x 10 <sup>-1</sup> 1.164 4.405	cu. in. cu. ft. U.S. gal. l	inch-pounds (in.-lb.)	0.011521	m-kg
gallons, U.S. liquid (U.S. gal.)	231 0.1337 4.951 x 10 <sup>-3</sup> 3785.4 3.785 x 10 <sup>-3</sup> 3.785 0.83268 128	cu. in. cu. ft. cu. yd. cm <sup>3</sup> m <sup>3</sup> l Imperial gal. fl. oz.	kilograms (kg)	2.204622 35.27 1000	lb. oz. avdp. g
gallons per acre (gal./acre)	9.353	l/ha	kilogram-calories (kg-cal)	3.9683 3087 426.9	BTU ft.-lb. m-kg
grams (g)	0.001 0.3527 2.205 x 10 <sup>-3</sup>	kg oz. avdp. lb.	kilograms per cubic meter (kg/m <sup>3</sup> )	0.06243 0.001	lb./cu. ft. g/cm <sup>3</sup>
grams per centimeter (g/cm)	0.1 6.721 x 10 <sup>-2</sup> 5.601 x 10 <sup>-3</sup>	kg/m lb./ft. lb./in.	kilograms per hectare (kg/ha)	0.892	lb./acre
grams per cubic centimeter (g/cm <sup>3</sup> )	1000 0.03613 62.43	kg/m <sup>3</sup> lb./cu. in. lb./cu. ft.	kilograms per square centimeter (kg/cm <sup>2</sup> )	0.9678 28.96 14.22 2048	atm in. Hg lb./sq. in. lb./sq. ft.

<u>MULTIPLY</u>	<u>BY</u>	<u>TO OBTAIN</u>	<u>MULTIPLY</u>	<u>BY</u>	<u>TO OBTAIN</u>
kilograms per square meter (kg/m <sup>2</sup> )	2.896 x 10 <sup>-3</sup> 1.422 x 10 <sup>-3</sup> 0.2048	in. Hg lb./sq. in. lb./sq. ft.	meters per minute (m/min.)	0.06	km/hr.
kilometers (km)	1 x 10 <sup>-5</sup> 3280.8 0.6214 0.53996	cm ft. mi. NM	meters per second (m/sec.)	3.280840 196.8504 2.237 3.6	ft./sec. ft./min. mph km/hr.
kilometers per hour (km/hr.)	0.9113 58.68 0.53996 0.6214 0.27778 16.67	ft./sec. ft./min. kt mph m/sec. m/min.	microns	3.937 x 10 <sup>-5</sup>	in.
knots (kt)	1 1.689 1.1516 1.852 51.48	nautical mph ft./sec. statute mph km/hr. m/sec.	miles, statute (mi.)	5280 1.6093 1609.3 0.8684	ft. km m NM
liters (l)	1000 61.02 0.03531 33.814 0.264172 0.2200 1.05669	cm <sup>3</sup> cu. in. cu. ft. fl. oz. U.S. gal. Imperial gal. qt.	miles per hour (mph)	44.7041 4.470 x 10 <sup>-1</sup> 1.467 88 1.6093 0.8684	cm/sec. m/sec. ft./sec. ft./min. km/hr. kt
liters per hectare (l/ha)	13.69 0.107	fl. oz./acre gal./acre	miles per hour square (m/hr. sq.)	2.151	ft./sec. sq.
liters per second (l/sec.)	2.12	cu. ft./min.	millibars	2.953 x 10 <sup>-2</sup>	in. Hg
meters (m)	39.37 3.280840 1.0936 0.198838 6.214 x 10 <sup>-4</sup> 5.3996 x 10 <sup>-4</sup>	in. ft. yd. rod mi. NM	millimeters (mm)	0.03937	in.
meter-kilogram (m-kg)	7.23301 86.798	ft.-lb. in.-lb.	millimeters of mercury at 0°C (mm Hg)	0.03937	in. Hg
			nautical miles (NM)	6080 1.1516 1852 1.852	ft. statute mi. m km
			ounces, avdp. (oz. avdp.)	28.35 16	g dr. avdp.
			ounces, fluid (fl. oz.)	8 29.57 1.805 0.0296 0.0078	dr. fl. cm <sup>3</sup> cu. in. l U.S. gal.



**SECTION 1  
GENERAL**

**PIPER AIRCRAFT CORPORATION  
PA-34-200T, SENECA II**

<u>MULTIPLY</u>	<u>BY</u>	<u>TO OBTAIN</u>	<u>MULTIPLY</u>	<u>BY</u>	<u>TO OBTAIN</u>
ounces, fluid per acre (fl. oz./acre)	0.073	l/ha	rod	16.5 5.5 5.029	ft. yd. m
pounds (lb.)	0.453592 453.6 $3.108 \times 10^{-2}$	kg g slug	slug	32.174	lb.
pounds per acre (lb./acre)	1.121	kg/ha	square centimeters (cm <sup>2</sup> )	0.1550 0.001076	sq. in. sq. ft.
pounds per cubic foot (lb./cu. ft.)	16.02	kg/m <sup>3</sup>	square feet (sq. ft.)	929 0.092903 144 0.1111 $2.296 \times 10^{-5}$	cm <sup>2</sup> m <sup>2</sup> sq. in. sq. yd. acres
pounds per cubic inch (lb./cu. in.)	1728 27.68	lb./cu. ft. g/cm <sup>3</sup>	square inches (sq. in.)	6.4516 $6.944 \times 10^{-3}$	cm <sup>2</sup> sq. ft.
pounds per square foot (lb./sq. ft.)	0.1414 4.88243 $4.725 \times 10^{-4}$	in. Hg kg/m <sup>2</sup> atm	square kilometers (km <sup>2</sup> )	0.3861	sq. mi.
pounds per square inch (psi or lb./sq. in.)	5.1715 2.036 0.06804 0.0689476 703.1	cm Hg in. Hg atm bar kg/m <sup>2</sup>	square meters (m <sup>2</sup> )	10.76391 1.196 0.0001	sq. ft. sq. yd. ha
quart, U.S. (qt.)	0.94635 57.749	l cu. in.	square miles (sq. mi.)	2.590 640	km <sup>2</sup> acres
radians	57.30 0.1592	deg. (arc) rev.	square rods (sq. rods)	30.25	sq. yd.
radians per second (radians/sec.)	57.30 0.1592 9.549	deg./sec. rev./sec. rpm	square yards (sq. yd.)	0.8361 9 0.0330579	m <sup>2</sup> sq. ft. sq. rods
revolutions (rev.)	6.283	radians	yards (yd.)	0.9144 3 36 0.181818	m ft. in. rod
revolutions per minute (rpm or rev./min.)	0.1047	radians/sec.			
revolutions per second (rev./sec.)	6.283	radians/sec.			

**TABLE OF CONTENTS**

**SECTION 2**

**LIMITATIONS**

Paragraph No.		Page No.
2.1	General . . . . .	2-1
2.3	Airspeed Limitations . . . . .	2-1
2.5	Airspeed Indicator Marking . . . . .	2-2
2.7	Power Plant Limitations . . . . .	2-2
2.9	Power Plant Instrument Markings . . . . .	2-4
2.11	Weight Limits . . . . .	2-4
2.13	Center of Gravity Limits . . . . .	2-5
2.15	Maneuver Limits . . . . .	2-5
2.17	Flight Load Factor Limits (Flaps Up) . . . . .	2-5
2.19	Types of Operation . . . . .	2-5
2.21	Fuel Limitations . . . . .	2-6
2.23	Gyro Pressure Limits . . . . .	2-6
2.25	Flight Into Known Icing Conditions . . . . .	2-6
2.27	Heater Limitations . . . . .	2-6
2.29	Operating Altitude Limitations . . . . .	2-6
2.31	Noise Level . . . . .	2-7
2.33	Placards . . . . .	2-7

to  
the  
the



SECTION 2  
LIMITATIONS

2.1 GENERAL

This section provides the "FAA Approved" operating limitations, instrument markings, color coding and basic placards necessary for the safe operation of the PA-34-200T Seneca II and its systems.

Limitations associated with those optional systems and equipment which require handbook supplements can be found in Section 9 (Supplements).

2.3 AIRSPEED LIMITATIONS

SPEED	KIAS	KCAS
Never Exceed Speed ( $V_{NE}$ ) - Do not exceed this speed in any operation.	195	195
Maximum Structural Cruising Speed ( $V_{NO}$ ) - Do not exceed this speed except in smooth air and then only with caution.	163	165
Design Maneuvering Speed ( $V_A$ ) - Do not make full or abrupt control movements above this speed.		
At 4570 LBS. G.W.	136	138
At 3068 LBS. G.W.	121	122

CAUTION

Maneuvering speed decreases at lighter weight as the effects of aerodynamic forces become more pronounced. Linear interpolation may be used for intermediate gross weights. Maneuvering speed should not be exceeded while operating in rough air.

Maximum Flaps Extended Speed ( $V_{FE}$ ) - Do not exceed this speed with flaps extended.	107	109
Maximum Gear Extended Speed ( $V_{LE}$ ) - Do not exceed this speed with landing gear extended.	129	130
Maximum Landing Gear Extending Speed ( $V_{LO}$ ) - Do not extend landing gear above this speed.	129	130

**SECTION 2  
LIMITATIONS**

**PIPER AIRCRAFT CORPORATION  
PA-34-200T, SENECA II**

	KIAS	KCAS
Maximum Landing Gear Retracting Speed ( $V_{LO}$ ) - Do not retract landing gear above this speed.	107	109
Air Minimum Control Speed ( $V_{MC}$ ) - Lowest airspeed at which airplane is controllable with one engine operating and no flaps.	66	69
Best Single Engine Rate of Climb Speed	89	90

**2.5 AIRSPEED INDICATOR MARKINGS**

MARKING	KIAS
Green Arc (Normal Operating Range)	63 to 163
Yellow Arc (Caution Range - Smooth Air)	163 to 195
White Arc (Flaps Extended Range)	61 to 107
Radial Red Line (Never Exceed - Smooth Air)	195
Radial Red Line (Minimum Control Speed - Single Engine)	<del>66</del>
Radial Blue Line (Best Rate of Climb Speed - Single Engine)	89

**2.7 POWER PLANT LIMITATIONS**

(a) Number of Engines	2
(b) Engine Manufacturer	Continental
(c) Engine Model Number	TSIO-360E or TSIO-360EB LTSIO-360E or LTSIO-360EB
(d) Engine Operating Limits	
(1) Rated Horsepower	
Sea level	200
12,000 ft.	215
(2) Maximum Rotational Speed (RPM)	2575
(3) Maximum Manifold Pressure (Inches of Mercury)	40
(4) Maximum Cylinder Head Temperature	460°F
(5) Maximum Oil Temperature	240°F
(e) Oil Pressure	
Minimum (red line)	10 PSI
Maximum (red line)	100 PSI
(f) Fuel Flow	
Normal Operating Range (green arc)	3.5 PSI to 20 PSI
Maximum at Sea Level (red line)	25 GPH (20 PSI)
(g) Fuel (minimum grade)	100 or 100LL Aviation Grade
(h) Number of Propellers	2

(i) Propeller Manufacturer:  
Hartzell

Propeller Hub and Blade Models

- a. Left
- Right
- b. Left
- Right

BHC-C2YF-2CKF/FC8459-8R  
BHC-C2YF-2CLKF/FJC8459-8R  
BHC-C2YF-2CKUF/FC8459-8R  
BHC-C2YF-2CLKUF/FJC8459-8R

When propeller deicing boots are installed:

- c. Left
- Right
- d. Left
- Right

BHC-C2YF-2CKF/FC8459B-8R  
BHC-C2YF-2CLKF/FJC8459B-8R  
BHC-C2YF-2CKUF/FC8459B-8R  
BHC-C2YF-2CLKUF/FJC8459B-8R

NOTES

Avoid continuous operation between 2000 and 2200 RPM above  
32 IN. HG. manifold pressure.

Avoid continuous ground operation between 1700 and 2100 RPM  
in cross and tail winds over 10 knots.

McCauley

Propeller Hub and Blade Models

- a. Left
- b. Right

3AF34C502/80HA-4  
3AF34C503/L80HA-4

When propeller deicing boots are installed: Same as above.

(j) Propeller Diameter (inches)

Maximum  
Minimum

76  
75

2.9 POWER PLANT INSTRUMENT MARKINGS

- (a) Tachometer  
Green Arc (Normal Operating Range)  
Red Line (Maximum)

500 RPM to 2575 RPM  
2575 RPM

**SECTION 2  
LIMITATIONS**

**PIPER AIRCRAFT CORPORATION  
PA-34-200T, SENECA II**

(b) Fuel Flow and Pressure	
Green Arc (Normal Operating Range)	
Red Line (Maximum at Sea Level)	3.5 PSI to 20 PSI
Red Line (Minimum)	25 GPH (20 PSI) 3.5 PSI
(c) Cylinder Head Temperature	
Green Arc (Normal Range)	
Red Line (Maximum)	either 360° F to 460° F or 240° F to 440° F 460° F
(d) Oil Temperature	
Green Arc (Normal Operating Range)	
Red Line (Maximum)	either 75° F to 240° F or 100° F to 240° F 240° F
(e) Oil Pressure	
Green Arc (Normal Operating Range)	
Yellow Arc (Caution)	either 30 PSI to 80 PSI or 30 PSI to 60 PSI 10 PSI to 30 PSI and, either 80 PSI to 100 PSI or 60 PSI to 100 PSI 10 PSI 100 PSI
Red Line (Minimum)	
Red Line (Maximum)	
(f) Manifold Pressure	
Green Arc (Normal Operating Range)	
Red Line (Maximum)	10 IN. to 40 IN. HG. 40 IN. HG.
(g) Exhaust Gas Temperature	
Red Line	1650° F

**2.11 WEIGHT LIMITS**

(a) Maximum Takeoff Weight	
(b) Maximum Landing Weight	4570 LBS
(c) Maximum Weights in Baggage Compartments	4342 LBS
Forward	
Aft	100 LBS
(d) Maximum Zero Fuel Weight - Standard (See page 6.61 and 6-62.)	100 LBS 4000 LBS

### 2.13 CENTER OF GRAVITY LIMITS

Weight Pounds	Forward Limit Inches Aft of Datum	Aft Limit Inches Aft of Datum
3400	82.0	94.6
4570	90.6	94.6

#### NOTES

Straight line variation between the points given.

Datum is 78.4 inches forward of wing leading edge from the inboard edge of the inboard fuel tank.

It is the responsibility of the airplane owner and the pilot to assure that the airplane is properly loaded. Maximum allowable gross weight is 4570 pounds. See "Weight and Balance Section" for proper loading instructions.

### 2.15 MANEUVER LIMITS

All intentional acrobatic maneuvers (including spins) are prohibited. Avoid abrupt maneuvers.

### 2.17 FLIGHT LOAD FACTOR LIMITS (Flaps Up)

- |                                    |                                |
|------------------------------------|--------------------------------|
| (a) Positive Load Factor (Maximum) | 3.8 G                          |
| (b) Negative Load Factor (Maximum) | No inverted maneuvers approved |

### 2.19 TYPES OF OPERATIONS

The airplane is approved for the following operations when equipped in accordance with FAR 91 or FAR 135.

- (a) Day V.F.R.
- (b) Night V.F.R.
- (c) Day I.F.R.
- (d) Night I.F.R.
- (e) Icing conditions when equipped per Section 2.25.



### **2.21. FUEL LIMITATIONS**

- (a) **Unusable Fuel**  
The unusable fuel in this aircraft has been determined as 2.5 gallons in each wing in critical flight attitudes (2.5 gallons is the total per side, each side having interconnected tanks).
- (b) **Usable Fuel**  
The usable fuel in this aircraft has been determined as 46.5 gallons in each wing or a total of 93 gallons with standard fuel tanks and 61.5 gallons in each wing or a total of 123 gallons with optional fuel tanks installed.

### **2.23 GYRO PRESSURE LIMITS**

The operating limits for the pressure system are 4.5 to 5.2 inches of mercury for all operations as indicated by the gyro pressure gauge.

### **2.25 FLIGHT INTO KNOWN ICING CONDITIONS**

For flight in icing conditions the following equipment must be installed in accordance with Piper drawings or in an FAA approved manner:

- (a) Pneumatic wing and empennage boots
- (b) Electrothermal propeller boots
- (c) Electric windshield panel
- (d) Heated pitot head
- (e) Wing ice light
- (f) Heated lift detectors
- (g) Propeller spinners must be installed.

### **2.27 HEATER LIMITATIONS**

Operation of the combustion heater above 25,000 feet is not approved.

### **2.29 OPERATING ALTITUDE LIMITATIONS**

Flight above 25,000 feet is not approved. Flight up to and including 25,000 feet is approved if equipped with oxygen in accordance with FAR 23.1441 and avionics in accordance with FAR 91 or FAR 135.

### **2.31 NOISE LEVEL**

The noise level of this aircraft is 73.5 dB(A) when equipped with two bladed propellers and 76.4 dB(A) when equipped with three bladed propellers.

No determination has been made by the Federal Aviation Administration that the noise levels of this airplane are or should be acceptable or unacceptable for operation at, into, or out of, any airport.

The above statement notwithstanding, the noise level stated above has been verified by and approved by the Federal Aviation Administration in noise level test flights conducted in accordance with FAR 36. Noise Standards - Aircraft Type and Airworthiness Certificaton. This aircraft model is in compliance with all FAR 36 noise standards applicable to this type.

### 2.33 PLACARDS

In full view of the pilot:

THIS AIRPLANE MUST BE OPERATED AS A NORMAL CATEGORY AIRPLANE IN COMPLIANCE WITH THE OPERATING LIMITATIONS STATED IN THE FORM OF PLACARDS, MARKINGS, AND MANUALS. NO ACROBATIC MANEUVERS (INCLUDING SPINS) APPROVED.

THIS AIRCRAFT APPROVED FOR V.F.R., I.F.R., DAY, NIGHT AND ICING FLIGHT WHEN EQUIPPED IN ACCORDANCE WITH FAR 91 OR FAR 135.

In full view of the pilot:

MAXIMUM TAKEOFF WEIGHT 4570 POUNDS  
MAXIMUM LANDING WEIGHT 4342 POUNDS  
ALL WEIGHT IN EXCESS OF 4000 POUNDS MUST CONSIST OF FUEL.

OR

MAXIMUM TAKEOFF WEIGHT 4570 POUNDS  
MAXIMUM LANDING WEIGHT 4342 POUNDS  
ALL WEIGHT IN EXCESS OF 4000 POUNDS MUST CONSIST OF FUEL, (EXCEPT IN CASES SPECIFIED BY SECTION 6 OF P.O.H.).

MINIMUM SINGLE ENGINE CONTROL SPEED 60 KIAS

On instrument panel in full view of the pilot:

MANEUVERING SPEED      OR      V<sub>A</sub> 136 AT 4570 LBS.  
136 KIAS AT 4570      (See P.O.H.)  
LBS. (SEE P.O.H.)

GEAR DOWN 129 KIAS (MAX.)      OR      V<sub>LO</sub> 129 DN, 107 UP  
GEAR UP 107 KIAS (MAX.)      V<sub>LE</sub> 129 MAX.  
EXTENDED 129 KIAS (MAX.)

DEMONSTRATED CROSSWIND COMPONENT 17 KTS  
OR  
DEMO X-WIND 17 KTS

Near emergency gear release:

**EMERGENCY GEAR EXTENSION  
PULL TO RELEASE. SEE P.O.H.  
BEFORE RE-ENGAGEMENT**

Near gear selector switch:

**GEAR UP  
DOWN**

**107 KIAS MAX.  
129 KIAS MAX.**

Adjacent to upper door latch (Front and rear doors):

**ENGAGE LATCH BEFORE FLIGHT**

In full view of pilot:

**WARNING - TURN OFF STROBE LIGHTS WHEN TAXIING  
IN VICINITY OF OTHER AIRCRAFT, OR DURING FLIGHT  
THROUGH CLOUD, FOG OR HAZE.**

On the inside of forward baggage compartment door:

**MAXIMUM BAGGAGE THIS COMPARTMENT 100 LBS. SEE  
THE LIMITATIONS SECTION OF THE PILOT'S OPERATING  
HANDBOOK.**

On aft baggage closeout:

**MAXIMUM BAGGAGE THIS COMPARTMENT 100 LBS. NO  
HEAVY OBJECTS ON HAT SHELF.**

On instrument panel:

**SINGLE ENGINE STALLS NOT RECOMMENDED. CAN  
CAUSE 500 FT. LOSS OF ALTITUDE AND 15° PITCH  
ANGLE.**

On instrument panel or sun visor:

**TAKEOFF CHECK LIST**

Fuel Selectors On  
Aux. Fuel Pump Off  
Alternators On  
Engine Gages Checked  
Mixtures Set  
Propellers Set  
Alt. Air Off  
Cowl Flaps Open  
Seat Backs Erect  
Flaps Set  
Trim Set (Stab. & Rudder)  
Fasten Belts/Harness  
Controls Free - Full Travel  
Doors Latched / Air Cond. Off

**LANDING CHECK LIST**

Seat Backs Erect  
Fasten Belts/Harness  
Fuel Selectors On  
Cowl Flaps Set  
Mixtures Rich  
Aux. Fuel Pump Off  
Propellers Set  
Gear Down  
Flap Set - 107 KIAS Max.  
Air Conditioner Off  
OR

**\*LANDING CHECK LIST**

Seat Backs Erect  
Fasten Belts/Harness  
Fuel Selectors On  
Cowl Flaps Set  
Mixtures Rich  
Aux. Fuel Pump Off  
Propellers Set  
Gear Down  
Flap Set - (White Arc)  
Air Conditioner Off\*

The "Air Conditioner Off" item in the above takeoff and landing check lists is mandatory for air conditioned aircraft only.

On storm window:

**DO NOT OPEN ABOVE 129 KIAS**

Near windshield panel heat switch with windshield heating installation:

**WINDSHIELD PANEL HEAT - SEE PILOT'S OPERATING  
HANDBOOK.**

On engine instrument panel cover to left of engine controls with windshield heating installation without the entire Ice Protection System installed:

**WARNING - THIS AIRCRAFT IS NOT APPROVED FOR  
FLIGHT IN ICING CONDITIONS.**

In full view of the pilot for flight with the aft fuselage doors removed:

**FOR FLIGHT WITH AFT DOORS REMOVED, CONSULT THE  
LIMITATIONS AND PROCEDURES SECTIONS OF THE  
PILOT'S OPERATING HANDBOOK.**

Beneath the pitot heat switch:

**GND. OPP.  
3 MIN. MAX.**

On the inside of both oil filler access doors:

**OIL COOLER WINTERIZATION PLATE TO BE REMOVED  
WHEN AMBIENT TEMPERATURE EXCEEDS 50°F.**

On the throttle quadrant below engine and propeller controls:

**USE PROP SYNC MANUAL FOR TAKE-OFF LANDING AND  
SINGLE ENGINE OPERATIONS.**

On the executive writing table:

**CAUTION - THIS TABLE MUST BE STOWED DURING  
TAKEOFF AND LANDING.**

On the instrument panel in full view of the pilot:

**AVOID CONTINUOUS GROUND OPERATION 1700 - 2100  
RPM IN CROSS/TAIL WIND OVER 10 KT**

**AVOID CONTINUOUS OPERATIONS 2000 - 2200 RPM  
ABOVE 32" MANIFOLD PRESSURE**

Adjacent to fuel tank fill caps with standard fuel tanks installed:

**FUEL - 100/130 AVIATION GRADE - USABLE CAPACITY  
46.5 GAL.**

**OR**

**FUEL - 100 OR 100LL AVIATION GRADE**

Adjacent to fuel tank filler caps with optional fuel tank installed:

**FUEL - 100/130 AVIATION GRADE - USABLE CAPACITY  
61.5 GAL.**

**OR**

**FUEL - 100 OR 100LL AVIATION GRADE**

- 1) Revise the FAA-approved Airplane Flight Manual (AFM) by incorporating the following into the Limitations Section of the AFM. This may be accomplished by inserting a copy of this AD in the AFM.

### **"WARNING**

Severe icing may result from environmental conditions outside of those for which the airplane is certificated. Flight in freezing rain, freezing drizzle, or mixed icing conditions (supercooled liquid water and ice crystals) may result in ice build-up on protected surfaces exceeding the capability of the ice protection system, or may result in ice forming aft of the protected surfaces. This ice may not be shed using the ice protection systems, and may seriously degrade the performance and controllability of the airplane.

During flight, severe icing conditions that exceed those for which the airplane is certificated shall be determined by the following visual cues. If one or more of these visual cues exists, immediately request priority handling from Air Traffic Control to facilitate a route or an altitude change to exit the icing conditions.

- Unusually extensive ice accumulation on the airframe and windshield in areas not normally observed to collect ice.
- Accumulation of ice on the upper surface of the wing, aft of the protected area.
- Accumulation of ice on the engine nacelles and propeller spinners farther aft than normally observed.

Since the autopilot, when installed and operating, may mask tactile cues that indicate adverse changes in handling characteristics, use of the autopilot is prohibited when any of the visual cues specified above exist, or when unusual lateral trim requirements or autopilot trim warnings are encountered while the airplane is in icing conditions.

All wing icing inspection lights must be operative prior to flight into known or forecast icing conditions at night. [NOTE: This supersedes any relief provided by the Master Minimum Equipment List (MMEL).]"

**TABLE OF CONTENTS**  
**SECTION 3**  
**EMERGENCY PROCEDURES**

Paragraph No.		Page No.
3.1	General .....	3-1
3.3	Emergency Checklist .....	3-3
	Airspeeds For Safe Operations .....	3-3
	Engine Inoperative Procedures .....	3-3
	Engine Fire On Ground .....	3-5
	Engine Fire In Flight .....	3-5
	Fuel Management During Single Engine Operation .....	3-5
	Engine Driven Fuel Pump Failure .....	3-6
	Landing Gear Unsafe Warning .....	3-6
	Manual Extension of Landing Gear .....	3-6
	Alternator Failure In Icing Conditions .....	3-6
	Engine Failure With Rear Cabin and Cargo Door Removed .....	3-6
	Electrical Failures .....	3-7
	Gyro Pressure Failures .....	3-7
	Combustion Heater Overheat .....	3-7
	Spins .....	3-7
	Emergency Descent .....	3-7
3.5	Amplified Emergency Procedures (General) .....	3-9
3.7	Engine Inoperative Procedures .....	3-9
	Detecting A Dead Engine .....	3-9
	Engine Securing Procedure (Feathering Procedure) .....	3-9
	Engine Failure During Takeoff (Below 85 KIAS) .....	3-10
	Engine Failure During Takeoff (85 KIAS or above) .....	3-10
	Engine Failure During Climb .....	3-10
	Engine Failure During Flight (Below 66 KIAS) .....	3-11
	Engine Failure During Flight (Above 66 KIAS) .....	3-11
	Single Engine Landing .....	3-11
	Single Engine Go-Around .....	3-12
	Air Start (Unfeathering Procedure) .....	3-12
3.9	Engine Fire .....	3-12
3.11	Fuel Management During Single Engine Operation .....	3-13
3.13	Engine Driven Fuel Pump Failure .....	3-14
3.15	Landing Gear Unsafe Warnings .....	3-14
3.17	Manual Extension of the Landing Gear .....	3-14
3.19	Gear Up Emergency Landing .....	3-15
3.21	Engine Failure In Icing Conditions .....	3-15
3.23	Alternator Failure In Icing Conditions .....	3-15

**TABLE OF CONTENTS (cont)**

**SECTION 3 (cont)**

<b>Paragraph No.</b>		<b>Page No.</b>
3.25	Engine Failure With Rear Cabin And Cargo Doors Removed .....	3-15
3.27	Electrical Failures .....	3-16
3.29	Gyro Pressure Failures .....	3-16
3.31	Combustion Heater Overheat .....	3-16
3.33	Spin Recovery .....	3-17
3.35	Emergency Descent .....	3-17
3.37	Door Open On Takeoff .....	3-17
3.39	Dual Alternator Failure .....	3-17
3.41	Wing-Tail Deicer Panel Light .....	3-18



**SECTION 3  
EMERGENCY PROCEDURES**

**3.1 GENERAL**

The recommended procedures for coping with various types of emergencies and critical situations are provided in this section. All of the required (FAA regulations) emergency procedures and those necessary for operation of the airplane as determined by the operating and design features of the airplane are presented.

Emergency procedures associated with those optional systems and equipment which require handbook supplements are provided in Section 9 (Supplements).

The first portion of this section consists of an abbreviated emergency check list which supplies an action sequence for critical situations with little emphasis on the operation of systems.

The remainder of the section presents amplified emergency procedures containing additional information to provide the pilot with a more complete understanding of the procedures.

These procedures are suggested as a course of action for coping with the particular condition described, but are not a substitute for sound judgment and common sense. Pilots should familiarize themselves with the procedures given in this section and be prepared to take appropriate action should an emergency arise.

Most basic emergency procedures, such as power off landings, are a normal part of pilot training. Although these emergencies are discussed here, this information is not intended to replace such training, but only to provide a source of reference and review, and to provide information on procedures which are not the same for all aircraft. It is suggested that the pilot review standard emergency procedures periodically to remain proficient in them.

**THIS PAGE INTENTIONALLY LEFT BLANK**

**3.3 EMERGENCY CHECK LIST**

**AIRSPEDS FOR SAFE OPERATIONS**

Minimum Single Engine  
Control . . . . . 66 KIAS  
Best Single Engine Rate  
of Climb . . . . . 89 KIAS  
Best Single Engine  
Angle of Climb . . . . . 78 KIAS  
Maneuvering . . . . . 121 KIAS  
Never Exceed . . . . . 195 KIAS

**ENGINE INOPERATIVE PROCEDURES**

**DETECTING DEAD ENGINE**

Loss of thrust.  
Nose of aircraft will yaw in direction of dead engine  
(with coordinated controls).

**ENGINE SECURING PROCEDURE  
(FEATHERING PROCEDURE)**

To attempt to restore power prior to feathering:  
Mixtures . . . . . as required  
Fuel selector . . . . . cross feed  
Magnetos . . . . . left or right only  
Alternate air . . . . . ON  
Auxiliary fuel pump . . . . . unlatch,  
on HI, if power is not  
immediately restored, OFF

Feather before RPM drops below 800.  
Minimum control speed . . . . . 66 KIAS  
Best S.E. R/C . . . . . 89 KIAS  
Maintain direction and airspeed above 76 KIAS.  
Mixture controls . . . . . forward  
Propeller controls . . . . . forward  
Throttle controls . . . . . forward  
(40 in Hg max.)  
Flaps . . . . . retract  
Gear . . . . . retract  
Identify inoperative engine.  
Throttle of inop. engine . . . . . retard  
to verify  
Mixture of inop. engine . . . . . idle  
cut-off

Prop control of inop. engine . . . . . feather  
Trim . . . . . as required  
Auxiliary fuel pumps . . . . . OFF  
(except in case of  
engine driven pump  
failure)  
Magnetos of inop. engine . . . . . OFF  
Cowl flaps . . . . . close on inop.  
engine, as required  
on operative engine  
Alternator of inop. engine . . . . . OFF  
Electrical load . . . . . reduce  
Fuel management . . . . . OFF inop.  
engine, consider crossfeed

**ENGINE FAILURE DURING TAKEOFF  
(Below 85 KIAS)**

If engine failure occurs during takeoff and 85 KIAS  
has not been attained:

Throttles . . . . . CLOSE both  
immediately

Stop straight ahead.

If inadequate runway remains to stop:

Throttles . . . . . CLOSED  
Brakes . . . . . apply max.  
braking

Master switch . . . . . OFF  
Fuel selectors . . . . . OFF  
Continue straight ahead, turning to avoid obstacles.

**ENGINE FAILURE DURING TAKEOFF  
(85 KIAS or above)**

If engine failure occurs during takeoff ground roll  
or after lift-off with gear still down and 85 KIAS  
has been attained:

If adequate runway remains CLOSE both throttles  
immediately, land if airborne and stop straight  
ahead.

If runway remaining is inadequate for stopping,  
decide whether to abort or continue. If decision is  
made to continue, maintain heading and airspeed,  
retract landing gear when climb is established and  
feather inoperative engine prop (see Engine  
Securing Procedure).

**ENGINE FAILURE DURING CLIMB**

If engine failure occurs when airspeed is below 66 KIAS:

- Rudder . . . . . apply towards operating engine
- Throttles . . . . . reduce throttle settings as required to maintain directional control
- Nose . . . . . lower nose to accelerate best single engine rate of climb speed (89 KIAS)
- Operative eng. . . . . increase power as airspeed increases above 66 KIAS
- Inoperative engine prop . . . . . FEATHER (see Engine Securing Procedure)

If engine failure occurs when airspeed is above 66 KIAS:

- Maintain directional control.
- Adjust airspeed toward the best single engine rate of climb speed (89 KIAS).
- Inoperative engine prop . . . . . FEATHER (see Engine Securing Procedure)

**ENGINE FAILURE DURING FLIGHT  
(Below 66 KIAS)**

- Rudder . . . . . apply towards operative engine
- Throttles (both engines) . . . . . retard to stop turn
- Pitch attitude . . . . . lower nose to accelerate above 66 KIAS
- Operative eng . . . . . increase power as airspeed increases above 66 KIAS

If altitude permits, a restart may be attempted.

If restart fails or altitude does not permit:

- Inop. eng. prop . . . . . FEATHER
- Trim . . . . . adjust 5° bank toward operative eng.
- Inop. eng. . . . . complete Engine Securing Procedure
- Cowl flap (operative eng.) . . . . . as required

**ENGINE FAILURE DURING FLIGHT  
(Above 66 KIAS)**

- Rudder . . . . . apply toward operative engine
- Inop. eng. . . . . identify
- Operative eng. . . . . adjust as required

Before securing inop. engine:

- Fuel flow . . . . . check (if deficient- auxiliary fuel pump HI BOOST. if power is not restored, OFF
- Fuel quantity . . . . . check
- Fuel selector (inop. eng.) . . . . . cross feed
- Alternate air . . . . . ON
- Mixture . . . . . check
- Oil pressure and temp . . . . . check
- Magneto switches . . . . . check
- If engine does not start, complete Engine Securing Procedure.

- Power (operative eng.) . . . . . as required
- Mixture (operative eng.) . . . . . adjust for power
- Fuel quantity (operative eng. tank) . . . . . sufficient
- Auxiliary fuel pump (operative eng.) . . . . . as required
- Cowl flap (operative eng.) . . . . . as required
- Trim (Rudder) . . . . . adjust 5° bank toward operative eng.
- Electrical load . . . . . decrease to min. required
- Land as soon as practical at nearest suitable airport.

**SINGLE ENGINE LANDING**

- Inop. engine prop . . . . . feather
- When certain of making field:
- Landing gear . . . . . extend
- Wing flaps . . . . . lower
- Maintain additional altitude and speed during approach.
- Final approach speed . . . . . 91 KIAS
- Wing flaps . . . . . 25°

**SINGLE ENGINE GO-AROUND (Avoid if at all possible.)**

Mixture . . . . . forward  
Propeller . . . . . forward  
Throttle . . . . . open slowly  
                                to 40 in Hg  
Flaps . . . . . retract  
Landing gear . . . . . retract  
Airspeed . . . . . 89 KIAS  
Trim . . . . . set  
Cowl flap operating engine . . . . . as  
  required

**AIR START (UNFEATHERING PROCEDURE)**

Fuel selector inop. engine . . . . . ON  
Aux. fuel pump inop. engine . . . . . OFF  
Throttle . . . . . open 1/4 inch  
Prop control . . . . . forward to  
                                cruise RPM position  
Mixture . . . . . RICH  
Magneto switches . . . . . ON  
Starter . . . . . engage until  
                                prop windmills  
Throttle . . . . . reduce power until  
                                engine is warm  
If engine does not start, prime as required.  
Alternator . . . . . ON

**ENGINE FIRE ON GROUND**

If engine has not started:  
Mixture . . . . . idle cut-off  
Throttle . . . . . open  
Starter . . . . . crank engine

If engine has already started and is running,  
continue operating to try pulling the fire into the  
engine.

If fire continues, extinguish with best available  
means.

If external fire extinguishing is to be applied:  
Fuel selector valves . . . . . OFF  
Mixture . . . . . idle cut-off

**ENGINE FIRE IN FLIGHT**

Affected engine:  
Fuel selector . . . . . OFF  
Throttle . . . . . close  
Propeller . . . . . feather  
Mixture . . . . . idle cut-off  
Heater . . . . . OFF  
Defroster . . . . . OFF

If terrain permits land immediately, if fire  
continues.

**FUEL MANAGEMENT DURING SINGLE  
ENGINE OPERATION**

**CRUISING**

When using fuel from tank on the same side as the  
operating engine:

Fuel selector operating engine . . . . . ON  
Fuel selector inop. engine . . . . . OFF  
Auxiliary fuel pumps . . . . . OFF

When using fuel from tank on the side opposite the  
operating engine:

Fuel selector operating engine . . . . . CROSSFEED  
Fuel selector inop. engine . . . . . OFF  
Auxiliary fuel pumps . . . . . OFF

Use crossfeed in level flight only.

**NOTE**

Do not crossfeed with full fuel on same  
side as operating engine since vapor  
return fuel flow will be lost through the  
vent system.

**LANDING**

Fuel selector operating engine . . . . . ON  
Fuel selector inop. engine . . . . . OFF

**ENGINE DRIVEN FUEL PUMP FAILURE**

- Throttle . . . . . retard
- Auxiliary fuel pump . . . . . unlatch,  
on HI
- Throttle . . . . . reset (75%  
power or below)

**CAUTIONS**

If normal engine operation and fuel flow is not immediately re-established, the auxiliary fuel pump should be turned off. The lack of a fuel flow indication while on the HI auxiliary fuel pump position could indicate a leak in the fuel system, or fuel exhaustion.

DO NOT actuate the auxiliary fuel pumps unless vapor suppression is required (LO position) or the engine driven fuel pump fails (HI position). The auxiliary pumps have no standby function. Actuation of the HI switch position when the engines are operating, normally may cause engine roughness and/or power loss.

**LANDING GEAR UNSAFE WARNING**

Red light indicates gear intransit.  
Recycle gear if indication continues.  
Light will illuminate when gear horn sounds at low throttle settings.

**MANUAL EXTENSION OF LANDING GEAR**

- Check following before extending gear manually:
- Circuit breakers . . . . . check
  - Master switch . . . . . ON
  - Alternators . . . . . check
  - Navigation lights . . . . . OFF  
(daytime)

To extend, reposition clip downward clear of knob and proceed as follows:

- Airspeed . . . . . reduce (85 KIAS max.)
- Gear selector . . . . . GEAR DOWN  
LOCKED position
- Emerg. gear extend knob . . . . . pull
- Indicator lights . . . . . 3 green
- Leave emergency gear extension knob out.

**ENGINE FAILURE IN ICING CONDITIONS**

- Select alternate air and attempt restart.
- If unable to restart engine:
- Inop. prop . . . . . feather
- Airspeed . . . . . at or above 89 KIAS
- Descend if necessary to maintain airspeed.
- Electrical load . . . . . reduce
- Avoid further icing conditions if possible.
- Land as soon as practical.
- Maintain at least 89 KIAS on final.
- Do not extend gear or lower flaps until certain of making field.
- Flaps . . . . . 25°

**ALTERNATOR FAILURE IN ICING CONDITIONS**

- Overvoltage relay . . . . . reset
- Circuit breakers . . . . . check and reset

If unable to restore alternator:

- Avionics . . . . . all off except  
Nav Com and Transp.
- Electric Windshield . . . . . OFF to  
maintain 65A load

If icing continues terminate flight as soon as practical.

Prior to landing:

- Electric windshield . . . . . ON if necessary
- Gear may require free fall extension.

**ENGINE FAILURE WITH REAR CABIN AND CARGO DOORS REMOVED**

- S.E. min. control speed of 67 KIAS for this configuration.
- If airspeed is below 67 KIAS reduce power on operating engine to maintain control.

**ELECTRICAL FAILURES**

ALT annunciator light illuminated.

Ammeters . . . . . observe to  
determine inop. alt.

If both ammeters show zero output, reduce electrical load to a minimum.

Turn OFF both alt. switches; then turn them ON momentarily one at a time while observing ammeters.

Determine alt. showing LEAST (but not zero) amperes and turn its switch on.

Electrical loads . . . . . re-establish up to 60A

If one ammeter shows zero output, cycle its switch off, then on.

If power is not restored check circuit breakers and reset once if required.

If alternator remains inoperative, reduce electrical loads and continue flight.

**WARNING**

Compass error may exceed 10° with both alternators inoperative.

**GYRO PRESSURE FAILURES**

Pressure below 4.5 in Hg.

RPM . . . . . increase to 2575

Altitude . . . . . descend to maintain  
4.5 in Hg

Use electric turn indicator to monitor Directional Indicator and Attitude Indicator performance.

**COMBUSTION HEATER OVERHEAT**

Unit will automatically cut-off.

Do not attempt to restart.

**SPINS**

Throttles . . . . . retard to idle

Rudder . . . . . full opposite to  
direction of spin

Control wheel . . . . . release back pressure

Control wheel . . . . . full forward if  
nose does not drop

Ailerons . . . . . neutral

Rudder . . . . . neutralize when  
rotation stops

Control wheel . . . . . smooth back pressure  
to recover from dive

**EMERGENCY DESCENT**

Throttles . . . . . closed

Propellers . . . . . full forward

Mixture . . . . . as required  
for smooth operation

Landing gear . . . . . extend

Airspeed . . . . . 129 KIAS

**THIS PAGE INTENTIONALLY LEFT BLANK**



### 3.5 AMPLIFIED EMERGENCY PROCEDURES (GENERAL)

The following paragraphs are presented to supply additional information for the purpose of providing the pilot with a more complete understanding of the recommended course of action and probable cause of an emergency situation.

### 3.7 ENGINE INOPERATIVE PROCEDURES

#### DETECTING A DEAD ENGINE

A loss of thrust will be noted and with coordinated controls, the nose of the aircraft will yaw in the direction of the dead engine.

#### ENGINE SECURING PROCEDURE (FEATHERING PROCEDURE)

The propellers can be feathered only while the engine is rotating above 800 RPM. Loss of centrifugal force due to slowing RPM will actuate a stop pin that keeps the propeller from feathering each time the engine is stopped on the ground. Single engine performance will decrease if the propeller of the inoperative engine is not feathered.

#### NOTE

If circumstances permit, in the event of an actual engine failure, the pilot may elect to attempt to restore power prior to feathering.

If circumstances permit an attempt to restore power prior to feathering, adjust the mixture control as required, move the fuel selector control to Crossfeed and select either L (left) or R (right) magneto to check magneto grounding. Move the alternate air control to ON and unlatch the auxiliary fuel pump switch and turn it to the HI position. If power is not immediately restored turn off the auxiliary fuel pump.

Keep in mind that the minimum single engine control speed is 66 KIAS and the best single engine rate of climb speed is 89 KIAS when beginning the feathering procedure.

To feather a propeller, maintain direction and an airspeed above 76 KIAS. Move the mixture and propeller controls forward. The throttle controls should be moved forward while monitoring the manifold pressure gauge to ensure that the manifold pressure does not exceed 40 inches of Hg. Retract the flaps and landing gear and identify the inoperative engine. The airplane will yaw in the direction of the dead engine. Retard the throttle of the suspect engine to verify loss of power. The mixture control of the inoperative engine should be moved to idle cut-off position and the propeller control of the inoperative engine should be moved to the feather position.

Trim the aircraft as required and maintain a 5° bank toward the operating engine. The auxiliary fuel pumps should be off except in the case of an engine driven fuel pump failure. Turn OFF the magnetos and close the cowl flaps on the inoperative engine. Cowl flaps should be used as necessary on the operative engine. The alternator of the inoperative engine should be turned OFF and the electrical load reduced to prevent depletion of the battery. Move the fuel selector control for the inoperative engine to the OFF position. If necessary, consider the use of crossfeed (refer to Fuel Management During Single Engine Operation, paragraph 3.11).

**NOTE**

When an engine is feathered the alternator, gyro air, and oil annunciator warning lights will remain illuminated.

**ENGINE FAILURE DURING TAKEOFF (Below 85 KIAS)**

The single engine minimum control speed for this airplane is 66 KIAS under standard conditions.

If engine failure occurs during takeoff ground roll or 85 KIAS has not been attained, CLOSE both throttles immediately, land if airborne, and stop straight ahead. If inadequate runway remains to stop, close the throttles, land if airborne and apply maximum braking. The master switch and fuel selectors should be turned OFF. Continue path straight ahead turning to avoid obstacles as necessary.

**ENGINE FAILURE DURING TAKEOFF (85 KIAS or above)**

If engine failure during takeoff ground roll or after lift-off with the gear still down and 85 KIAS has been attained the course of action to be taken will depend on the runway remaining. If adequate runway remains, CLOSE both throttles immediately, land if airborne and stop straight ahead. If the runway remaining is inadequate for stopping, the pilot must decide whether to abort the takeoff or to continue. The decision must be based on the pilot's judgment considering loading, density altitude, obstructions, the weather, and the pilot's competence. If the decision is made to continue the takeoff, maintain heading and airspeed. Feather the inoperative engine and when climb is established RETRACT the landing gear. (Refer to Engine Securing Procedures, paragraph 3.7).

During a short field takeoff with 25° flaps, the airplane is momentarily below V<sub>mc</sub>. In the event that an engine failure should occur while the airplane is below V<sub>mc</sub>, it is mandatory that the throttle on the operating engine be retarded and the nose lowered immediately to maintain control of the airplane.

**ENGINE FAILURE DURING CLIMB**

The single engine minimum control speed for this airplane is 66 KIAS under standard conditions.

If an engine failure occurs when airspeed is below 66 KIAS reduce the power on the operating engine as required to maintain directional control. The nose of the airplane should be lowered to accelerate toward the best single engine rate of climb speed of 89 KIAS. The next step is to feather the inoperative engine (refer to Engine Securing Procedure, paragraph 3.7).

If engine failure occurs when an airspeed of 66 KIAS has been attained, maintain directional control and adjust airspeed toward the best single engine rate of climb speed of 89 KIAS. The inoperative engine should now be feathered by following the Engine Securing Procedure provided by paragraph 3.7.

#### ENGINE FAILURE DURING FLIGHT (Below 66 KIAS)

Should an engine fail during flight at an airspeed below 66 KIAS, apply rudder towards the operative engine to maintain directional control. The throttles should be retarded to stop the yaw force produced by the asymmetrical thrust. Lower the nose of the aircraft to accelerate above 66 KIAS and increase the power on the operative engine as the airspeed exceeds 66 KIAS.

After an airspeed above 76 KIAS has been established, an engine restart attempt may be made if altitude permits. If the restart has failed, or altitude does not permit, the engine should be secured. Move the propeller control of the inoperative engine to FEATHER and complete the "Engine Securing Procedure." Adjust the trim to 5° bank toward the operating engine. The cowl flap on the operative engine should be adjusted as required to maintain engine temperature within allowable limits.

#### ENGINE FAILURE DURING FLIGHT (Above 66 KIAS)

If an engine fails at an airspeed above 66 KIAS during flight, begin corrective response by identifying the inoperative engine. The operative engine should be adjusted as required after the loss of power has been verified. Once the inoperative engine has been identified and the operating engine adjusted properly, an engine restart may be attempted if altitude permits and the airspeed is maintained above 76 KIAS.

Prior to securing the inoperative engine, check to make sure the fuel flow to the engine is sufficient. If the fuel flow is deficient, turn ON the auxiliary fuel pump to the inoperative engine. Check the fuel quantity on the inoperative engine side for a sufficient supply, switch the alternate air "ON" and vary the mixture control position. Check the oil pressure and oil temperature and insure that the magneto switches are ON.

If the engine fails to start it should be secured using the Engine Securing Procedure.

After the inoperative engine has been secured, the operative engine can be adjusted. Power should be maintained as required and the mixture control should be adjusted for power. Check the fuel supply and turn ON the auxiliary fuel pump if necessary. The cowl flaps on the operative engine should be adjusted as required to maintain engine temperatures within allowable limits. Trim 5° bank toward the operating engine. The electrical load should be decreased to a required minimum. Land as soon as practical at the nearest suitable airport.

#### SINGLE ENGINE LANDING

Complete the Engine Securing Procedure (paragraph 3.7). The landing gear should not be extended and the wing flaps should not be lowered until certain of making the field.

Maintain additional altitude and speed during approach, keeping in mind that landing should be made right the first time and that a go-around should be avoided if at all possible.

A final approach speed of 91 KIAS and the use of 25° rather than full wing flaps will place the airplane in the best configuration for a go-around should this be necessary. **UNDER SOME CONDITIONS OF LOADING AND DENSITY ALTITUDE A GO-AROUND MAY BE IMPOSSIBLE, AND IN ANY EVENT THE SUDDEN APPLICATION OF POWER DURING SINGLE ENGINE OPERATION MAKES CONTROL OF THE AIRPLANE MORE DIFFICULT.**

### **SINGLE ENGINE GO-AROUND**

**A SINGLE ENGINE GO-AROUND SHOULD BE AVOIDED IF AT ALL POSSIBLE.**

To execute a single engine go-around, advance the mixture and propeller levers forward. The throttle should be advanced slowly to 40 inches of manifold pressure. Retract the flaps and landing gear. Maintain airspeed at the best single engine rate of climb speed of 89 KIAS. Set the trim and cowl flaps as required.

### **AIR START (UNFEATHERING PROCEDURE)**

Move the fuel selector for the inoperative engine to the ON position and check to make sure the auxiliary fuel pump for that engine is OFF. Open the throttle 1/4 inch and push the propeller control forward to the cruise RPM position. The mixture should be set RICH. Turn ON the magneto switches and engage the starter until the propeller windmills. The throttle should be set at reduced power until the engine is warm. If the engine does not start, prime as necessary. The alternator switch should then be turned ON.

## **3.9 ENGINE FIRE**

### **IN-FLIGHT**

The possibility of an engine fire in flight is extremely remote. The procedure given below is general and pilot judgment should be the deciding factor for action in such an emergency.

If an engine fire occurs in flight, place the fuel selector of the affected engine in the OFF position and close its throttle. Feather the propeller on the faulty engine. Move the mixture control to idle cut-off. The heater and defroster (in all cases of fire) should be OFF. A landing should be made if terrain permits.

### **ON THE GROUND**

The first attempt to extinguish the fire is to try to draw the fire back into the engine. If the engine has not started move the mixture control to idle cut-off and open the throttle. Begin to crank the engine with the starter in an attempt to pull the fire into the engine.

If the engine has already started and is running, continue operating to try to pull the fire into the engine.

In either case (above), if the fire continues longer than a few seconds the fire should be extinguished by the best available external means.

If an external fire extinguishing method is to be applied move the fuel selector valves to OFF and the mixture to idle cut-off.

---

### **3.11 FUEL MANAGEMENT DURING SINGLE ENGINE OPERATION**

A crossfeed is provided to increase range during single engine operation. Use crossfeed in level flight only.

#### **CRUISING**

When using fuel from the fuel tank on the same side as the operating engine the fuel selector of the operating engine should be ON and the fuel selector for the inoperative engine should be OFF. The auxiliary fuel pumps should be OFF except in the case of an engine driven fuel pump failure. If an engine driven fuel pump has failed the auxiliary fuel pump on the operating engine side must be ON.

Increased range is available by using fuel from the tank on the opposite side of the operating engine. For this configuration the fuel selector of the operating engine should be on X-FEED (crossfeed) and the fuel selector of the inoperative engine should be OFF. The auxiliary fuel pumps should be OFF.

#### **NOTE**

A vapor return line from each engine will return a percentage of fuel back to the tank on the same side as that engine. Therefore, a minimum of 30 minutes of fuel should be used from this tank before selecting crossfeed. If the tank gauge approaches "FULL," go back to that tank and operate for 30 minutes to bring the fuel level down before returning to crossfeed or fuel may be pumped overboard through the fuel vent.

#### **LANDING**

During the landing sequence the fuel selector of the operating engine must be ON and the fuel selector of the inoperative engine OFF. The auxiliary fuel pump of the operating engine should be OFF except in the case of an engine driven fuel pump failure.

### **3.13 ENGINE DRIVEN FUEL PUMP FAILURE**

Should a malfunction of the engine driven fuel pump occur, the auxiliary fuel pump system can supply sufficient fuel pressure for engine power up to approximately 75%. Any combination of RPM and Manifold Pressure defined on the Power Setting Table may be used, but leaning may be required for smooth operation at altitudes above 15,000 feet or for RPM's below 2300. Normal cruise, descent and approach procedures should be used.

Loss of fuel pressure and engine power can be an indication of failure of the engine driven fuel pump. Should these occur and engine driven fuel pump failure is suspected, retard the throttle and unlatch the auxiliary fuel pump and select the HI position. The throttle can then be reset at 75% power or below.

#### **CAUTION**

If normal engine operation and fuel flow is not immediately re-established, the auxiliary fuel pump should be turned off. The lack of a fuel flow indication while on the HI auxiliary fuel pump position could indicate a leak in the fuel system, or fuel exhaustion.

DO NOT actuate the auxiliary fuel pumps unless vapor suppression is required (LO position) or the engine driven fuel pump fails (HI position). The auxiliary pumps have no standby function. Actuation of the HI switch position when the engines are operating normally may cause engine roughness and/or power loss.

### **3.15 LANDING GEAR UNSAFE WARNINGS**

The red landing gear light will illuminate when the landing gear is in transition between the full up position and the down and locked position. The pilot should recycle the landing gear if continued illumination of the light occurs. Additionally, the light will illuminate when the gear warning horn sounds. The gear warning horn will sound at low throttle settings if the gear is not down and locked.

### **3.17 MANUAL EXTENSION OF THE LANDING GEAR**

Several items should be checked prior to extending the landing gear manually. Check for popped circuit breakers and ensure the master switch is ON. Now check the alternators. If it is daytime, turn OFF the navigation lights.

To execute a manual extension of the landing gear, begin by repositioning the clip covering the emergency disengage control downward, clear of the knob. Power should be reduced to maintain airspeed below 85 KIAS. Place the landing gear selector switch in the GEAR DOWN LOCKED position and pull the emergency gear extension knob. Check for 3 green indicator lights.

#### **WARNING**

If the emergency gear extension knob has been pulled out to lower the gear due to a gear system malfunction, leave the control in its extended position until the airplane has been put on jacks to check the proper function of the landing gears hydraulic and electrical systems.

### 3.19 GEAR-UP EMERGENCY LANDING

An approach should be made with power at a normal airspeed with the flaps up. The flaps are left up to reduce wing and flap damage. Close the throttles just before touchdown. Turn OFF the master and ignition switches and move the fuel selector valve controls to OFF. Contact to the surface should be made at a minimum airspeed.

### 3.21 ENGINE FAILURE IN ICING CONDITIONS

If engine failure occurs during icing flight select ALTERNATE AIR and attempt to restart the engine. If the engine restart procedure fails, feather the inoperative propeller (refer to Engine Securing Procedure, paragraph 3.7). An airspeed at or above 89 KIAS must be maintained. It may be necessary to descend to maintain this airspeed. Reduce the electrical loads (refer to Alternator Failure in Icing Conditions, paragraph 3.23, for load reduction). Further icing conditions should be avoided if possible and a landing made as soon as practical.

Maintain an airspeed of at least 89 KIAS during final approach. Do not extend the landing gear or lower the wing flaps until certain of making the field. Use 25° flaps rather than full flaps for landing.

### 3.23 ALTERNATOR FAILURE IN ICING CONDITIONS

If an alternator fails during flight in icing conditions, an attempt should be made to reset the alternator overvoltage relay by cycling the corresponding alternator switch OFF and then ON. Check the circuit breakers and, if possible, reset any that have popped.

If these attempts to restore the alternator have failed, turn off all avionics except one NAV COM and TRANSPONDER. Turn off the electric windshield to maintain a load less than 65 amperes. If icing conditions continue terminate flight as soon as practical.

Prior to landing the electric windshield may be turned on if necessary. If the battery has been depleted the gear may require free-fall extension and the green gear lights may not illuminate.

### 3.25 ENGINE FAILURE WITH REAR CABIN AND CARGO DOORS REMOVED

The minimum single engine control speed for this configuration is 67 KIAS. If engine failure occurs at an airspeed below 67 KIAS, reduce power as necessary on the operating engine and apply rudder to maintain directional control.

### **3.27 ELECTRICAL FAILURES**

If an ALT annunciator light illuminates observe the ammeters to determine which alternator is inoperative. If both ammeters show zero output, reduce electrical loads to the minimum. Turn OFF both alternator switches and then turn them momentarily ON one at a time while observing the ammeters. The alternator showing the LEAST (but not zero) current should be turned ON. The other alternator should be left OFF. Electrical loads may be reinstated as required to a maximum of 60 amperes.

If one ammeter shows zero output, cycle its switch OFF and then ON. If this fails to restore output check the circuit breakers. The breakers may be reset once if required. If the alternator remains inoperative reduce electrical loads if necessary and continue the flight.

Corrective maintenance actions should be performed prior to further flights.

#### **WARNING**

Compass error may exceed 10° with both alternators inoperative.

#### **NOTE**

The markings on the ammeters (loadmeters) require mental interpolations to estimate the ampere values noted. Operating the alternators at less than 65 amperes will assure that the battery will not be depleted.

### **3.29 GYRO PRESSURE FAILURES**

A malfunction of the instrument pressure system will be indicated by a reduction of the pressure reading on the gauge. A red button annunciator will show in case of a feathered engine or pressure pump failure.

In the event of a pressure system malfunction, (pressure lower than 4.5 inches of mercury) increase engine RPM to 2575. Descend to an altitude at which 4.5 inches of mercury pressure can be maintained, if possible. The electric turn indicator should be used to monitor the performance of the directional and attitude indicators.

### **3.31 COMBUSTION HEATER OVERHEAT**

In the event of an overheat condition, the fuel, air and ignition to the heater is automatically cut off. Do not attempt to restart the heater until it has been inspected and the cause of the malfunction has been determined and corrected.



### 3.33 SPIN RECOVERY

Intentional spins are prohibited in this airplane. In the event a spin is encountered unintentionally, immediate recovery actions must be taken.

To recover from an unintentional spin, immediately retard the throttles to the idle position. Apply full rudder opposite the direction of the spin rotation. Let up all back pressure on the control wheel. If the nose does not drop, immediately push the control wheel full forward. Keep the ailerons neutral. Maintain the controls in these positions until spin rotation stops, then neutralize the rudder. Recovery from the resultant dive should be with smooth back pressure on the control wheel. No abrupt control movement should be used during recovery from the dive, as the positive limit maneuvering load factor may be exceeded.

### 3.35 EMERGENCY DESCENT

A malfunction of the oxygen system requires an immediate descent to an altitude at or below 12,500 feet.

#### NOTE

Time of useful consciousness at 25,000 feet is approximately three minutes.

In the event an emergency descent becomes necessary, CLOSE the throttles and move the propeller controls full FORWARD. Adjust the mixture control as necessary to attain smooth operation. Extend the landing gear at 129 KIAS and maintain this airspeed.

### 3.37 DOOR OPEN ON TAKEOFF

If either the main or rear cabin door is inadvertently left open or partially open on takeoff, fly the airplane in a normal manner and return for a landing to close the door on the ground. If a landing cannot be made it may be possible to close a door in flight.

Maintain an airspeed between 85 and 94 KIAS and open the storm window. Pull the door closed, making certain the upper latch is properly positioned. Close the upper latch. It may be necessary to pull in on the upper portion of the door while the latch is being closed.

It is necessary to have someone in the airplane in addition to the pilot to carry out this procedure. If the door, either main or rear, cannot be closed in flight, it is possible to continue safely for an extended period. In this case, the airspeed should be kept below 107 KIAS and above 85 KIAS to prevent buffeting as a result of the open door.

### 3.39 DUAL ALTERNATOR FAILURE

In the event of a failure of both alternators, immediate action should be taken to reduce the overall electrical load on the system. Assuming the aircraft's battery and electrical system are in normal operating condition, the following approximate durations are probable.

Day VFR with (1) each Transponder, COMM, NAV, DME and ADF = 115 minutes. Night IFR with (1) each Transponder, COMM, NAV, DME, ADF and Instrument Panel and position lights = 35 minutes.

**3.41 WING-TAIL DEICER PANEL LIGHT**

If light is illuminated more than 20 seconds pull surface deice circuit breaker.

**TABLE OF CONTENTS**  
**SECTION 4**  
**NORMAL PROCEDURES**

Paragraph No.		Page No.
4.1	General .....	4-1
4.3	Airspeeds For Safe Operations .....	4-1
4.5	Normal Procedures Checklist .....	4-3
	Preparation .....	4-3
	Preflight Check .....	4-3
	Before Starting Engines .....	4-4
	Starting Engines .....	4-4
	Starting Engines In Cold Weather .....	4-5
	Warm-Up .....	4-5
	Taxiing .....	4-5
	Before Takeoff - Ground Check .....	4-6
	Takeoff .....	4-6
	Takeoff Climb .....	4-7
	Cruise Climb .....	4-7
	Cruising .....	4-7
	Descent .....	4-7
	Approach and Landing .....	4-7
	Go-Around .....	4-7
	After Landing .....	4-7
	Shutdown .....	4-7
4.7	Amplified Normal Procedures (General) .....	4-9
4.9	Preparation .....	4-9
4.11	Preflight Check .....	4-9
4.13	Before Starting Engines .....	4-10
4.15	Starting Engines (Standard Primer System) .....	4-11
4.16	Starting Engines (Optional Primer System) .....	4-11
4.17	Starting Engines When Flooded .....	4-12
4.19	Starting Engines In Cold Weather (Standard Primer System) .....	4-12
4.21	Starting Engines With External Power .....	4-13
4.23	Taxiing .....	4-14
4.25	Before Takeoff - Ground Check .....	4-14
4.27	Takeoff .....	4-15
4.29	Climb .....	4-17
4.31	Cruising .....	4-18
4.33	Descent .....	4-19
4.35	Approach and Landing .....	4-20
4.37	Go-Around .....	4-21

**TABLE OF CONTENTS (cont)**

**SECTION 4 (cont)**

Paragraph No.		Page No.
4.39	After Landing .....	4-21
4.41	Shutdown .....	4-22
4.43	Mooring .....	4-22
4.45	Turbulent Air Operation .....	4-22
4.47	Flight Into Known Icing Conditions .....	4-23
4.49	Flight With Rear Cabin and Cargo Doors Removed .....	4-25
4.50	VSSE - Intentional One Engine Inoperative Speed .....	4-25
4.51	VMC - Minimum Single Engine Control Speed .....	4-26
4.53	Stalls .....	4-26

**SECTION 4**  
**NORMAL PROCEDURES**

**NO CHANGES EXCEPT:**

**4.51  $V_{MCA}$  - MINIMUM SINGLE-ENGINE CONTROL SPEED**

$V_{MCA}$  is the airspeed below which a twin-engine aircraft cannot be controlled in flight with one engine operating at takeoff power and the other engine windmilling and a five degree bank into the operating engine.  $V_{MCA}$  for the Seneca II has been determined to be 61 KIAS.

**4.53 STALLS**

The loss of altitude during a power off stall with the gear and flaps retracted may be as much as 300 feet. The loss of altitude with the gear down and 40° of flaps may also be as much as 300 feet.

A power on stall may result in as much as 150 feet of altitude loss.

SECTION 4  
NORMAL PROCEDURES

10 - 100000000000

SECTION 4  
NORMAL PROCEDURES

The following information is provided for your reference. It is not intended to be used as a substitute for the actual procedures. The information is provided for your reference only. It is not intended to be used as a substitute for the actual procedures.

10 - 100000000000

The following information is provided for your reference. It is not intended to be used as a substitute for the actual procedures. The information is provided for your reference only. It is not intended to be used as a substitute for the actual procedures.

The following information is provided for your reference. It is not intended to be used as a substitute for the actual procedures. The information is provided for your reference only. It is not intended to be used as a substitute for the actual procedures.

## SECTION 4 NORMAL PROCEDURES

### 4.1 GENERAL

This section describes the recommended procedures for the conduct of normal operations for the Seneca II. All of the required (FAA regulations) procedures and those necessary for the safe operation of the airplane as determined by the operating and design features of the airplane are presented.

Normal procedures associated with those optional systems and equipment which require handbook supplements are provided by Section 9 (Supplements).

These procedures are provided to present a source of reference and review and to supply information on procedures which are not the same for all aircraft. Pilots should familiarize themselves with the procedures given in this section in order to become proficient in the normal operations of the airplane.

The first portion of this section consists of a short form check list which supplies an action sequence for normal operations with little emphasis on the operation of the systems.

The remainder of the section is devoted to amplified normal procedures which provide detailed information and explanations of the procedures and how to perform them. This portion of the section is not intended for use as an in-flight reference due to the lengthy explanations. The short form check list should be used for this purpose.

### 4.3 AIRSPEEDS FOR SAFE OPERATIONS

The following airspeeds are those which are significant to the safe operation of the airplane. These figures are for standard airplanes flown at gross weight under standard conditions at sea level.

Performance for a specific airplane may vary from published figures depending upon the equipment installed, the condition of the engine, airplane and equipment, atmospheric conditions and piloting technique.

(a) Best Rate of Climb Speed	89 KIAS
(b) Best Angle of Climb Speed	76 KIAS
(c) Turbulent Air Operating Speed (See Subsection 2.3)	136 KIAS
(d) Maximum Flap Speed	107 KIAS
(e) Landing Final Approach Speed (Flaps 40°)	79 KIAS
(f) Intentional One-Engine Inoperative Speed	76 KIAS
(g) Maximum Demonstrated Crosswind Velocity	17 KTS

**THIS PAGE INTENTIONALLY LEFT BLANK**



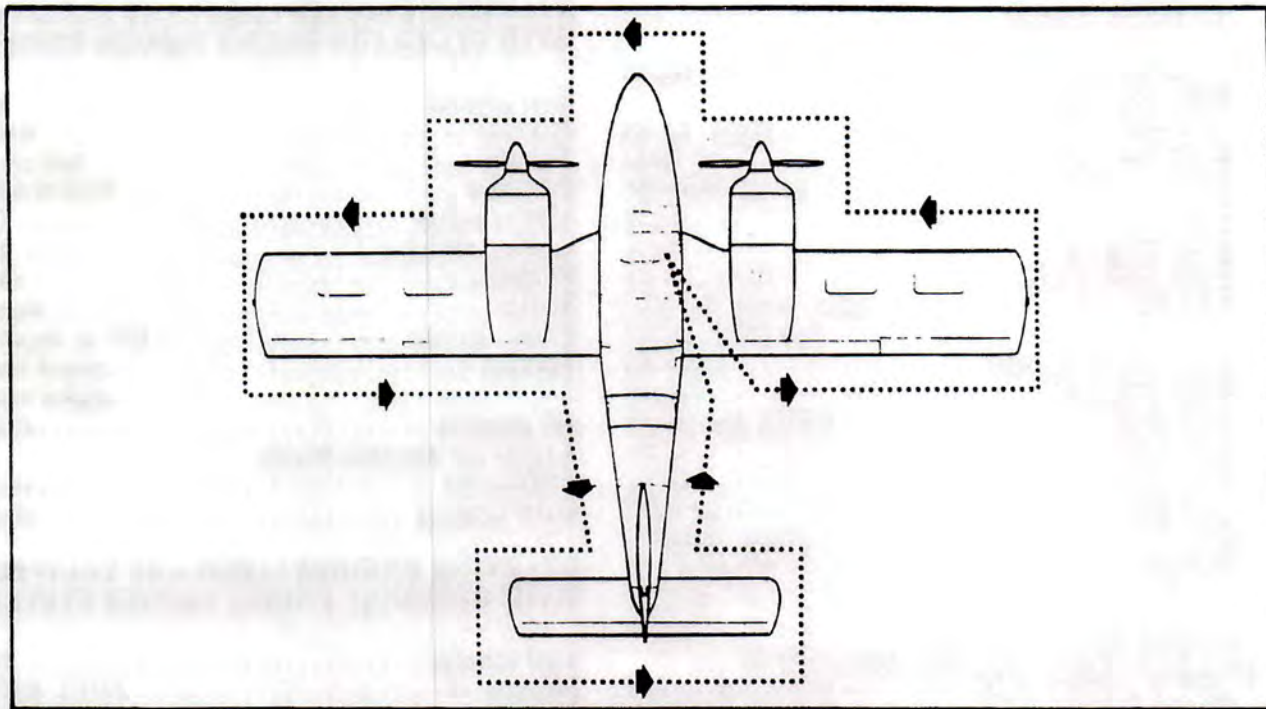

WALK AROUND

Figure 4-1

4.5 NORMAL PROCEDURES CHECK LIST

PREPARATION

- Airplane status . . . . . airworthy,  
papers on board
- Weather . . . . . suitable
- Baggage . . . . . weighed, stowed,  
tied
- Weight and C.G. . . . . within limits
- Navigation . . . . . planned
- Charts and navigation  
equipment . . . . . on board
- Performance and range . . . . . computed  
and safe

PREFLIGHT CHECK

INSIDE CABIN

- Landing gear control . . . . . DOWN position
- Avionics . . . . . OFF
- Master switch . . . . . ON
- Landing gear lights . . . . . 3 GREEN,  
no red
- Fuel quantity . . . . . adequate plus  
reserve
- Cowl flaps . . . . . OPEN
- Master switch . . . . . OFF
- Ignition switches . . . . . OFF
- Mixture controls . . . . . idle cut-off
- Trim indicators . . . . . neutral
- Flaps . . . . . check operation
- Controls . . . . . free
- Pitot and static systems . . . . . drain
- Empty seats . . . . . fasten belts
- Crossfeed drains . . . . . drain

**OUTSIDE CABIN**

Crossfeed drains ..... closed  
 Right wing, aileron  
     and flap ..... check, no ice  
 Right main gear ..... no leaks  
 Strut ..... proper inflation  
 Tire ..... check  
 Right wing tip ..... check  
 Right leading edge ..... check, no ice  
 Fuel cap ..... open, check quantity  
   and color, secure  
 Right engine nacelle ..... check oil  
 Right propeller ..... check  
 Cowl flaps ..... OPEN and secure  
 Fuel drains ..... drain  
 Nose section ..... check  
 Nose gear ..... no leaks  
 Strut ..... proper inflation  
 Tow bar ..... removed and  
   stowed  
 Landing light ..... check  
 Forward baggage door (key removable in  
     locked position only) ..... secure and locked  
 Windshield ..... clean  
 Left wing, engine nacelle  
     and landing gear ..... check as on  
   right side  
 Pitot tube ..... clear, checked  
 Stall warning vanes ..... check  
 Rear door ..... latched  
 Left static vent ..... clear  
 Dorsal fin air scoop ..... clear  
 Empennage ..... check, no ice  
 Stabilator ..... free  
 Right static vent ..... clear  
 Antennas ..... check  
 Navigation and landing lights ..... check

**BEFORE STARTING ENGINES**

Seats ..... adjusted  
 Seat belts and harness ..... fasten/adjust  
   check inertia reel  
 Parking brake ..... set  
 Circuit breakers ..... in  
 Radios ..... OFF  
 Cowl flaps ..... OPEN  
 Alternate air ..... OFF  
 Alternators ..... ON

**REPORT: VB-850  
4-4**

**STARTING ENGINES (AIRPLANE EQUIPPED  
WITH STANDARD ENGINE PRIMER SYSTEM)**

Fuel selector ..... ON  
 Mixture ..... RICH  
 Throttle ..... half travel  
 Propeller ..... FORWARD  
 Master switch ..... ON  
 Ignition switches ..... ON  
 Propeller ..... clear  
 Starter ..... engage  
 Primer button ..... ON as required  
   retard when  
   engine starts  
 Oil pressure ..... check  
 Repeat for opposite engine  
 Alternators ..... check  
 Gyro pressure ..... check

**STARTING ENGINES (AIRPLANE EQUIPPED  
WITH OPTIONAL ENGINE PRIMER SYSTEM)**

Fuel selector ..... ON  
 Mixture ..... FULL RICH  
 Throttle ..... FULL FORWARD  
 Prop control ..... FULL FORWARD  
 Master switch ..... ON  
 Ignition switch (mag) ..... ON  
 Auxiliary fuel pump ..... OFF  
 Primer ..... ON  
   See Figure 4-3  
   for Priming Time  
 Throttle ..... CLOSE  
 Starter ..... engage  
 At temperatures below +20° F continue priming  
 while cranking until engine starts.

When engine starts & accelerates thru 500 RPM:  
 Starter ..... release  
 Throttle ..... advance slowly  
   to obtain 1000 RPM  
 Primer ..... release  
 Auxiliary fuel pump ..... low only as  
   necessary to obtain  
   smooth engine operation  
   (1-3 minutes will be  
   required when temp. is  
   below 20° F)  
 Oil pressure ..... check  
 Repeat for opposite engine.

**ISSUED: AUGUST 23, 1976  
REVISED: NOVEMBER 30, 1987**

Alternators . . . . . check  
Gyro pressure . . . . . check

**NOTE**

When starting at ambient temperatures +20°F and below, operate first engine started with alternator ON (at max charging rate not to exceed 1500 RPM) for 5 minutes minimum before initiating start on second engine.

**STARTING ENGINES WHEN FLOODED**

Mixture . . . . . idle cut-off  
Throttle . . . . . full FORWARD  
Propeller . . . . . FORWARD  
Master switch . . . . . ON  
Ignition switches . . . . . ON  
Auxiliary fuel pump . . . . . OFF  
Propeller . . . . . clear  
Starter . . . . . engage

When engine fires:  
Throttle . . . . . retard  
Mixture . . . . . advance slowly

**STARTING ENGINES IN COLD WEATHER  
(AIRPLANE EQUIPPED WITH STANDARD  
ENGINE PRIMER SYSTEM)**

Props . . . . . turn through  
by hand (3 times)  
Fuel selector . . . . . ON  
Mixture . . . . . full RICH  
Throttle . . . . . full FORWARD  
Prop control . . . . . full FORWARD  
Master switch . . . . . ON  
Ignition switch (mag) . . . . . ON  
Auxiliary fuel pump . . . . . ON LOW boost  
Starter . . . . . engage  
Primer . . . . . On for 3 sec.  
Throttle . . . . . full FORWARD  
to full AFT  
Primer . . . . . ON 3 sec.,  
then OFF 3 sec.,  
then ON 3 sec.

When engine fires:  
Starter . . . . . leave engaged  
Primer button . . . . . tap until  
rhythmic firing  
Starter . . . . . release  
Throttle . . . . . half travel  
Oil pressure . . . . . check

If engine begins to falter:  
Primer button . . . . . tap  
Throttle . . . . . 1000 RPM

Auxiliary fuel pump . . . . . OFF after  
start complete

**STARTING WITH EXTERNAL POWER SOURCE**

Master switch . . . . . OFF  
All electrical equipment . . . . . OFF  
Terminals . . . . . connect  
External power plug . . . . . insert in  
fuselage

Proceed with normal start  
Throttles . . . . . lowest possible  
RPM  
External power plug . . . . . disconnect from  
fuselage  
Master switch . . . . . ON-check ammeter  
Oil pressure . . . . . check

**WARM-UP**

Throttles . . . . . 1000 to 1200 RPM

**TAXIING**

Chocks . . . . . removed  
Taxi area . . . . . clear  
Throttle . . . . . apply slowly  
Brakes . . . . . check  
Steering . . . . . check  
Instruments . . . . . check  
Heater and defroster . . . . . check  
Fuel selector . . . . . ON, check  
crossfeed  
Autopilot . . . . . OFF

**BEFORE TAKEOFF - GROUND CHECK**

Parking brake . . . . . ON  
 Mixture controls . . . . . FORWARD  
 Prop. controls . . . . . FORWARD  
 Throttle control . . . . . 1000 RPM  
 Manifold pressure lines . . . . . drain  
 Prop. controls . . . . . check feathering,  
 300 RPM max. drop  
 Throttle controls . . . . . 1900 RPM  
 Prop. controls . . . . . check governor  
 Prop. controls . . . . . full FORWARD  
 Alternate air . . . . . ON then OFF  
 Magnetos . . . . . check, max. drop  
 150 RPM, max. diff.  
 drop 50 RPM  
 Alternator output . . . . . check  
 Gyro pressure gauge . . . . . 4.5 to 5.2 in. Hg.  
 Throttles . . . . . 800-1000 RPM  
 Fuel selectors . . . . . ON  
 Alternators . . . . . ON  
 Engine gauges . . . . . in the green  
 Annunciator panel . . . . . press-to-test  
 Altimeter . . . . . set  
 Attitude indicator . . . . . set  
 D.G. . . . . set  
 Clock . . . . . wound and set  
 Mixtures . . . . . set  
 Propellers . . . . . set in forward  
 position  
 Quadrant friction . . . . . adjusted  
 Alternate air . . . . . OFF  
 Cowl flaps . . . . . set  
 Seat backs . . . . . erect  
 Wing flaps . . . . . set  
 Trim . . . . . set  
 Seat belts and harness . . . . . fasten/adjust  
 Empty seats . . . . . seat belts fastened  
 Controls . . . . . free, full travel  
 Doors . . . . . latched  
 Auxiliary fuel pumps . . . . . OFF  
 Pitot heat . . . . . as required

**TAKEOFF**

**CAUTIONS**

Do not exceed 40 in. Hg. manifold pressure.

Fast taxi turns immediately prior to takeoff run can cause temporary malfunction of one engine during takeoff.

Normal sea level takeoff at 39 in. Hg. and 2575 RPM.

Adjust mixture prior to takeoff from high elevations. Do not over heat. Do not exceed 40 in. Hg. manifold pressure.

**NORMAL TAKEOFF (Flaps up)**

Flaps . . . . . UP  
 Accelerate to 66 to 71 KIAS.  
 Control wheel . . . . . ease back to  
 rotate to climb  
 attitude  
 After breaking ground, accelerate to best rate of  
 climb speed of 89 KIAS.  
 Gear . . . . . UP

**SHORT FIELD TAKEOFF (Flaps up)**

Flaps . . . . . UP  
 Stabilator trim . . . . . takeoff range  
 Brakes . . . . . set  
 Full power before brake release.  
 Accelerate to 66 KIAS.  
 Control wheel . . . . . rotate firmly to  
 attain 71 KIAS  
 through 50 ft.

Accelerate to best angle of climb speed of 76 KIAS  
 for obstacle clearance or best rate of climb speed of  
 89 KIAS, no obstacle.

Gear . . . . . UP

**SHORT FIELD TAKEOFF (25° Flaps)**

Flaps . . . . . 25° (second notch)  
Stabilator trim . . . . . set  
Brakes . . . . . set  
Full power before brake release.  
Accelerate to 61 KIAS.  
Control wheel . . . . . rotate firmly to  
attain 69 KIAS  
through 50 ft.  
Gear . . . . . UP

**TAKEOFF CLIMB**

Mixture . . . . . full RICH  
Prop speed . . . . . 2575 RPM  
Manifold pressure . . . . . DO NOT EXCEED  
40 in. Hg.  
Climb speed  
Best angle . . . . . 76 KIAS  
Best rate . . . . . 89 KIAS  
Cowl flaps . . . . . as required

**CRUISE CLIMB**

Mixture . . . . . full RICH  
Prop speed . . . . . 2450 RPM  
Manifold pressure . . . . . 31.5 in. Hg.  
Climb speed . . . . . 102 KIAS  
Cowl flaps . . . . . as required

**CRUISING**

Reference performance charts, Teledyne  
Continental Operator's Manual and power setting  
table.  
Power . . . . . set  
Cowl flaps . . . . . as required  
Mixture . . . . . adjust  
Engine gauges . . . . . monitor

**DESCENT**

Mixtures . . . . . enrich with descent  
Throttles . . . . . cruise setting  
Cowl flaps . . . . . CLOSED

**APPROACH AND LANDING**

Gear warning horn . . . . . check  
Airspeed . . . . . 98 KIAS on  
downwind leg  
Seat backs . . . . . erect  
Seat belts and harness . . . . . fasten adjust  
Fuel selectors . . . . . ON  
Cowl flaps . . . . . as required  
Auxiliary fuel pumps . . . . . OFF  
Mixture controls . . . . . set  
Propellers . . . . . 2250 RPM  
Landing gear . . . . . DOWN, 129 KIAS max.  
Flaps . . . . . set as required  
Airspeed . . . . . 97 KIAS on  
base leg,  
87 KIAS on final  
On close final:  
Power . . . . . reduced  
Prop. controls . . . . . full FORWARD

**GO-AROUND**

Full takeoff power, both engines (40 in. Hg. max.)  
Establish positive climb.  
Flaps . . . . . retract  
Gear . . . . . UP  
Cowl flaps . . . . . adjust

**AFTER LANDING**

Clear of runway  
Flaps . . . . . retract  
Cowl flaps . . . . . fully OPEN  
Alternate air . . . . . OFF

**SHUTDOWN**

Heater . . . . . FAN 2 min.  
then OFF  
Radio and electrical  
equipment . . . . . OFF  
Mixture controls . . . . . idle cut-off  
Magneto switches . . . . . OFF  
Master switch . . . . . OFF  
Parking brake . . . . . set ON

THIS PAGE INTENTIONALLY LEFT BLANK

#### 4.7 AMPLIFIED NORMAL PROCEDURES (GENERAL)

The following paragraphs are provided to supply detailed information and explanations of the normal procedures necessary for the operation of the airplane.

#### 4.9 PREPARATION

The airplane should be given a thorough preflight and walk-around check. The preflight should include a determination of the airplane's operational status, a check that necessary papers and charts are on board and in order, and a computation of weight and C.G. limits, takeoff distance and in-flight performance. Baggage should be weighed, stowed and tied down. Passengers should be briefed on the use of seat belts and shoulder harnesses, oxygen, and ventilation controls, advised when smoking is prohibited, and cautioned against handling or interfering with controls, equipment, door handles, etc. A weather briefing for the intended flight path should be obtained, and any other factors relating to a safe flight should be checked before takeoff.

#### 4.11 PREFLIGHT CHECK

##### CAUTION

The flap position should be noted before boarding the airplane. The flaps must be placed in the "UP" position before they will lock and support weight on the step.

Upon entering the cockpit, check that the landing gear selector is in the DOWN position, turn OFF all avionics equipment (to save power and prevent wear on the units), and turn the master switch ON. Check the landing gear indicator lights to insure that the three green lights have illuminated and the red light has not illuminated. Check the fuel supply. Adequate fuel should be indicated for the flight plus reserve. The cowl flaps should be OPEN to facilitate inspection and ensure cooling after engine start. Return the master switch to OFF to save the battery.

Check that the ignition switches are OFF and move the mixture controls to idle cut-off to prevent an inadvertent start while checking the propellers. Move the trim controls to neutral so that the tabs can be checked for alignment. Extend and retract the flaps to check for proper operation. This check is performed prior to engine start so that you can hear any noise which might indicate binding. The controls should be free and move properly. Drain the pitot and static system lines through the drains located on the side panel next to the pilot's seat. Fasten the seat belts on the empty seats. Before leaving the cockpit, drain the two crossfeed drains on the forward side of the spar box.

The first item to check during the walk-around is to insure that the crossfeed drains are closed. Check the right wing, aileron and flap hinges and surfaces for damage and ice. Make a close check of the right landing gear for leaks, proper piston exposure under a static load (3-1/2 inches) and that the tires are properly inflated and not excessively worn. The right wing tip and leading edge should be free from ice and damage.

Open the fuel cap to check the quantity and color of the fuel and cap vent. The vent should be free of obstructions. Secure the fuel cap properly. Proceeding around the engine nacelle, check the oil quantity (six to eight quarts). Make sure that the dipstick has properly seated after checking. Check and insure that the oil filler cap is securely tightened and secure the inspection door. Check the right propeller for nicks or leaks. The spinner should be secure and undamaged (check closely for cracks). The cowl flaps should be open and secure.

The right fuel drains should be opened to drain moisture and sediment. Drain the two fuel tank drains under the wing and the gascolator drain near the bottom of the engine nacelle (refer to Section 8 for more detailed draining procedure).

Check the nose section for damage and the nose landing gear for leaks and proper strut inflation. Under a normal static load, 2-1/2 inches of strut should be exposed. Check the tire for wear and proper inflation. If the tow bar was used, remove and stow. Before moving on to the forward baggage compartment, check the condition of the landing light. Open the forward baggage compartment and check to make sure that the baggage has been stowed properly. Close, secure and lock the baggage door. The key can be removed from the forward baggage compartment door in the locked position only.

At the front of the airplane, the windshield should be clean, secure and free from cracks or distortion. Moving around to the left wing, check the wing, engine nacelle and landing gear as described for the right side. Don't forget to check the fuel and oil.

If a pitot cover was installed, it should be removed before flight and the holes checked for obstructions. With the heated pitot switch on, check the heated pitot head and heated lift detector for proper heating. Check the stall warning vanes for movement and damage.

#### **CAUTION**

Care should be taken when an operational check of the heated pitot head and the heated lift detectors is being performed. Both units become very hot. Ground operation should be limited to 3 minutes maximum to avoid damaging the heating elements.

Latch the rear door securely and check the left static vent and dorsal fin air scoop for obstructions. The empennage should be free of ice and damage and all hinges should be secure. Check the stabilator for freedom of movement and ensure that the right static vent is unobstructed. Antennas should be secure and undamaged. After turning on the master switch and light switches in the cockpit, check the navigation and landing lights.

#### **4.13 BEFORE STARTING ENGINES**

Before starting the engines, adjust the seats and fasten the seat belts and shoulder harnesses. Set the parking brake and check to make sure all the circuit breakers are in and the radios are OFF. Cowl flaps should be OPEN and alternate air OFF. The alternators should now be switched ON.

#### **NOTE**

If the fixed shoulder harness (non-inertia reel type) is installed, it must be connected to the seat belt and adjusted to allow proper accessibility to all controls including fuel selector, flaps, trim, etc. while maintaining adequate restraint for the occupant.

If the inertia reel type shoulder harness is installed, a pull test of its locking restraint feature should be performed.



#### 4.15 STARTING ENGINES (AIRPLANE EQUIPPED WITH STANDARD ENGINE PRIMER SYSTEM)

The first step in starting is to move the fuel selector to the ON position. Advance the mixture control to full RICH, open the throttle half travel and move the propeller control full FORWARD. Turn the master switch and ignition switches ON. After ensuring that the propellers are clear, engage the starter. The primer button should be used (ON) as required. For cold weather starts, refer to paragraph 4.19 - Starting Engines in Cold Weather. When the engine starts, retard the throttle and monitor the oil pressure gauge. If no oil pressure is indicated within 30 seconds, shut down the engine and have it checked. In cold weather it may take somewhat longer for an oil pressure indication. Repeat the above procedure for the opposite engine. After the engines have started, check the alternators for sufficient output and the gyro pressure gauge for a reading between 4.5 and 5.2 in. Hg.

##### NOTE

To prevent starter damage, limit starter cranking to 30-second periods. If the engine does not start within that time, allow a cooling period of several minutes before engaging starter again. Do not engage the starter immediately after releasing it. This practice may damage the starter mechanism.

#### 4.16 STARTING ENGINES (AIRPLANE EQUIPPED WITH OPTIONAL ENGINE PRIMER SYSTEM)

##### NOTE

Engine starts can be accomplished down to ambient temperatures of +20°F with engines equipped with standard (massive electrode) spark plugs. Below that temperature fine wire spark plugs are highly recommended to ensure engine starts, and are a necessity at +10°F and below. In addition, the use of external electrical power source is also recommended when ambient temperatures are below +20°F.

Upon entering the cockpit, begin starting procedure by moving the fuel selector to ON. Advance the mixture to full RICH and the throttle and prop controls to full FORWARD. Turn the master switch and the ignition switch (mag.) ON. The auxiliary fuel pump should be OFF. Push primer switch and hold for the required priming time (see Figure 4-3). Close throttle and immediately engage starter. With ambient temperatures above +20°F, starts may be made by discontinuing priming before engaging starter. With ambient temperatures below +20°F, starts should be made by continuing to prime during cranking period. Do not release starter until engine accelerates through 500 RPM, then SLOWLY advance throttle to obtain 1000 RPM. Release primer and immediately place auxiliary fuel pump switch to LO. Auxiliary fuel pump operation will be required for one to three minutes initial engine warm-up. When starting at ambient temperatures of +20°F and below, operate the first engine started with alternator ON (at maximum charging rate not to exceed 1500 RPM) for 5 minutes minimum before initiating start on second engine.

##### NOTE

When cold weather engine starts are made without the use of engine preheating (refer to TCM Operator's Manual), longer than normal elapsed time may be required before an oil pressure indication is observed.

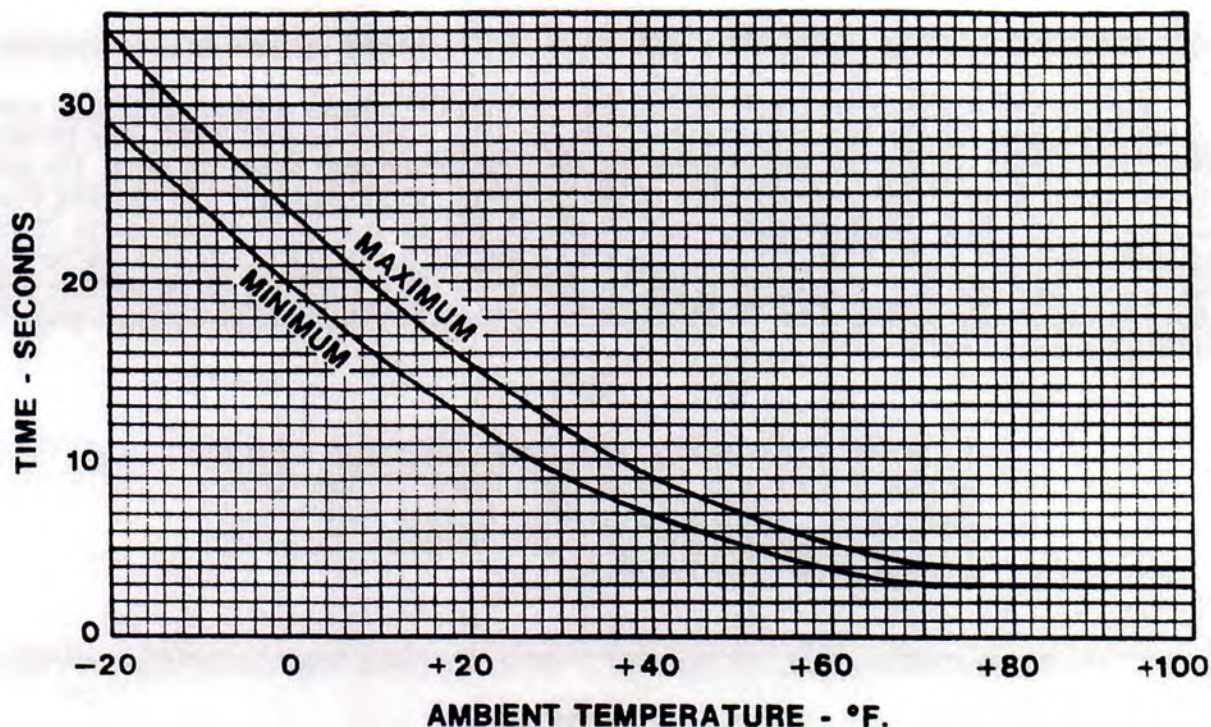

OPTIONAL ENGINE PRIMER SYSTEM - PRIMING TIME VS. AMBIENT TEMPERATURE

Figure 4-3

#### 4.17 STARTING ENGINES WHEN FLOODED

If an engine is flooded, move the mixture control to idle cut-off and advance the throttle and propeller controls full forward. Turn ON the master switch and ignition switches. The auxiliary fuel pump should be OFF. After ensuring that the propeller is clear, engage the starter. When the engine fires, retard the throttle and advance the mixture slowly.

#### 4.19 STARTING ENGINES IN COLD WEATHER (AIRPLANE EQUIPPED WITH STANDARD ENGINE PRIMER SYSTEM)

##### NOTE

As cold weather engine operations are decidedly more demanding, it may become necessary to utilize the starting procedure listed below in low ambient temperatures. (See Continental Engine Operator's Manual for Cold Weather Operating Recommendations.)

NOTE

It may be necessary to apply an external power source to facilitate engine cranking if the aircraft's battery is deficient of charge.

Prior to attempting the start, turn the propellers through by hand three times after insuring that the magneto switches are off and mixture controls are in the full aft position. Upon entering the cockpit, begin the starting procedure by moving the fuel selector to ON. Advance the mixture to full RICH and the throttle and prop controls to full FORWARD. Turn ON the master switch and the ignition switches (mags). The auxiliary fuel pump should be ON in the LOW boost position. Push the primer button and engage the starter simultaneously. Begin moving the throttle control back and forth from full forward to full aft. Release the primer button after about 3 seconds of cranking. Leave the primer button off for 3 seconds of cranking and then reapply primer for about 3 seconds, repeat until the engine begins to fire.

When the engine begins firing, leave the starter engaged and tap the primer periodically until a rhythmic firing pattern is observed and then release the starter switch and position the throttle at half travel. Tap the primer button if the engine begins to falter during this period and adjust the throttle to a 1000 RPM idle speed.

The auxiliary fuel pump may be turned OFF as soon as it is determined that the engine will continue to run without it.

#### 4.21 STARTING ENGINES WITH EXTERNAL POWER

An optional feature called the Piper External Power (PEP) allows the operator to use an external battery to crank the engines without having to gain access to the airplane's battery.

Turn the master switch OFF and turn all electrical equipment OFF. Connect the RED lead of the PEP kit jumper cable to the POSITIVE (+) terminal of an external 12-volt battery and the BLACK lead to the NEGATIVE (-) terminal. Insert the plug of the jumper cable into the socket located on the fuselage. Note that when the plug is inserted, the electrical system is ON. Proceed with the normal starting technique.

After the engines have started, reduce power to the lowest possible RPM, to reduce sparking, and disconnect the jumper cable from the aircraft. Turn the master switch ON and check the alternator ammeter for an indication of output. DO NOT ATTEMPT FLIGHT IF THERE IS NO INDICATION OF ALTERNATOR OUTPUT.

**NOTE**

For all normal operations using the PEP jumper cables, the master switch should be OFF, but it is possible to use the ships battery in parallel by turning the master switch ON. This will give longer cranking capabilities, but will not increase the amperage. CAUTION: Care should be exercised because if the ships battery has been depleted, the external power supply can be reduced to the level of the ships battery. This can be tested by turning the master switch ON momentarily while the starter is engaged. If cranking speed increases, the ships battery is at a higher level than the external power supply. If the battery has been depleted by excessive cranking, it must be recharged before the second engine is started. All the alternator current will go to the low battery until it receives sufficient charge, and it may not start the other engine immediately.

**4.23 TAXIING**

Remove chocks from the wheels and check to make sure the taxi area is clear. Always apply the throttles slowly.

Before taxiing, the brakes should be checked by moving forward a few feet, throttling back and applying pressure on the toe pedals. As much as possible, turns during taxiing should be made using rudder pedal motion and differential power (more power on the engine on the outside of the turn, less on the inside engine) rather than brakes.

During the taxi, check the instruments (turn indicator, directional gyro, coordination ball, compass) and the heater and defroster. Check the operation of the fuel management controls by moving each fuel selector to CROSSFEED for a short time, while the other selector is in the ON position. Return the selectors to the ON position. DO NOT attempt a takeoff with the fuel selector on CROSSFEED. The autopilot (if installed) should be off during taxi.

**4.25 BEFORE TAKEOFF - GROUND CHECK**

A thorough check should be made before takeoff, using a check list. Before advancing the throttle to check the magnetos and the propeller action, be sure that the engine oil temperature is 75°F or above.

During engine run-up, head the airplane into the wind if possible (see crosswind limits for propellers) and set the parking brake. Advance the mixture and propeller controls forward and the throttle controls to 1000 RPM. Drain the manifold pressure lines by depressing the drain valves located behind and below the dual manifold pressure gauge for 5 seconds. Do not depress the valves when the manifold pressure exceeds 25 inches Hg. Check the feather position of the propellers by bringing the controls fully aft and then full forward. Do not allow more than a 300 RPM drop during the feathering check. Move the throttles to 1900 RPM and exercise the propeller controls to check the function of the governor. Retard control until a 200 to 300 drop in RPM is indicated. This should be done three times on the first flight of the day. The governor can be checked by retarding the propeller control until a drop of 100 RPM to 200 RPM appears, then advancing the throttle to get a slight increase in manifold pressure. The propeller speed should stay the same when the throttle is advanced, thus indicating proper function of the governor.

Return the propeller controls to full forward and move the alternate air controls to ON then OFF. Check the magnetos. The normal drop on each magneto is 100 RPM and the maximum drop should not exceed 150 RPM. The maximum differential drop should not exceed 50 RPM. The alternator output should be approximately equal for both alternators. A 4.5 to 5.2 in. Hg. indication on the gyro pressure gauge signifies proper operation of the gyro pressure system.

#### CAUTION

Ensure that the alternators are not indicating full charge prior to takeoff.

Set the throttles between 800 and 1000 RPM, check that the fuel selectors and alternator switches are ON and that all the engine gauges are within their normal operating ranges (green arc). Press-to-test the annunciator light to make sure they all illuminate. Set the altimeter, attitude indicator and directional gyro. Wind and set the clock. Set the mixtures and advance the propeller controls in the forward position. The friction lock on the right side of the control quadrant should be adjusted. Check to make sure the alternate air is OFF. Adjust the cowl flaps and set the wing flaps and trim (stabilator and rudder) tabs as required. The seat backs should be erect and seat belts and harnesses fastened. Fasten the seat belts on the empty seats.

#### NOTE

If the fixed shoulder harness (non-inertia reel type) is installed, it must be connected to the seat belt and adjusted to allow proper accessibility to all controls including fuel selector, flaps, trim, etc. while maintaining adequate restraint for the occupant.

If the inertia reel type shoulder harness is installed, a pull test of its locking restraint feature should be performed.

All controls should be free with full travel, and all doors should be securely latched. Ensure that the auxiliary fuel pumps are OFF. Pitot heat should be used as required.

#### 4.27 TAKEOFF

The normally recommended procedure for sea level takeoff is to advance the throttle until a manifold pressure of 39 in. Hg. is indicated at 2575 RPM. During pretakeoff check at a high elevation, lean the mixture to obtain maximum power. Apply 40 in. Hg. manifold pressure; then lean the mixture until the fuel flow pointer stabilizes at a fuel consumption mark consistent with the altitude as shown on the green takeoff range on the gauge. Leave the mixture in this position for takeoff. Do not overheat the engine when operating with mixture leaned. If overheating occurs, enrich the mixture enough that temperature returns to normal.

#### NOTE

The "overboost" indicator lights on the annunciator panel will illuminate at approximately 39.8 in. Hg. manifold pressure. Do not exceed 40 in. Hg. manifold pressure.

Illumination of the yellow overboost light on the annunciator panel does not indicate a malfunction. The overboost lights illuminate when manifold pressure approaches the maximum limit. The overboost lights should be monitored during takeoff to insure that an overboost condition does not persist.

Takeoff should not be attempted with ice or frost on the wings. Takeoff distances and 50-foot obstacle clearance distances are shown on charts in the Performance Section of this Handbook. The performance shown on charts will be reduced by uphill gradient, tailwind component, or soft, wet, rough or grassy surface, or poor pilot technique.

Avoid fast turns onto the runway, followed by immediate takeoff, especially with a low fuel supply. Fast taxi turns immediately prior to takeoff run can cause temporary malfunction of one engine on takeoff. As power is applied at the start of the takeoff roll, look at the engine instruments to see that the engines are operating properly and putting out normal power, and at the airspeed indicator to see that it is functioning. Apply throttle smoothly until 40 in. Hg. manifold pressure is obtained. **DO NOT APPLY ADDITIONAL THROTTLES.**

**NOTE**

At altitudes below 12,000 feet, normal takeoffs are made with less than full throttle - use throttle only as required to obtain 40 in. Hg. manifold pressure. **DO NOT EXCEED 40 IN. HG. MANIFOLD PRESSURE.**

The flap setting for normal takeoff is  $0^\circ$ . In certain short field takeoff efforts when the shortest possible ground roll and the greatest clearance distance over a 50 ft. obstacle is desired, a flap setting of  $25^\circ$  is recommended.

When obstacle clearance is no problem, a normal flaps up ( $0^\circ$ ) takeoff may be used. Accelerate to 66-71 KIAS and ease back on the wheel enough to let the airplane lift off. After lift-off, accelerate to the best rate of climb speed, 89 KIAS, or higher if desired, retracting the landing gear when a gear-down landing is no longer possible on the runway.

When a short field effort is required but the situation presents a wide margin on obstacle clearance, the safest short field technique to use is with the flaps up ( $0^\circ$ ). In the event of an engine failure, the airplane is in the best flight configuration to sustain altitude immediately after the gear is raised. Set the stabilator trim indicator in the takeoff range. Set the brakes and bring the engines to full power before release. Accelerate to 66 KIAS and rotate the airplane firmly so that the airspeed is approximately 71 KIAS when passing through the 50-foot height. The airplane should then be allowed to accelerate to the best angle of climb speed (76 KIAS at sea level) if obstacle clearance is necessary, or best rate of climb speed (89 KIAS) if obstacles are not a problem. The landing gear should be retracted when a gear-down landing is no longer possible on the runway. The distances for this takeoff procedure are given on a chart in the Performance Section of this Handbook.

When the shortest possible ground roll and the greatest clearance distance over a 50-foot obstacle is desired, use a 25-degree flap setting (second notch). Set the stabilator trim indicator slightly nose up from the takeoff range. Set the brakes and bring the engines to full power before release. Accelerate to 61 KIAS and rotate firmly so that when passing through the 50-foot height the airspeed is approximately 69 KIAS. Retract the gear when a gear down landing is no longer possible on the runway.

It should be noted that the airplane is momentarily below  $V_{mc}$  when using the above procedure. IN THE EVENT THAT AN ENGINE FAILURE SHOULD OCCUR WHILE THE AIRPLANE IS BELOW  $V_{mc}$ , IT IS MANDATORY THAT THE THROTTLE ON THE OPERATING ENGINE BE RETARDED AND THE NOSE LOWERED IMMEDIATELY TO MAINTAIN CONTROL OF THE AIRPLANE. It should also be noted that when a 25-degree flap setting is used on the takeoff roll, an effort to hold the airplane on the runway too long may result in a "wheelbarrowing" tendency. This should be avoided.

The distances required using this takeoff procedure are given on a chart in the Performance Section of this Handbook.

#### 4.29 CLIMB

On climb-out after takeoff, it is recommended that the best angle of climb speed (76 KIAS) be maintained only if obstacle clearance is a consideration. The best rate of climb speed (89 KIAS) should be maintained with full power on the engines until adequate terrain clearance is obtained. At this point, engine power should be reduced to 31.5 inches manifold pressure and 2450 RPM (approximately 75% power) for cruise climb. A cruise climb speed of 102 KIAS or higher is also recommended. This combination of reduced power and increased climb speed provides better engine cooling, less engine wear, reduced fuel consumption, lower cabin noise level, and better forward visibility.

When reducing engine power the throttles should be retarded first, followed by the propeller controls. The mixture controls should remain at full rich during the climb. Cowl flaps should be adjusted to maintain cylinder head and oil temperatures within the normal ranges specified for the engine. During climbs under hot weather conditions, it may be necessary to use LO auxiliary fuel pump for vapor suppression.

Consistent operational use of cruise climb power settings is strongly recommended since this practice will make a substantial contribution to fuel economy and increased engine life, and will reduce the incidence of premature engine overhauls.

#### **4.31 CRUISING**

When leveling off at cruise altitude, the pilot may reduce to a cruise power setting in accordance with the Power Setting Table in this Handbook. The mixture should be leaned in accordance with the recommendations for the engine in the Teledyne-Continental Operator's Manual which is provided with the aircraft. If cylinder head temperatures become too high during flight, reduce them by enriching the mixture, by opening cowl flaps, by reducing power, or by use of any combination of these methods.

Following level-off for cruise, the cowl flaps should be closed or adjusted as necessary to maintain proper cylinder head temperatures, and the airplane should be trimmed to fly hands off.

The pilot should monitor weather conditions while flying and should be alert to conditions which might lead to icing. If induction system icing is expected, place the alternate air control in the "ON" position.

#### **WARNING**

Flight in icing conditions is prohibited unless aircraft is equipped with the approved and complete Piper ice protection system (see paragraph 4.47). If icing is encountered, immediate action should be taken to fly out of icing conditions. Icing is hazardous due to greatly reduced performance, loss of forward visibility, possible longitudinal control difficulties due to increased control sensitivity, and impaired power plant and fuel system operation.

The ammeters for the electrical system should be monitored during flight, especially during night or instrument flight, so that corrective measures can be taken in case of malfunction. The procedures for dealing with electrical failures are contained in the Emergency Procedure Section of this Handbook. The sooner a problem is recognized and corrective action taken, the greater is the chance of avoiding total electrical failure. Both alternator switches should be ON for normal operation. The two ammeters continuously indicate the alternator outputs. Certain regulator failures can cause the alternator output voltage to increase uncontrollably. To prevent damage, overvoltage relays are installed to automatically shut off the alternator(s). The alternator light on the annunciator panel will illuminate to warn of the tripped condition. Alternator outputs will vary with the electrical equipment in use and the state of charge of the battery. Alternator outputs should not exceed 65 amperes.



It is not recommended to takeoff into IFR operation with a single alternator. During flight, electrical loads should be limited to 50 amperes for each alternator. Although the alternators are capable of 65 amperes output, limiting loads to 50 amperes will assure battery charging current.

Since the Seneca has one combined fuel tank per engine, it is advisable to feed the engines symmetrically during cruise so that approximately the same amount of fuel will be left in each side for the landing. A crossfeed is provided and can be used to even up the fuel, if necessary. After 30 minutes of flight, it is permissible to operate both engines from the same tank through the crossfeed. Monitor the fuel quantity for the tank not being used to avoid overflow due to vapor return.

During flight, keep account of time and fuel used in connection with power settings to determine how the fuel flow and fuel quantity gauging systems are operating. If the fuel flow indication is considerably higher than the fuel actually being consumed or if an asymmetric flow gauge indication is observed, a fuel nozzle may be clogged and require cleaning.

There are no mechanical uplocks in the landing gear system. In the event of a hydraulic system malfunction, the landing gear will free-fall to the gear down position. The true airspeed with gear down is approximately 75% of the gear retracted airspeed for any given power setting. Allowances for the reduction in airspeed and range should be made when planning extended flight between remote airfields or flight over water.

For flight above 12,500 feet see FAR 91.32 requirements for oxygen and Section 9 - Supplements in this Handbook.

#### 4.33 DESCENT

When power is reduced for descent, the mixtures should be enriched as altitude decreases. The propellers may be left at cruise setting; however if the propeller speed is reduced, it should be done after the throttles have been retarded. Cowl flaps should normally be closed to keep the engines at the proper operating temperature.

### **4.35 APPROACH AND LANDING**

Sometime during the approach for a landing, the throttle controls should be retarded to check the gear warning horn. Flying the airplane with the horn inoperative is not advisable. Doing so can lead to a gear up landing as it is easy to forget the landing gear, especially when approaching for a single-engine landing, or when other equipment is inoperative, or when attention is drawn to events outside the cabin. The red landing gear unsafe light will illuminate when the landing gear is in transition between the full up position and the down and locked position. Additionally, the light will illuminate when the gear warning horn sounds. The gear warning horn will sound at low throttle settings if the gear is not down and locked.

The light is off when the landing gear is in either the full down and locked or full up positions.

Prior to entering the traffic pattern, the aircraft should be slowed to approximately 98 KIAS and this speed should be maintained on the downwind leg. The landing check should be made on the downwind leg. The seat backs should be erect and the seat belts and shoulder harnesses fastened. Both fuel selectors should be ON and the cowl flaps set as required. The auxiliary fuel pumps should be OFF. Set the mixture controls and adjust the propellers to 2250 RPM. Select landing gear DOWN and check for three green lights on the panel and look for the nose wheel in the nose wheel mirror. The landing gear should be lowered at speeds below 129 KIAS and the flaps at speeds as follow:

- 10° (first notch) 138 KIAS maximum
- 25° (second notch) 121 KIAS maximum
- 40° (third notch) 107 KIAS maximum

#### **NOTE**

If the fixed shoulder harness (non-inertia reel type) is installed, it must be connected to the seat belt and adjusted to allow proper accessibility to all controls including fuel selector, flaps, trim, etc. while maintaining adequate restraint for the occupant.

If the inertia reel type shoulder harness is installed, a pull test of its locking restraint feature should be performed.

Maintain a traffic pattern speed of 98 KIAS and a final approach speed of 83 KIAS. If the aircraft is lightly loaded, the final approach speed may be reduced to 79 KIAS.

When the power is reduced on close final approach, the propeller controls should be advanced to the full forward position to provide maximum power in the event of a go-around.

The landing gear position should be checked on the downwind leg and again on final approach by checking the three green indicator lights on the instrument panel and looking at the external mirror to check that the nose gear is extended. Remember that when the navigation lights are on, the gear position lights are dimmed and are difficult to see in the daytime.

Flap position for landing will depend on runway length and surface wind. Full flaps will reduce stall speed during final approach and will permit contact with the runway at a slower speed. Good pattern management includes a smooth, gradual reduction of power on final approach, with the power fully off before the wheels touch the runway. This gives the gear warning horn a chance to blow if the gear is not locked down. If electric trim is available, it can be used to assist a smooth back pressure during flare-out.

Maximum braking after touch-down is achieved by retracting the flaps, applying back pressure to the wheel and applying pressure on the brakes. However, unless extra braking is needed or unless a strong crosswind or gusty air condition exists, it is best to wait until turning off the runway to retract the flaps. This will permit full attention to be given to the landing and landing roll, and will also prevent the pilot's accidentally reaching for the gear handle instead of the flap handle.

For a normal landing, approach with full flaps (40°) and partial power until shortly before touch-down. Hold the nose up as long as possible before and after contacting the ground with the main wheels.

Approach with full flaps at 78 KIAS for a short field landing. Immediately after touch-down, raise the flaps, apply back pressure to the wheel and apply brakes.

If a crosswind or high-wind landing is necessary, approach with higher than normal speed and with zero to 25 degrees of flaps. Immediately after touch-down, raise the flaps. During a crosswind approach hold a crab angle into the wind until ready to flare out for the landing. Then lower the wing that is into the wind, to eliminate the crab angle without drifting, and use the rudder to keep the wheels aligned with the runway. Avoid prolonged side slips with a low fuel indication.

The maximum demonstrated crosswind component for landing is 17 KTS.

#### 4.37 GO-AROUND

If a go-around from a normal approach with the airplane in the landing configuration becomes necessary, apply takeoff power to both engines (not to exceed 40 in. Hg. manifold pressure). Establish a positive climb attitude, retract the flaps and landing gear and adjust the cowl flap for adequate engine cooling.

#### 4.39 AFTER LANDING

After leaving the runway, retract the flaps and open the cowl flaps. Test the toe brakes, a spongy pedal is often an indication that the brake fluid needs replenished. The alternate air control should be OFF.

#### **4.41 SHUTDOWN**

Prior to shutdown, switch the heater (if on) to the FAN position for a few minutes for cooling and then turn it OFF. All radio and electrical equipment should be turned OFF.

Move the mixture controls to idle cut-off. Turn OFF the magneto and master switches and set the parking brake.

#### **NOTE**

The flaps must be placed in the "UP" position for the flap step to support weight. Passengers should be cautioned accordingly.

#### **4.43 MOORING**

The airplane can be moved on the ground with the aid of the optional nose wheel tow bar stowed aft of the fifth and sixth seats. Tie-down ropes may be attached to mooring rings under each wing and to the tail skid. The ailerons and stabilator should be secured by looping the seat belt through the control wheel and pulling it snug. The rudder need not be secured under normal conditions, as its connection to the nose wheel holds it in position. The flaps are locked when in the fully retracted position.

#### **4.45 TURBULENT AIR OPERATION**

In keeping with good operating practice used in all aircraft, it is recommended that when turbulent air is encountered or expected, the airspeed be reduced to maneuvering speed to reduce the structural loads caused by gusts and to allow for inadvertent speed build-ups which may occur as a result of the turbulence or of distractions caused by the conditions. (See Subsection 2.3)

#### 4.47 FLIGHT INTO KNOWN ICING CONDITIONS

The Piper Seneca II is approved for flight into known icing conditions when equipped with the complete Piper Ice Protection System\* Operating in icing conditions in excess of the Continuous Maximum and Intermittent Maximum as defined in FAR 25, Appendix C has been substantiated; however, there is no correlation between these conditions and forecast or reported "Light, Moderate and Severe" conditions. Therefore, on the basis of flight tests, the following guidelines should be observed:

- (a) Flight into severe icing is prohibited.
- (b) Moderate icing conditions above 10,000 ft. should be avoided whenever possible; if moderate icing conditions are encountered above 10,000 ft., a descent to a lower altitude should be initiated if practical.
- (c) Operation in light icing is approved at all altitudes.

Icing conditions of any kind should be avoided wherever possible, since any minor malfunction which may occur is potentially more serious in icing conditions. Continuous attention of the pilot is required to monitor the rate of ice buildup in order to effect the boot cycle at the optimum time. Boots should be cycled when ice has built to between 1/4 and 1/2 inch thickness on the leading edge to assure proper ice removal. Repeated boot cycles at less than 1/4 inch can cause a cavity to form under the ice and prevent ice removal; boot cycles at thicknesses greater than 1/2 may also fail to remove ice.

Icing conditions can exist in any clouds when the temperature is below freezing; therefore it is necessary to closely monitor outside air temperature when flying in clouds or precipitation. Clouds which are dark and have sharply defined edges have high water content and should be avoided whenever possible. Freezing rain must always be avoided.

Prior to dispatch into forecast icing conditions all ice protection should be functionally checked for proper operation. Before entering probable icing conditions use the following procedures:

- (a) Windshield defroster - on (immediately)
- (b) Pitot heat - on (immediately)
- (c) Windshield heat - on (when entering icing conditions)
- (d) Propeller deice - on (when entering icing conditions)
- (e) Wing deice - on (after 1/4 to 1/2 inch accumulation)
- (f) Relieve propeller unbalance (if required) by increasing RPM briefly. Repeat as required.

#### WARNING

Do not cycle pneumatic boots with less than 1/4 inch of ice accumulation; operation of boots with less than 1/4 inch ice accumulation can result in failure to remove ice. Do not hold momentary surface deice switch ON.

\*Optional equipment

Heat for the lift detectors is activated by the pitot heat switch. When ice has accumulated on the unprotected surfaces of the airplane, aerodynamic buffet commences between 5 and 10 knots above the stall speed. A substantial margin of airspeed should be maintained above the normal stall speeds, since the stall speed may increase by up to 10 knots in prolonged icing encounters.

If ice is remaining on the unprotected surfaces of the airplane at the termination of the flight, the landing should be made using full flaps and carrying a slight amount of power whenever practical, and approach speeds should be increased by 10 to 15 knots.

Cruise speed may be significantly reduced in prolonged icing encounters. If icing conditions are encountered at altitudes above 10,000 feet, it may be necessary to descend in order to maintain airspeed above the best rate of climb speed (89 KIAS).

**NOTE**

Pneumatic boots must be regularly cleaned and waxed for proper operation in icing conditions. Pitot, windshield and lift detector heat should be checked on the ground before dispatch into icing conditions.

Installation of ice protection equipment results in a 30 FPM decrease in single engine climb rate and a reduction of 850 feet in single engine service ceiling.

#### 4.49 FLIGHT WITH REAR CABIN AND CARGO DOORS REMOVED

The airplane is approved for flight with the rear cabin and cargo doors removed. Certain limitations must be observed in the operation of this airplane in this configuration.

The maximum speed with doors removed is 129 KIAS. The minimum single engine control speed is 67 KIAS. Smoking is not permitted and all loose articles must be tied down and stowed. The jumper's static lines must be kept free of pilot's controls and control surfaces. Operation is approved for VFR non-icing flight conditions only. It is recommended that all occupants wear parachutes when operating with the rear cabin and cargo doors removed.

All climb and cruise performance will be reduced by approximately five percent when the airplane is operated with the rear cabin and cargo doors removed.

#### 4.50 VSSE - INTENTIONAL ONE ENGINE INOPERATIVE SPEED

Vs<sub>se</sub> is a speed selected by the aircraft manufacturer as a training aid for pilot's in the handling of multi-engine aircraft. It is the minimum speed for intentionally rendering one engine inoperative in flight. This minimum speed provides the margin the manufacturer recommends for use when intentionally performing engine inoperative maneuvers during training in the particular airplane.

The intentional one engine inoperative speed, Vs<sub>se</sub>, for the Seneca II is 76 KIAS.

#### **4.51 VMC - MINIMUM SINGLE-ENGINE CONTROL SPEED**

Vmc is airspeed below which a twin-engine aircraft cannot be controlled in flight with one engine operating at takeoff power and the other engine windmilling. Vmc for the Seneca II has been determined to be 66 KIAS. Under no circumstances should an attempt be made to fly at a speed below this Vmc with only one engine operating. As a safety precaution, when operating under single-engine flight conditions either in training or in emergency situations, maintain an indicated airspeed above 76 KIAS, Vsse. Reduce airspeed approximately 1 knot per second until Vmc is reached.

The Vmc demonstration required for the FAA flight test for the multi-engine rating approaches an uncontrolled flight condition with power reduced on one engine. The demonstration should not be performed at an altitude of less than 3500 feet above the ground. Initiate recovery during the demonstration by immediately reducing power on the operating engine and promptly lowering the nose of the airplane to accelerate to Vsse.

In the Seneca II, more power is available on the operating engine at higher altitudes with the same manifold pressure; hence, there can be more asymmetric thrust. The Vmc in the Seneca II is lowest at low altitudes, and the airplane will approach a stall before reaching Vmc. The most critical situation occurs at the altitude where the stall speed and Vmc speed coincide. Care should be taken to avoid this flight condition, because at this point loss of directional control occurs at the same time the airplane stalls, and spin could result.

#### **NOTE**

Single-engine stalls are not recommended.

#### **4.53 STALLS**

The loss of altitude during a power off stall with the gear and flaps retracted may be as much as 400 feet. The loss of altitude with the gear down and 40° of flaps may also be as much as 400 feet.

A power on stall may result in as much as 150 feet of altitude loss.

The stall warning system is inoperative with the master switch OFF.



(2) Revise the FAA-approved AFM by incorporating the following into the Normal Procedures Section of the AFM. This may be accomplished by inserting a copy of this AD in the AFM.

**"THE FOLLOWING WEATHER CONDITIONS  
MAY BE CONDUCTIVE TO SEVERE  
IN-FLIGHT ICING:**

- Visible rain at temperatures below 0 degrees Celsius ambient air temperature.
- Droplets that splash or splatter on impact at temperatures below 0 degrees Celsius ambient air temperature.

**PROCEDURES FOR EXITING  
THE SEVERE ICING ENVIRONMENT:**

- These procedures are applicable to all flight phases from takeoff to landing. Monitor the ambient air temperature. While severe icing may form at temperatures as cold as -18 degrees Celsius, increased vigilance is warranted at temperatures around freezing with visible moisture present. If the visual cues specified in the Limitations Section of the AFM for identifying severe icing conditions are observed, accomplish the following:
  - Immediately request priority handling from Air Traffic Control to facilitate a route or an altitude change to exit the severe icing conditions in order to avoid extended exposure to flight conditions more severe than those for which the airplane has been certificated.
  - Avoid abrupt and excessive maneuvering that may exacerbate control difficulties.
  - Do not engage the autopilot.
  - If the autopilot is engaged, hold the control wheel firmly and disengage the autopilot.
  - If an unusual roll response or uncommanded roll control movement is observed, reduce the angle-of-attack.
  - Do not extend flaps when holding in icing conditions. Operation with flaps extended can result in a reduced wing angle-of-attack, with the possibility of ice forming on the upper surface further aft on the wing than normal, possibly aft of the protected area.
  - If the flaps are extended, do not retract them until the airframe is clear of ice.
  - Report these weather conditions to Air Traffic Control."

THE UNIVERSITY OF CHICAGO  
DEPARTMENT OF CHEMISTRY  
5408 S. UNIVERSITY AVENUE  
CHICAGO, ILLINOIS 60637

RECEIVED  
JAN 15 1964

TO THE DIRECTOR  
FROM THE DEPARTMENT OF CHEMISTRY  
RE: [Illegible]

[Illegible text]

[Illegible text]

[Illegible text]

**TABLE OF CONTENTS**

**SECTION 5**

**PERFORMANCE**

<b>Paragraph No.</b>		<b>Page No.</b>
5.1	General . . . . .	5-1
5.3	Introduction to Performance and Flight Planning . . . . .	5-1
5.5	Flight Planning Example . . . . .	5-3
5.7	Performance Graphs . . . . .	5-9
	List of Figures . . . . .	5-9

三  
三  
三

3

3

3

**SECTION 5  
PERFORMANCE**

**5.1 GENERAL**

All of the required (FAA regulations) and complementary performance information applicable to the Seneca II is provided by this section.

Performance information associated with those optional systems and equipment which require handbook supplements is provided by Section 9 (Supplements).

The performance data presented in this section is applicable to both two and three bladed propeller installations.

**5.3 INTRODUCTION TO PERFORMANCE AND FLIGHT PLANNING**

The performance information presented in this section is based on measured Flight Test Data corrected to I.C.A.O. standard day conditions and analytically expanded for the various parameters of weight, altitude, temperature, etc.

The performance charts are unfactored and do not make any allowance for varying degrees of pilot proficiency or mechanical deterioration of the aircraft. This performance, however, can be duplicated by following the stated procedures in a properly maintained airplane.

Effects of conditions not considered on the charts must be evaluated by the pilot, such as the effect of soft or grass runway surface on takeoff and landing performance, or the effect of winds aloft on cruise and range performance. Endurance can be grossly affected by improper leaning procedures, and inflight fuel flow and quantity checks are recommended.

**REMEMBER!** To get chart performance, follow the chart procedures.

The information provided by paragraph 5.5 (Flight Planning Example) outlines a detailed flight plan using the performance charts in this section. Each chart includes its own example to show how it is used.

**WARNING**

Performance information derived by extrapolation beyond the limits shown on the chart should not be used for flight planning purposes.

**THIS PAGE INTENTIONALLY LEFT BLANK**

## 5.5 FLIGHT PLANNING EXAMPLE

### (a) Aircraft Loading

The first step in planning our flight is to calculate the airplane weight and center of gravity by utilizing the information provided by Section 6 (Weight and Balance) of this handbook.

The basic empty weight for the airplane as delivered from the factory has been entered in Figure 6-5. If any alterations to the airplane have been made effecting weight and balance, reference to the aircraft logbook and Weight and Balance Record (Figure 6-7) should be made to determine the current basic empty weight of the airplane.

Make use of the Weight and Balance Loading Form (Figure 6-11) and the C.G. Range and Weight graph (Figure 6-15) to determine the total weight of the airplane and the center of gravity position.

After proper utilization of the information provided we have found the following weights for consideration in our flight planning example.

The landing weight cannot be determined until the weight of the fuel to be used has been established [refer to item (g)(1)].

(1) Basic Empty Weight	2790 lbs.
(2) Occupants (3 x 170 lbs.)	510 lbs.
(3) Baggage and Cargo	420 lbs.
(4) Zero Fuel Weight (4000 lb. max. allowable)	3720 lbs.
(5) Fuel (6 lb./gal. x 95)	570 lbs.
(6) Takeoff Weight (4570 lb. max. allowable)	4290 lbs.
(7) Landing Weight (4342 lb. max. allowable)	
(a)(6) minus (g)(1), (4290 lbs. minus 303 lbs.)	3987 lbs.

Our takeoff and landing weights are below the maximums and our weight and balance calculations have determined our C.G. position within the approved limits.

### (b) Takeoff and Landing

Now that we have determined our aircraft loading, we must consider all aspects of our takeoff and landing.

All of the existing conditions at the departure and destination airport must be acquired, evaluated and maintained throughout the flight.

Apply the departure airport conditions and takeoff weight to the appropriate Takeoff Performance and Takeoff Ground Roll graph (Figures 5-11, 5-13, 5-15 and 5-17) to determine the length of runway necessary for the takeoff and/or the barrier distance.

The landing distance calculations are performed in the same manner using the existing conditions at the destination airport and, when established, the landing weight.

The conditions and calculations for our example flight are listed below. The takeoff and landing distances required for our example flight have fallen well below the available runway lengths.

	Departure Airport	Destination Airport
(1) Pressure Altitude	7586 ft.	4411 ft.
(2) Temperature	40°F	50°F
(3) Wind Component	10 KTS (Headwind)	5 KTS (Headwind)
(4) Runway Length Available	7400 ft.	9000 ft.
(5) Runway Required		
Takeoff	1540 ft.*	
Accelerate and Stop	4400 ft.**	
Landing		2590 ft.***

**NOTE**

The remainder of the performance charts used in this flight plan example assume a no wind condition. The effect of winds aloft must be considered by the pilot when computing climb, cruise and descent performance.

**(c) . Climb**

The next step in our flight plan is to determine the necessary climb segment components.

The desired cruise pressure altitude and corresponding cruise outside air temperature values are the first variables to be considered in determining the climb components from the Time, Fuel, and Distance to Climb graph (Figure 5-21). After the time, fuel and distance for the cruise pressure altitude and outside air temperature values have been established, apply the existing conditions at the departure field to graph (Figure 5-21). Now, subtract the values obtained from the graph for the field of departure conditions from those for the cruise pressure altitude.

The remaining values are the true time, fuel and distance components for the climb segment of the flight plan corrected for field pressure altitude and temperature.

The following values were determined from the above instructions in our flight planning example.

(1) Cruise Pressure Altitude	16,500 ft.
(2) Cruise OAT	8°F
(3) Time to Climb (15 min. minus 6 min.)	9 min.****
(4) Distance to Climb (26 naut. miles minus 10 naut. miles)	16 naut. miles****
(5) Fuel to Climb (12 gal. minus 4 gal.)	8 gal.****

\*reference Figure 5-15

\*\*reference Figure 5-7

\*\*\*reference Figure 5-35

\*\*\*\*reference Figure 5-21



(d) Descent

The descent data will be determined prior to the cruise data to provide the descent distance for establishing the total cruise distance.

Utilizing the cruise pressure altitude and OAT we determine the basic time, fuel and distance for descent (Figure 5-33). These figures must be adjusted for the field pressure altitude and temperature at the destination airport. To find the necessary adjustment values, use the existing pressure altitude and temperature conditions at the destination airport as variables to find the time, fuel and distance values from the graph (Figure 5-33). Now, subtract the values obtained from the field conditions from the values obtained from the cruise conditions to find the true time, fuel and distance values needed for the flight plan.

The values obtained by proper utilization of the graphs for the descent segment of our example are shown below.

(1) Time to Descend (18.5 min. minus 4.5 min.)	14 min.*
(2) Distance to Descend (40 naut. miles minus 10 naut. miles)	30 naut. miles*
(3) Fuel to Descend (5 gal. minus 1.5 gal.)	3.5 gal.*

(e) Cruise

Using the total distance to be traveled during the flight, subtract the previously calculated distance to climb and distance to descend to establish the total cruise distance. Refer to the appropriate Teledyne Continental Motors Operator's Manual and the Power Setting Tables (Figures 5-23 or 5-25) when selecting the cruise power setting. The established pressure altitude and temperature values and the selected cruise power should now be utilized to determine the true airspeed from the Speed Power graph (Figure 5-31).

Calculate the cruise fuel flow for the cruise power setting from the information provided by the Teledyne Continental Motors Operator's Manual.

The cruise time is found by dividing the cruise distance by the cruise speed and the cruise fuel is found by multiplying the cruise fuel flow by the cruise time.

The cruise calculations established for the cruise segment of our flight planning example are as follows:

(1) Total Distance	394 miles
(2) Cruise Distance	
(e)(1) minus (c)(4) minus (d)(2), (394 naut. miles minus 16 naut. miles minus 30 naut. miles)	348 naut. miles
(3) Cruise Power	55% rated power
(4) Cruise Speed	161 KTS TAS**
(5) Cruise Fuel Consumption	18 GPH***
(6) Cruise Time	
(e)(2) divided by (e)(4), (348 naut. miles divided by 161 KTS)	2.16 hrs.
(7) Cruise Fuel	
(e)(5) multiplied by (e)(6), (18 GPH multiplied by 2.16 hrs.)	39 gal.

\*reference Figure 5-33

\*\*reference Figure 5-31

\*\*\*reference Figure 5-23

(f) Total Flight Time

The total flight time is determined by adding the time to climb, the time to descend and the cruise time. Remember! The time values taken from the climb and descent graphs are in minutes and must be converted to hours before adding them to the cruise time.

The following flight time is required for our flight planning example.

(1) Total Flight Time  
(c)(3) plus (d)(1) plus (e)(6). (.15 hrs. plus .23 hrs. plus 2.16 hrs.) 2.54 hrs.

(g) Total Fuel Required

Determine the total fuel required by adding the fuel to climb, the fuel to descend and the cruise fuel. When the total fuel (in gallons) is determined, multiply this value by 6 lb./gal. to determine the total fuel weight used for the flight.

The total fuel calculations for our example flight plan are shown below.

(1) Total Fuel Required  
(c)(5) plus (d)(3) plus (e)(7). (8 gal. plus 3.5 gal. plus 39 gal.) 50.5 gal.  
(50.5 gal. multiplied by 6 lb. gal.) 303 lbs.

**THIS PAGE INTENTIONALLY LEFT BLANK**

**THIS PAGE INTENTIONALLY LEFT BLANK**

5.7 PERFORMANCE GRAPHS

LIST OF FIGURES

Figure No.		Page No.
5-1	Airspeed Correction - Normal System . . . . .	5-11
5-3	Altimeter Correction - Normal System . . . . .	5-12
5-5	Stall Speeds . . . . .	5-13
5-7	Accelerate and Stop Distance (Standard) . . . . .	5-14
5-9	Accelerate and Stop Distance (Heavy Duty Group 1) . . . . .	5-15
5-11	Takeoff Ground Roll - Normal Procedure . . . . .	5-16
5-13	Takeoff Ground Roll - Short Field Effort . . . . .	5-17
5-15	Takeoff Distance - Normal Procedure . . . . .	5-18
5-17	Takeoff Distance - Short Field Effort . . . . .	5-19
5-19	Climb Performance . . . . .	5-20
5-21	Time, Fuel and Distance to Climb . . . . .	5-21
5-23	Power Setting Table (45% and 55%) . . . . .	5-22
5-25	Power Setting Table (65% and 75%) . . . . .	5-23
5-26	Non-Standard Temperature Range with Maximum Power Climb (93 Usable Gal.) . . . . .	5-24
5-27	Standard Temperature Range with Maximum Power Climb (93 Usable Gal.) . . . . .	5-25
5-28	Non-Standard Temperature Range with Maximum Power Climb (123 Usable Gal.) . . . . .	5-26
5-29	Standard Temperature Range with Maximum Power Climb (123 Usable Gal.) . . . . .	5-26a
5-31	Speed Power . . . . .	5-27
5-33	Time, Fuel and Distance to Descend . . . . .	5-28
5-35	Landing Distance - Normal Procedure (Standard) . . . . .	5-29
5-37	Landing Distance - Short Field Effort (Standard) . . . . .	5-30
5-39	Landing Distance - Normal Procedure (Heavy Duty Group 1) . . . . .	5-31
5-41	Landing Distance - Short Field Effort (Heavy Duty Group 1) . . . . .	5-32
5-43	Landing Ground Roll - Normal Procedure (Standard) . . . . .	5-33
5-45	Landing Ground Roll (Heavy Duty Group 1) . . . . .	5-34

THIS PAGE INTENTIONALLY LEFT BLANK

# PA-34-200T

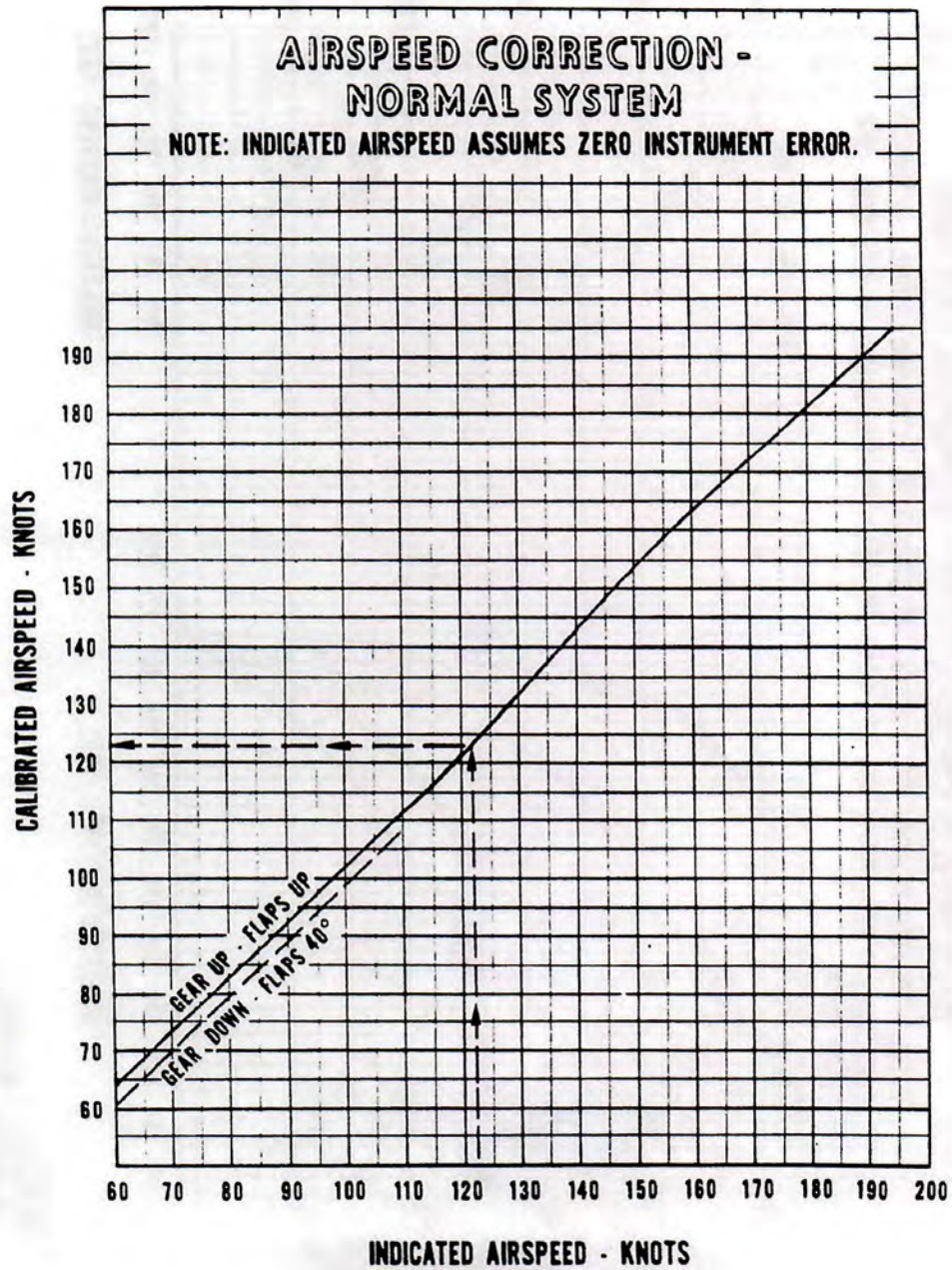

Example:  
122 KIAS = 123 KCAS

**AIRSPEED CORRECTION - NORMAL SYSTEM**

Figure 5-1

# PA-34-200T

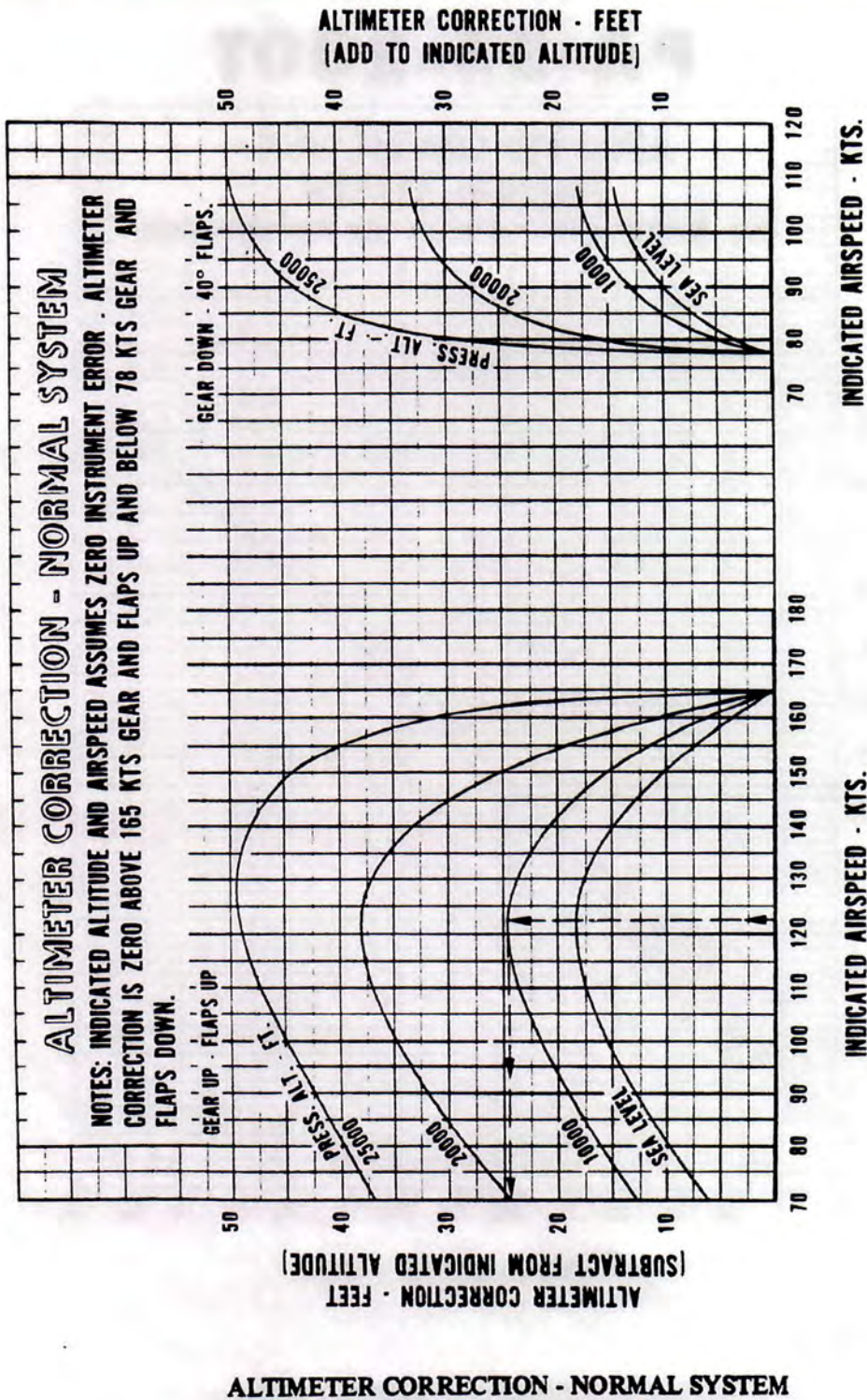
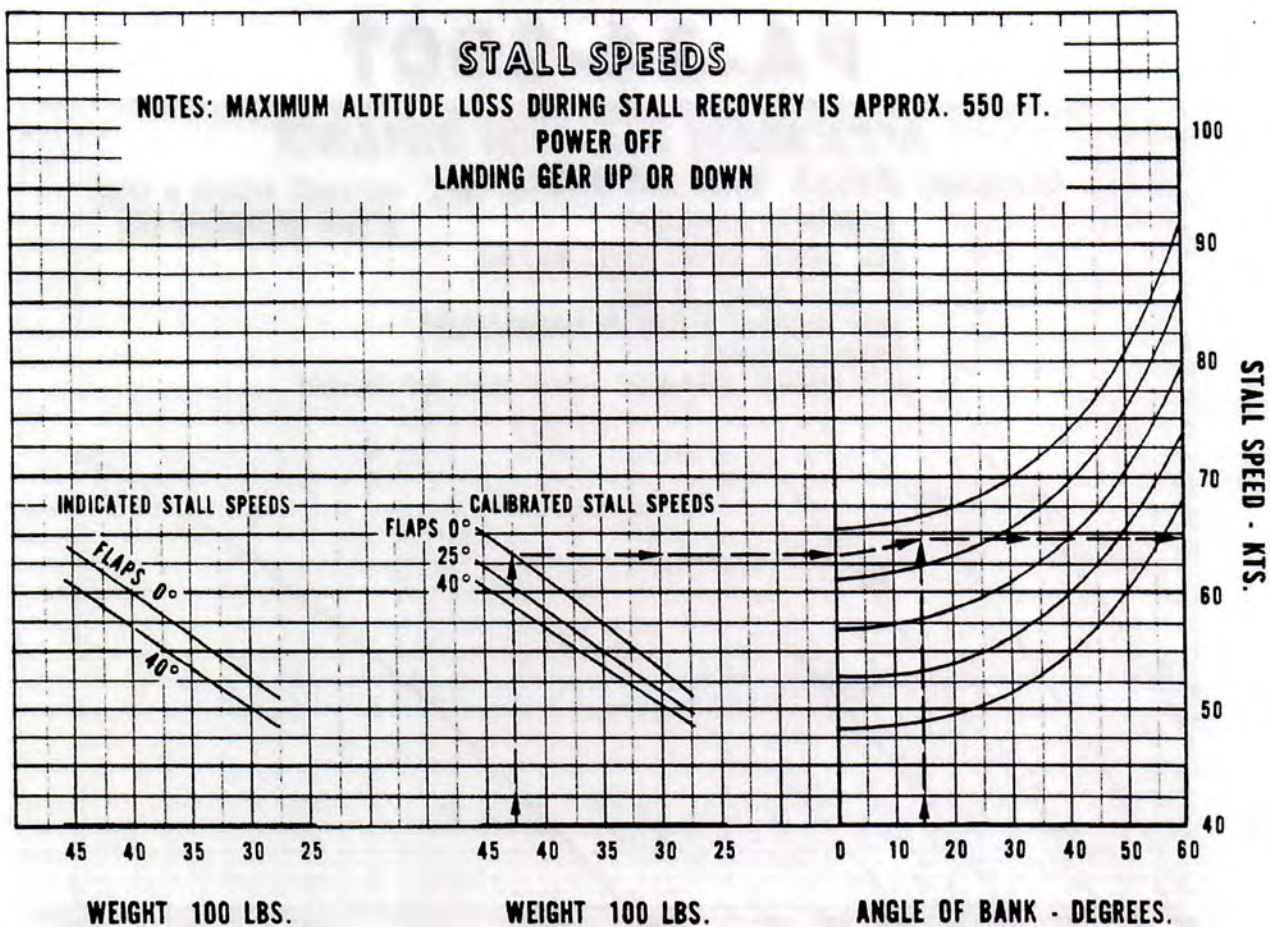

Figure 5-3

Example:  
Airspeed: 122 KIAS  
Pressure altitude: 10,000 ft.  
Indicated altitude: Subtract 24 ft.



# PA-34-200T



**Example:**

Gross weight: 4250 lbs.  
Angle of bank: 15°  
Flap position: 0°  
Calibrated stall speed: 64 knots

**STALL SPEEDS**

Figure 5-5

# PA-34-200T

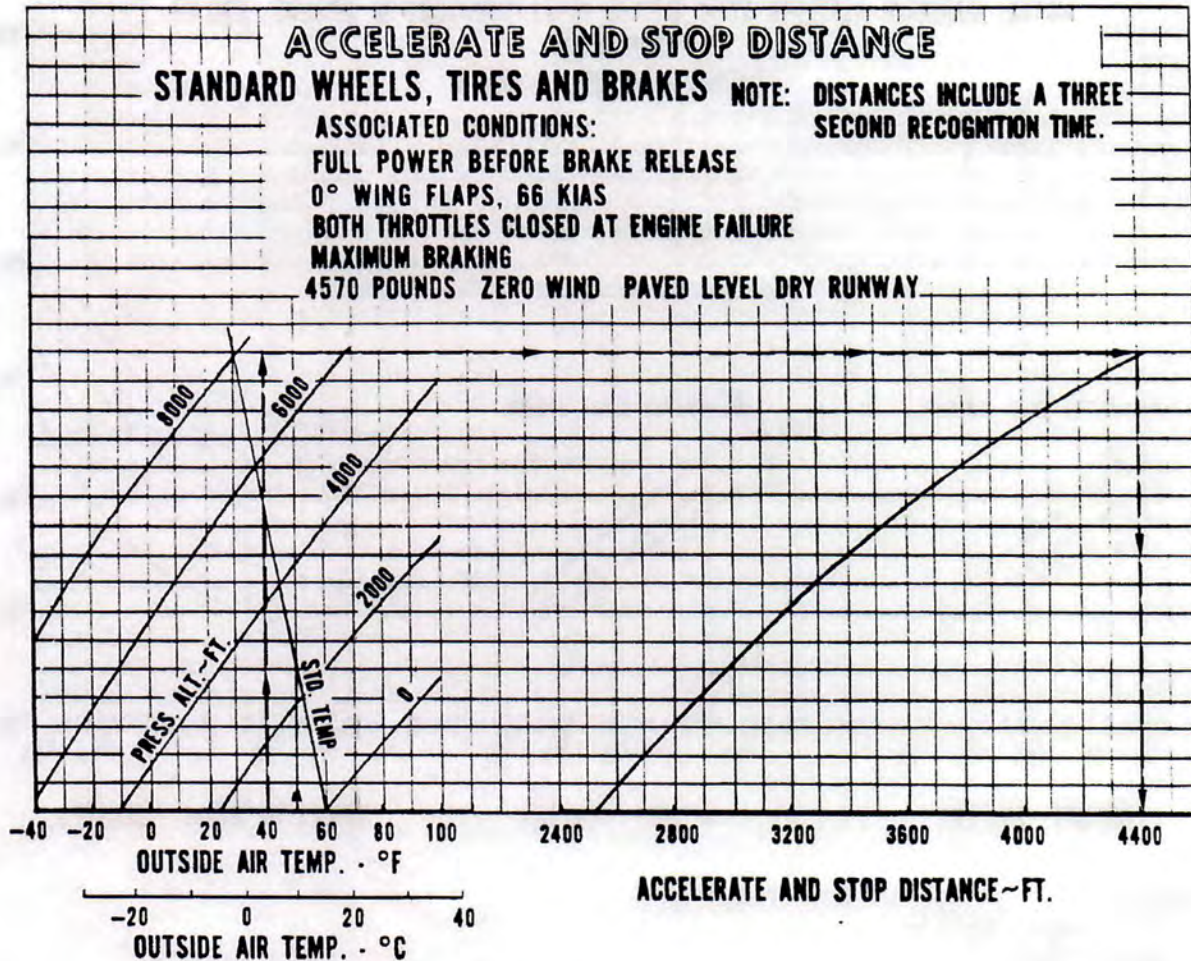

Example:  
 OAT: 40°F  
 Pressure altitude: 7586 ft.  
 Accelerate and stop distance: 4400 ft.

**ACCELERATE AND STOP DISTANCE (STANDARD)**

Figure 5-7

# PA-34-200T

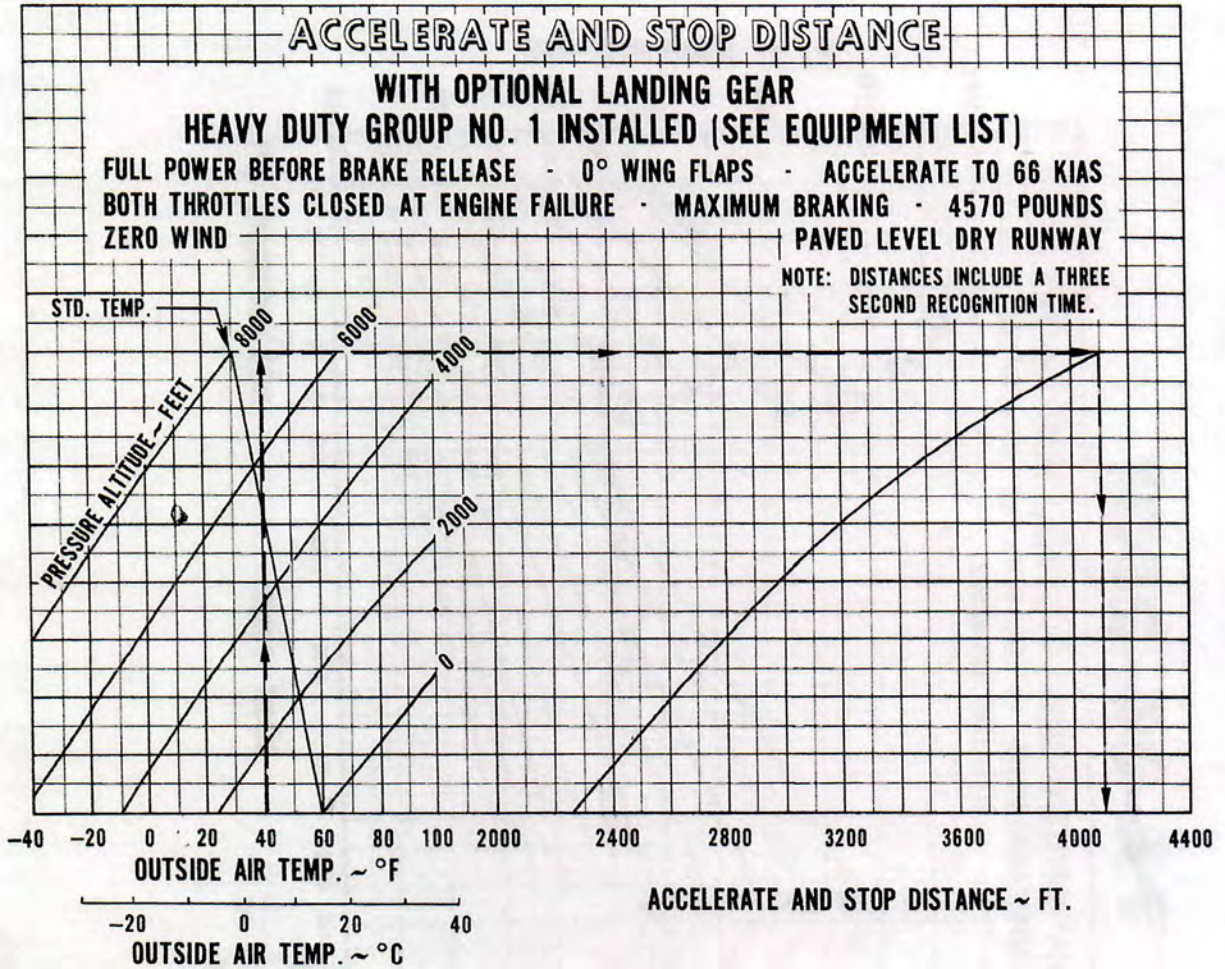

Example:  
OAT: 40°F  
Pressure altitude: 7586 ft.  
Accelerate and stop distance: 4100 ft.

ACCELERATE AND STOP DISTANCE (HEAVY DUTY GROUP 1)

Figure 5-9

# PA-34-200T

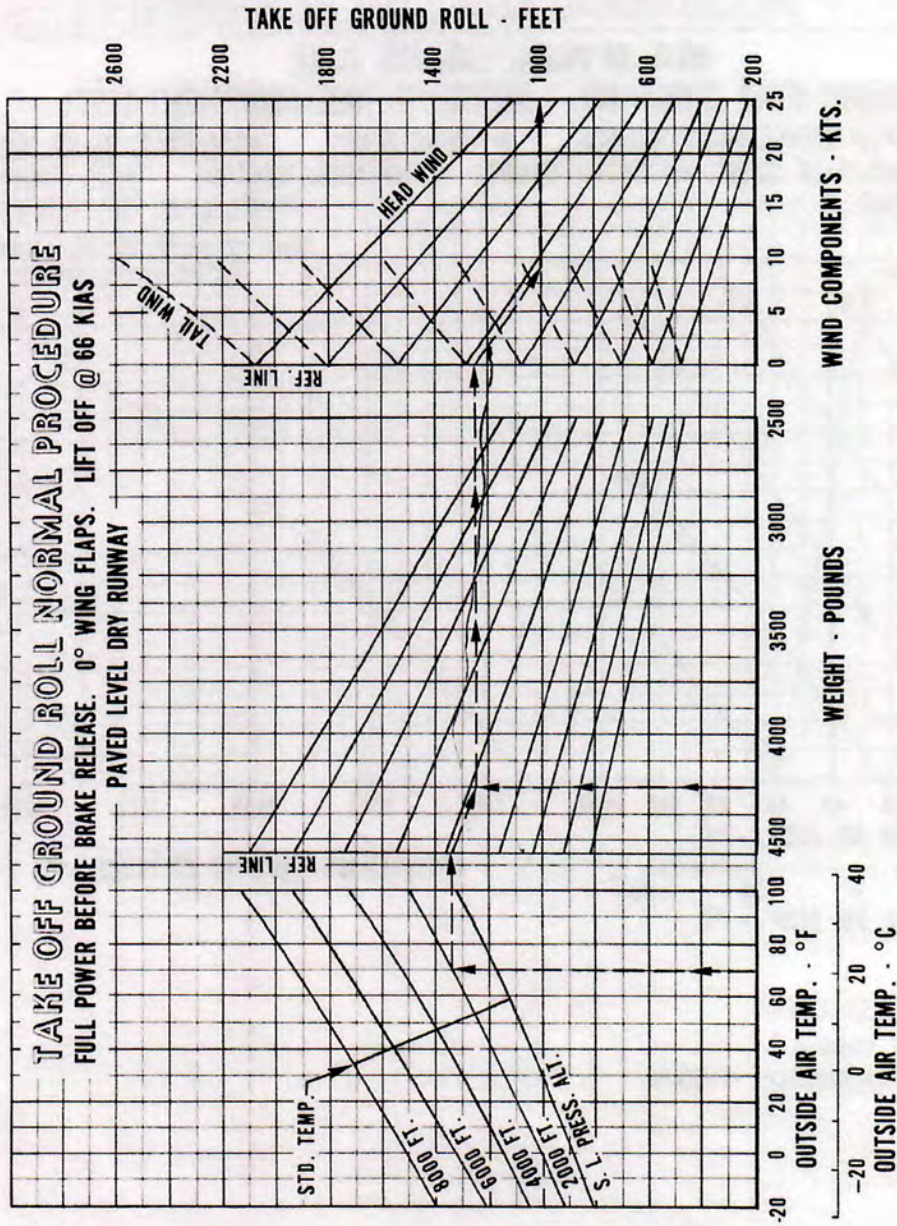

Example:  
 OAT: 70°F  
 Pressure altitude: 2000 ft.  
 Gross weight: 4250 lbs.  
 Headwind: 9 knots  
 Takeoff ground roll: 1000 ft.

TAKEOFF GROUND ROLL - NORMAL PROCEDURE

Figure 5-11

# PA-34-200T

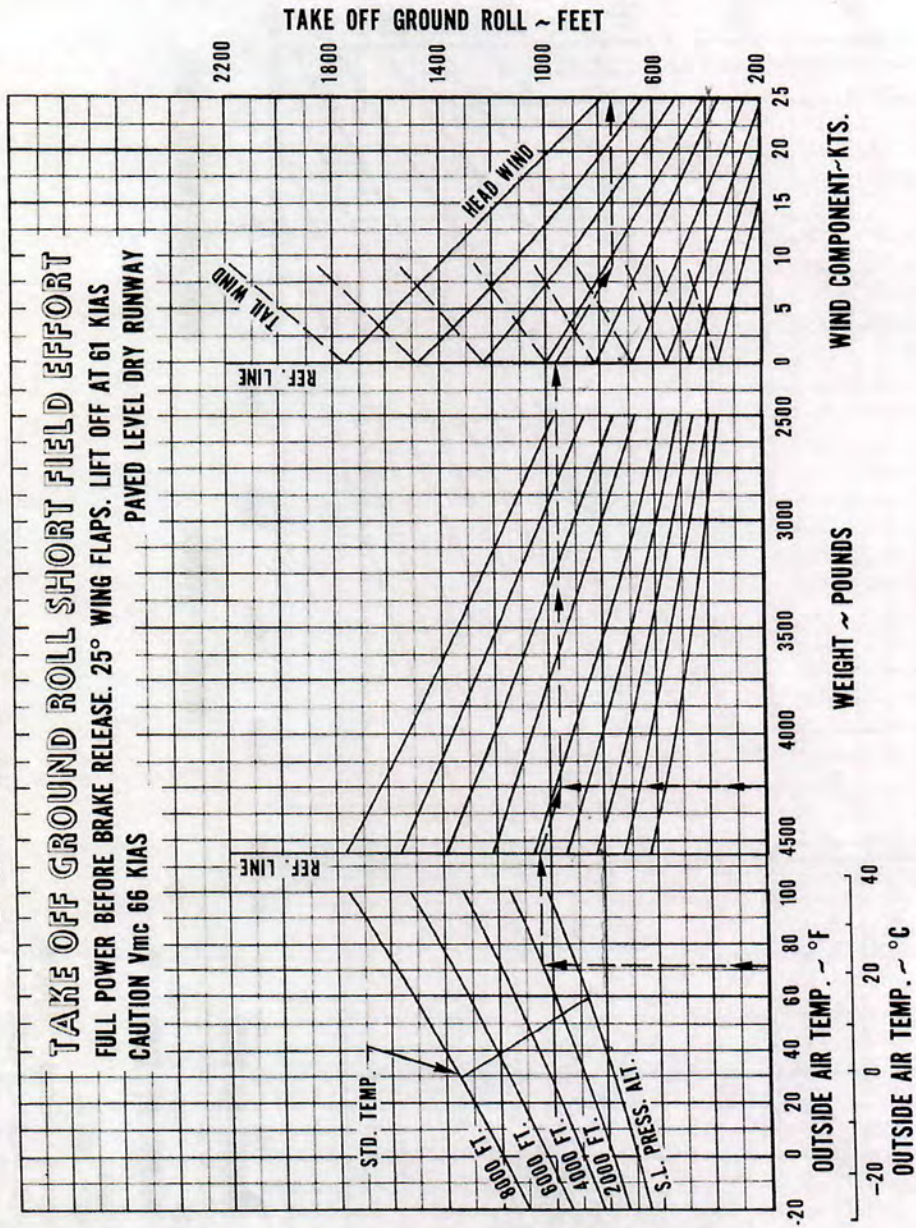

Example:  
 OAT: 70°F  
 Pressure altitude: 2000 ft.  
 Gross weight: 4250 lbs.  
 Headwind: 9 knots  
 Takeoff ground roll: 750 ft.

TAKEOFF GROUND ROLL - SHORT FIELD EFFORT

Figure 5-13

# PA-34-200T

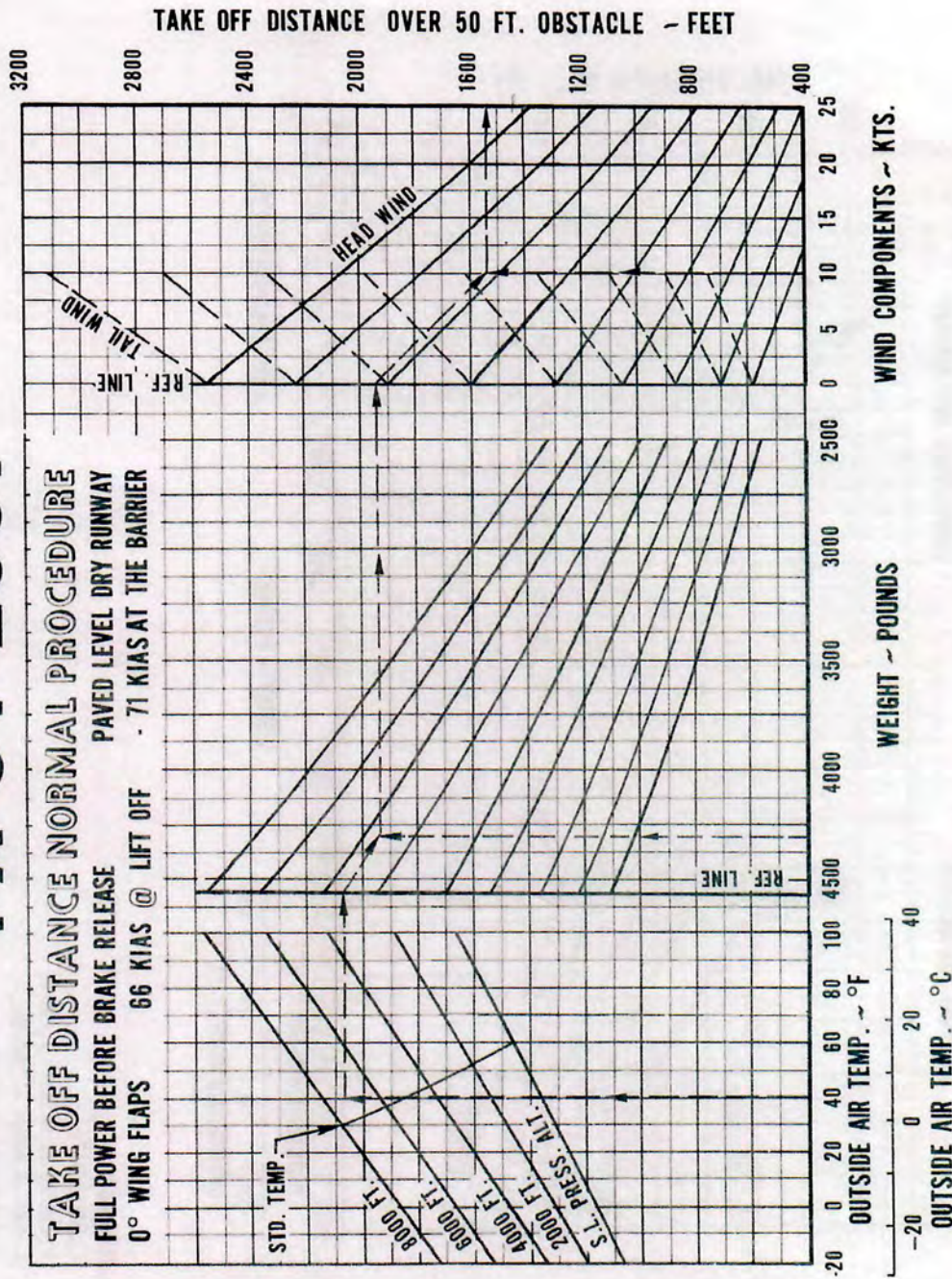

Example:  
 OAT: 40°F  
 Pressure altitude: 7586 ft.  
 Gross weight: 4290 lbs.  
 Headwind: 10 knots  
 Takeoff distance over 50 ft. obstacle: 1540 ft.

TAKEOFF DISTANCE - NORMAL PROCEDURE

Figure 5-15

# PA-34-200T

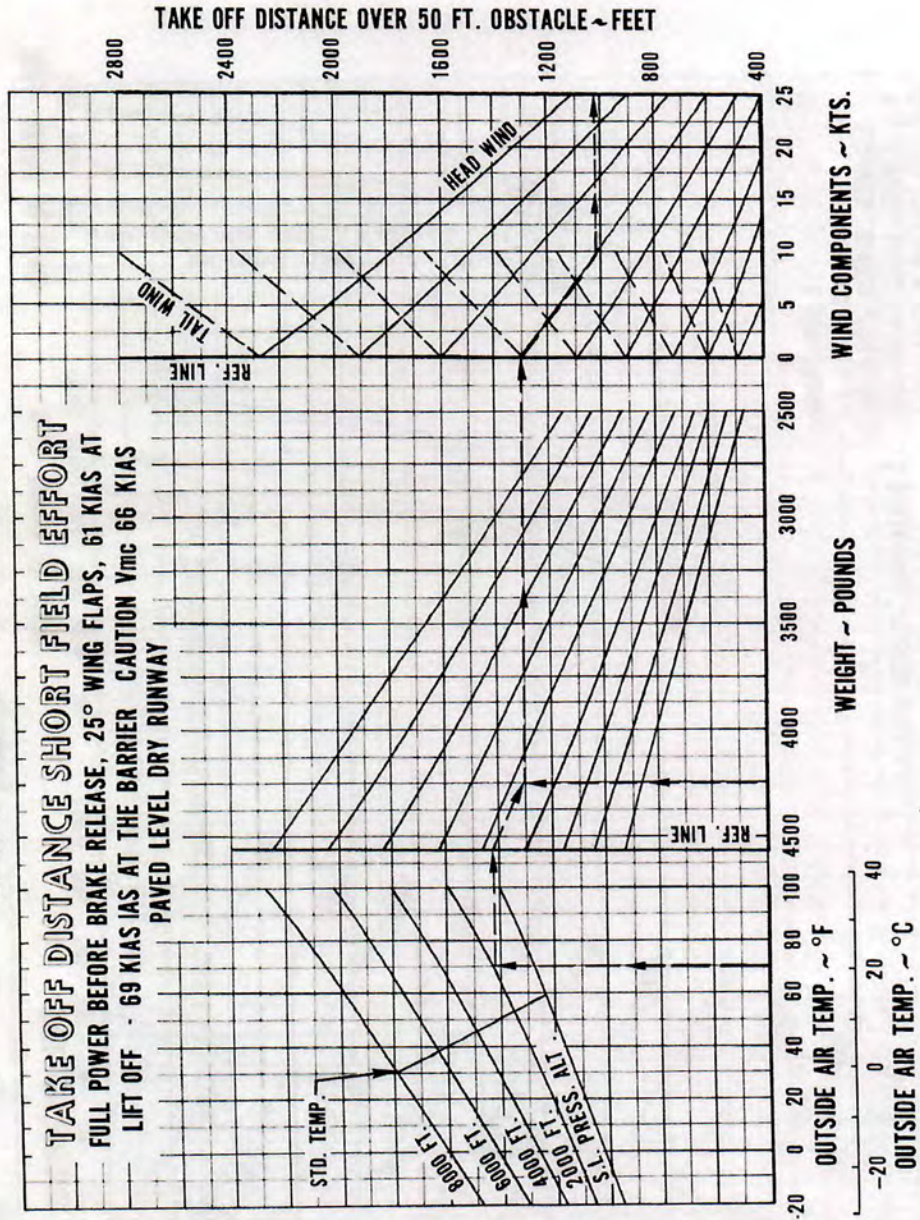

Example:  
 OAT: 70°F  
 Pressure altitude: 2000 ft.  
 Gross weight: 4250 lbs.  
 Headwind: 9 knots  
 Takeoff distance over 50 ft. obstacle: 1030 ft.

TAKEOFF DISTANCE - SHORT FIELD EFFORT

Figure 5-17

# PA-34-200T

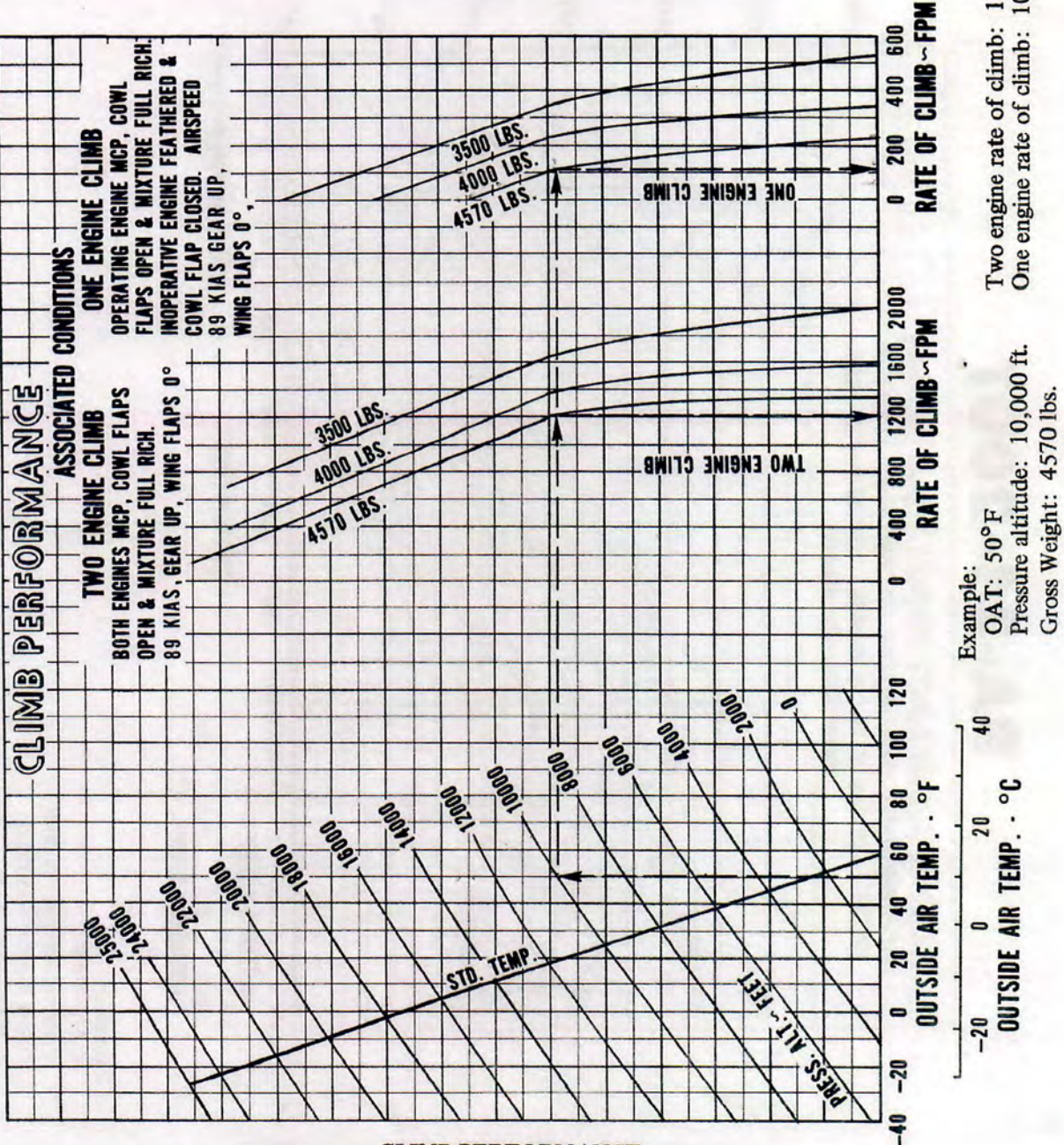

CLIMB PERFORMANCE

Figure 5-19



# PA-34-200T

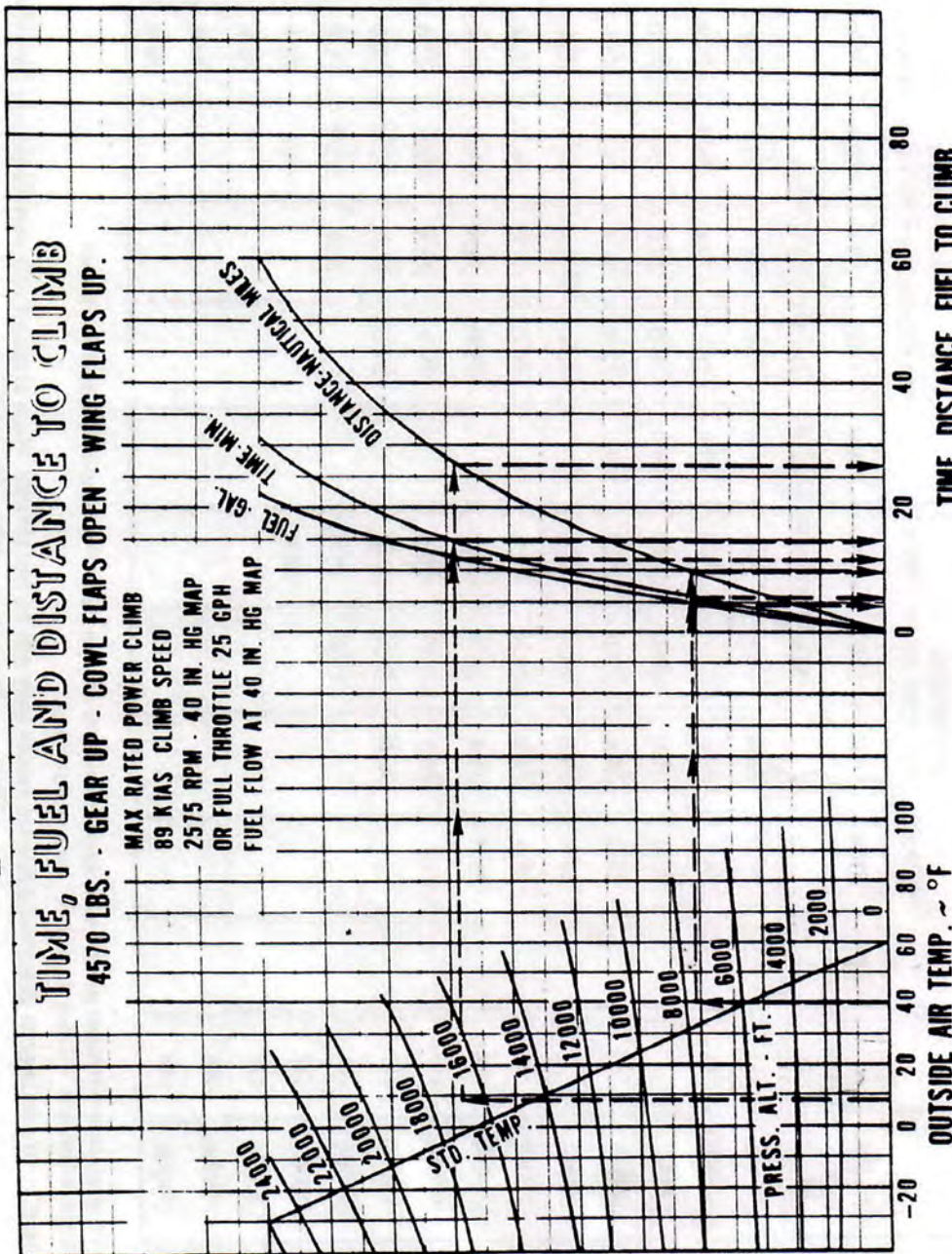

**Example:**  
Takeoff pressure altitude: 7586 ft. Cruise OAT: 8°F  
Takeoff OAT: 40°F  
Cruise pressure altitude: 16,500 ft. Power: Maximum power climb  
Time to climb: (15 minus 6) = 9 min  
Fuel to climb: (12 minus 4) = 8 gal.  
Distance to climb: (26 minus 10) = 16 nautical miles.

TIME, FUEL AND DISTANCE TO CLIMB

Figure 5-21

POWER SETTING TABLE -- T.C.M. TSIO 360E SERIES

PRESS. ALT. FEET	STD. ALT. TEMP. °C	45% POWER (APPROX. 16.1 GPH FUEL CONS.)					55% POWER (APPROX. 18 GPH FUEL CONS.)				
		RPM	2000	2100	2200	2300	2000	2200	2300	2400	2500
MANIFOLD PRESSURE: INCHES MERCURY											
S.L.	15	27.6	26.4	25.6	24.6	31.8	29.6	28.4	27.0	26.0	25.6
2000	11	26.8	25.6	25.0	24.0	30.8	28.5	27.6	26.4	25.4	25.0
4000	7	26.0	25.0	24.0	23.4	29.8	28.0	27.0	25.8	25.0	24.6
6000	3	25.0	24.4	23.6	22.8	29.0	27.4	26.4	25.2	24.4	24.0
8000	-1	24.6	23.6	22.8	22.3		26.6	25.6	24.8	24.0	23.8
10000	-5	23.8	23.0	22.4	21.8		26.0	25.0	24.2	23.6	23.2
12000	-9	23.0	22.4	21.7	21.0		25.0	24.4	23.8	23.0	22.8
14000	-13	22.6	21.8	21.0	20.6		24.5	23.8	23.0	22.6	22.4
16000	-17		21.0	20.4	20.0		24.0	23.4	22.6	22.0	22.0
18000	-21			19.8	19.4			22.8	22.0	21.0	21.7
20000	-25				18.8				21.6	20.8	21.0
22000	-28									20.6	20.8
24000	-33									20.4	20.4
25000	-34									20.0	20.0

POWER SETTING TABLE (45% AND 55%)

Figure 5-23

To maintain constant power, add approximately 1% for each 6°C above standard, subtract

approximately 1% for each 6°C below standard.

NOTE: Full throttle manifold pressure values may not be obtainable when atmospheric conditions are non-standard.

POWER SETTING TABLE T.C.M. TSIO 360F SERIES

PRESS. ALT. FEET	STD. ALT. TEMP. °C	RPM	65% POWER (APPROX. 20.5 GPH FUEL CONS.)					75% POWER (APPROX. 23.6 GPH FUEL CONS.)				
			2200	2300	2400	2500	2575	2300	2400	2500	2575	
MANIFOLD PRESSURE INCHES MERCURY												
S.L.	15		33.5	32.0	30.6	29.8	29.2	35.5	34.0	33.0	32.8	
2000	11		32.8	31.5	30.0	29.0	28.8	35.0	33.4	32.6	32.0	
4000	7		32.0	30.8	29.6	28.6	28.2	34.4	32.8	32.0	31.6	
6000	3		31.4	30.0	29.0	28.0	27.8	33.6	32.0	31.4	30.9	
8000	-1		30.6	29.6	28.4	27.6	27.4	33.0	31.6	30.8	30.3	
10000	-5			28.8	27.8	27.0	27.0	32.4	31.0	30.2	29.8	
12000	-9			28.0	27.2	26.6	26.4	31.6	30.4	29.8	29.3	
14000	-13			27.4	26.6	26.0	26.0		29.8	29.2	29.0	
16000	-17			26.7	26.0	25.8	25.6		29.4	28.8	28.6	
18000	-21				25.6	25.2	25.0			28.4	28.3	
20000	-25					24.8	24.8					
22000	-28					24.4	24.4					
24000	-33						24.0					
25000	-34											

To maintain constant power, add approximately 1% for each 6°C above standard, subtract approximately 1% for each 6°C below standard.

NOTE: Full throttle manifold pressure values may not be obtainable when atmospheric conditions are non-standard.

POWER SETTING TABLE (65% AND 75%)

Figure 5-25

## NON-STANDARD TEMPERATURE RANGE WITH MAXIMUM POWER CLIMB

USABLE FUEL 93 GALLONS · 4570 LBS. · MIXTURE LEANED 25° RICH OF PEAK DURING CRUISE  
GEAR UP · COWL FLAPS CLOSED · WING FLAPS UP · CLIMB AT M.C.P.  
DESCENT AT 1000 FPM AND 129 KIAS - NO WIND  
4.2 GAL. FUEL FOR START, TAXI AND T.O.

PRESS. ALT. FEET	O.A.T. °C	45 MIN RESERVE				NO RESERVE				
		POWER				POWER				
		75	65	55	45	75	65	55	45	
0	ISA + 30° C	-15	475	506	537	529	549	585	621	612
5000		-25	505	540	562	575	584	627	664	668
10,000		-35	526	564	593	607	613	657	693	708
15,000		-45	533	574	599	613	625	673	703	720
20,000		-55	539	575	596	606	635	679	704	716
25,000		-65		576	590	595		682	700	703
0	ISA + 15° C	0	491	526	558	555	568	608	646	642
5000		-10	520	558	590	598	604	648	685	695
10,000		-20	537	577	606	623	626	673	708	727
15,000		-30	542	584	607	620	636	685	713	728
20,000		-40	548	582	602	612	646	687	711	723
25,000		-50		580	597	606		686	703	715
0	ISA - 15° C	30	521	561	594	600	603	649	688	694
5000		20	544	585	617	632	634	680	716	734
10,000		10	553	598	623	638	645	697	728	745
15,000		0	560	598	620	632	657	702	728	742
20,000		-10								
25,000		-20								
0	ISA -30° C	45	536	576	610	619	620	667	706	716
5000		35	553	596	627	643	642	692	728	748
10,000		25	561	605	630	644	655	706	736	752
15,000		15	567	604	626	635	665	709	735	747
20,000		5								
25,000		-5								

NON-STANDARD TEMPERATURE RANGE WITH  
MAXIMUM POWER CLIMB (93 USABLE GAL.)

Figure 5-26

# PA-34-200T

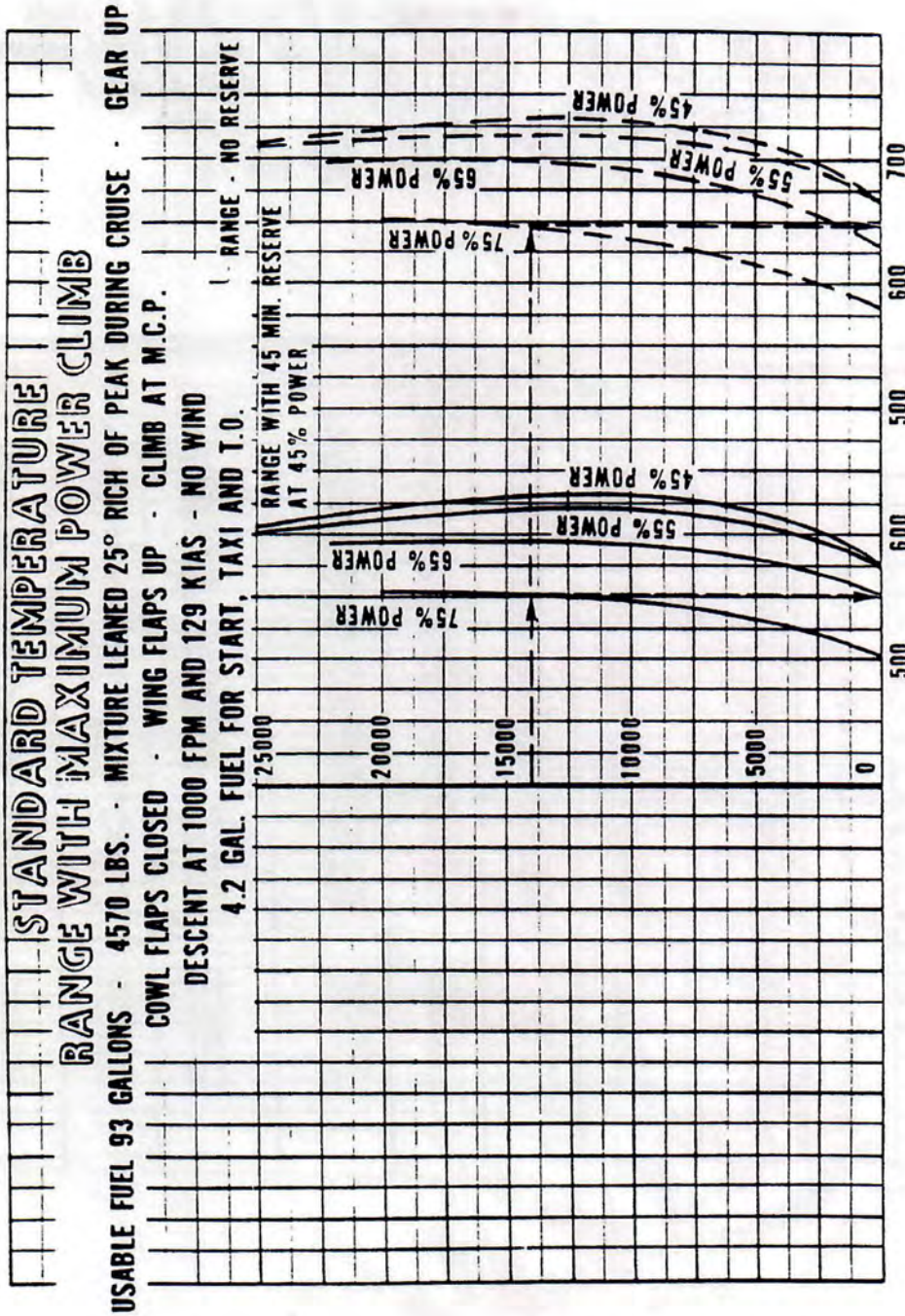

STANDARD TEMPERATURE RANGE WITH MAXIMUM POWER CLIMB (93 USABLE GAL.)

Figure 5-27

Example:  
Pressure altitude: 14,000 ft.  
Power: 75%  
Range (with reserve): 550 nautical miles  
Range (no reserve): 650 nautical miles

**NON-STANDARD TEMPERATURE  
RANGE WITH MAXIMUM POWER CLIMB**

USABLE FUEL 123 GALLONS - 4570 LBS. - MIXTURE LEANED 25° RICH OF PEAK DURING CRUISE  
GEAR UP - COWL FLAPS CLOSED - WING FLAPS UP - CLIMB AT M.C.P.  
DESCENT AT 1000 FPM AND 129 KIAS - NO WIND  
4.2 GAL. FUEL FOR START, TAXI AND T.O.

PRESS. ALT. FEET	O.A.T. °C	45 MIN RESERVE				NO RESERVE				
		% POWER				% POWER				
		75	65	55	45	75	65	55	45	
0	ISA + 30° C	-15	660	702	746	735	734	782	830	818
5000		-25	705	756	800	807	785	843	893	901
10,000		-35	742	797	840	859	829	891	939	961
15,000		-45	761	821	857	878	852	920	961	985
20,000		-55	778	832	864	880	874	936	971	990
25,000		-65		835	860	874		941	970	988
0	ISA + 15° C	0	682	731	775	771	759	813	863	858
5000		-10	728	782	827	838	812	870	921	934
10,000		-20	759	816	858	882	848	912	960	987
15,000		-30	775	839	870	888	868	936	975	997
20,000		-40	792	843	874	888	890	948	983	999
25,000		-50		841	869	882		945	978	990
0	ISA - 15° C	30	724	780	826	833	806	868	919	927
5000		20	762	819	864	886	850	914	964	989
10,000		10	781	846	883	904	873	945	987	1011
15,000		0	800	857	889	905	897	960	998	1016
20,000		-10								
25,000		-20								
0	ISA -30° C	-45	745	801	848	860	829	891	943	957
5000		35	774	835	879	903	864	930	980	1007
10,000		25	793	857	892	912	887	958	998	1021
15,000		15	812	866	897	912	910	970	1007	1024
20,000		15								
25,000		-5								

NON-STANDARD TEMPERATURE RANGE WITH  
MAXIMUM POWER CLIMB (123 USABLE GAL.)  
Figure 5-28

# PA-34-200T

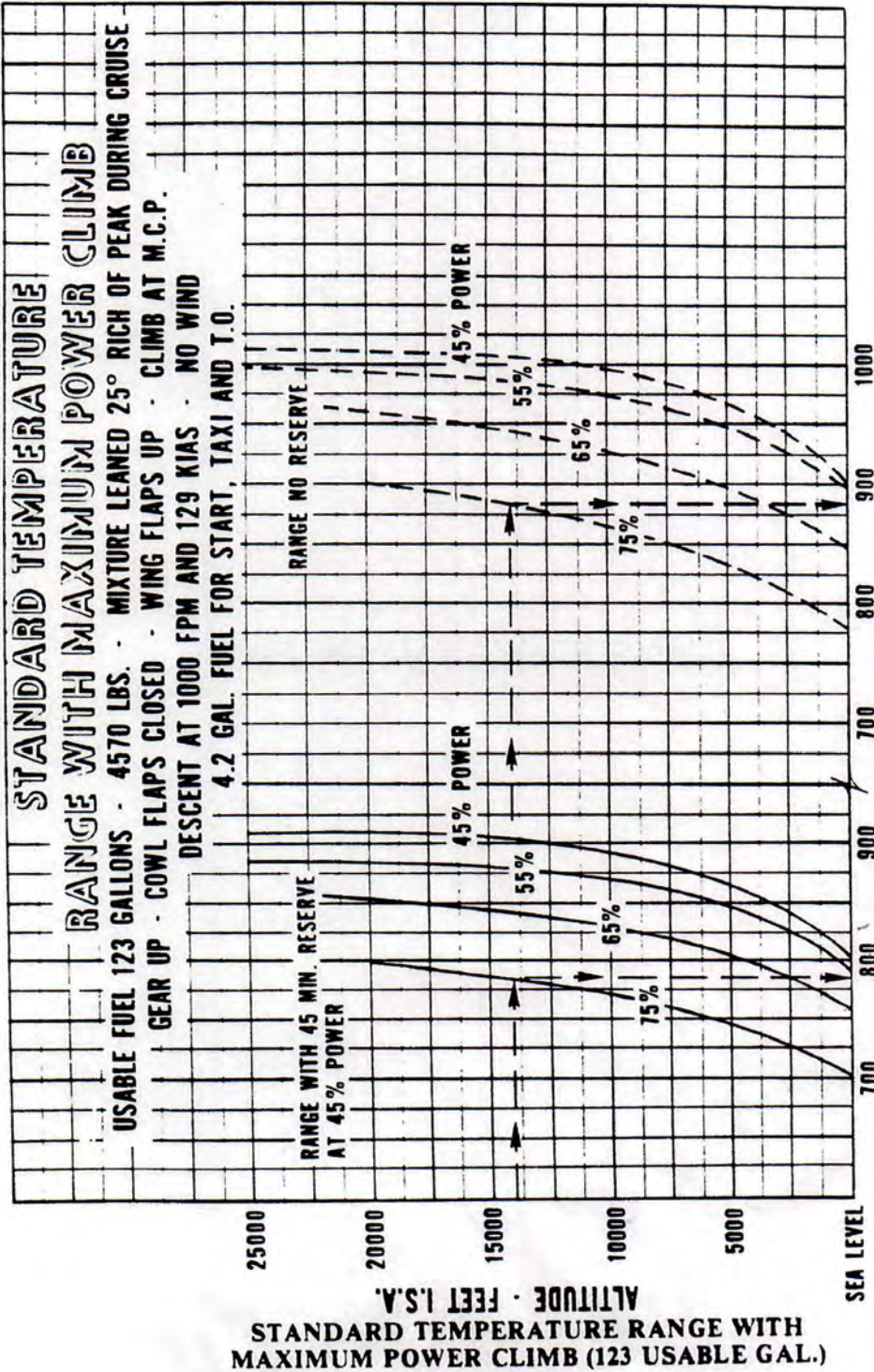

Example:  
 Pressure altitude: 14,000 ft.  
 Power: 75%  
 Range (with reserve): 785 nautical miles  
 Range (no reserve): 880 nautical miles

Figure 5-29

THIS PAGE INTENTIONALLY LEFT BLANK



# PA-34-200T

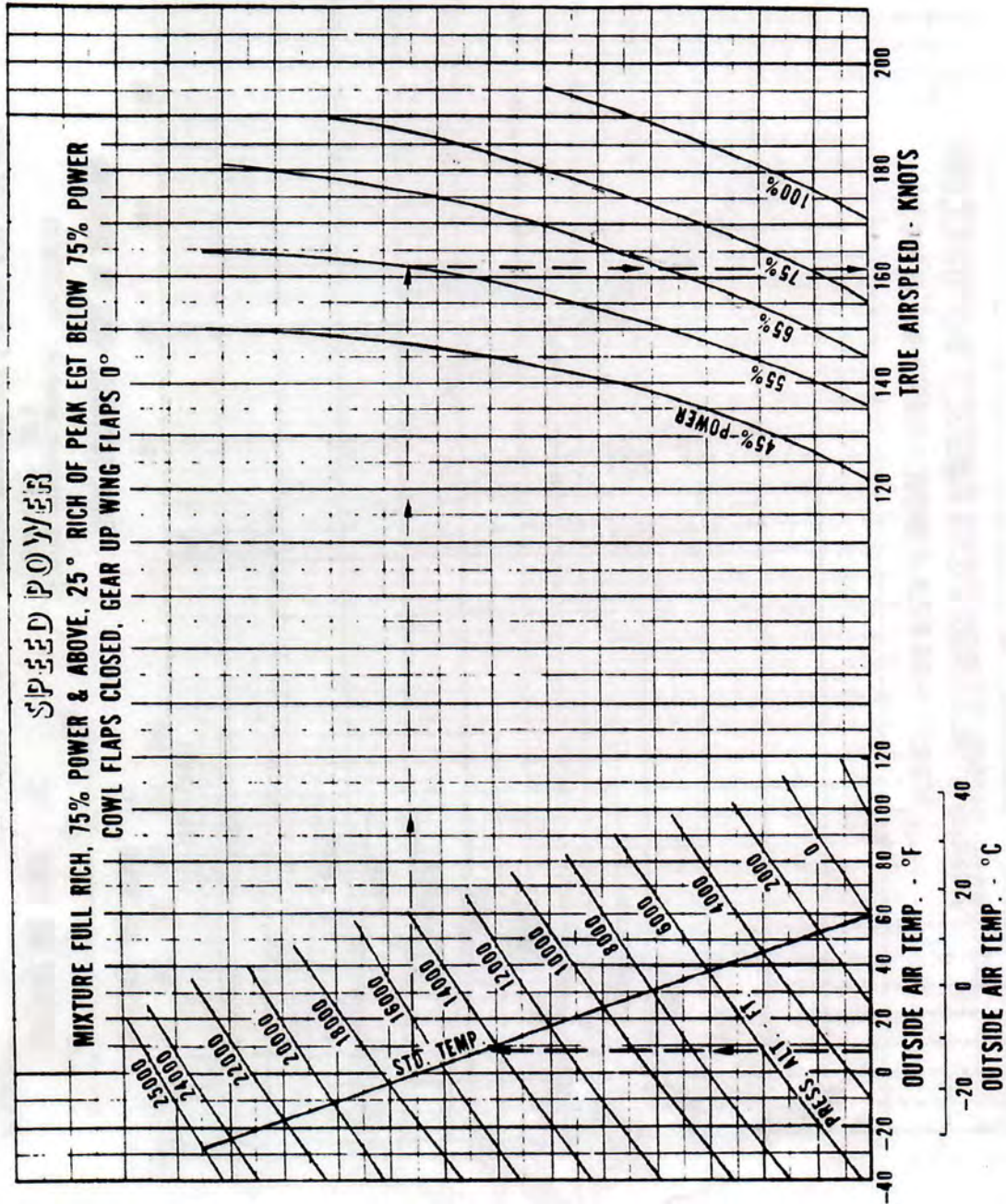

**SPEED POWER**

Figure 5-31

# PA-34-200T

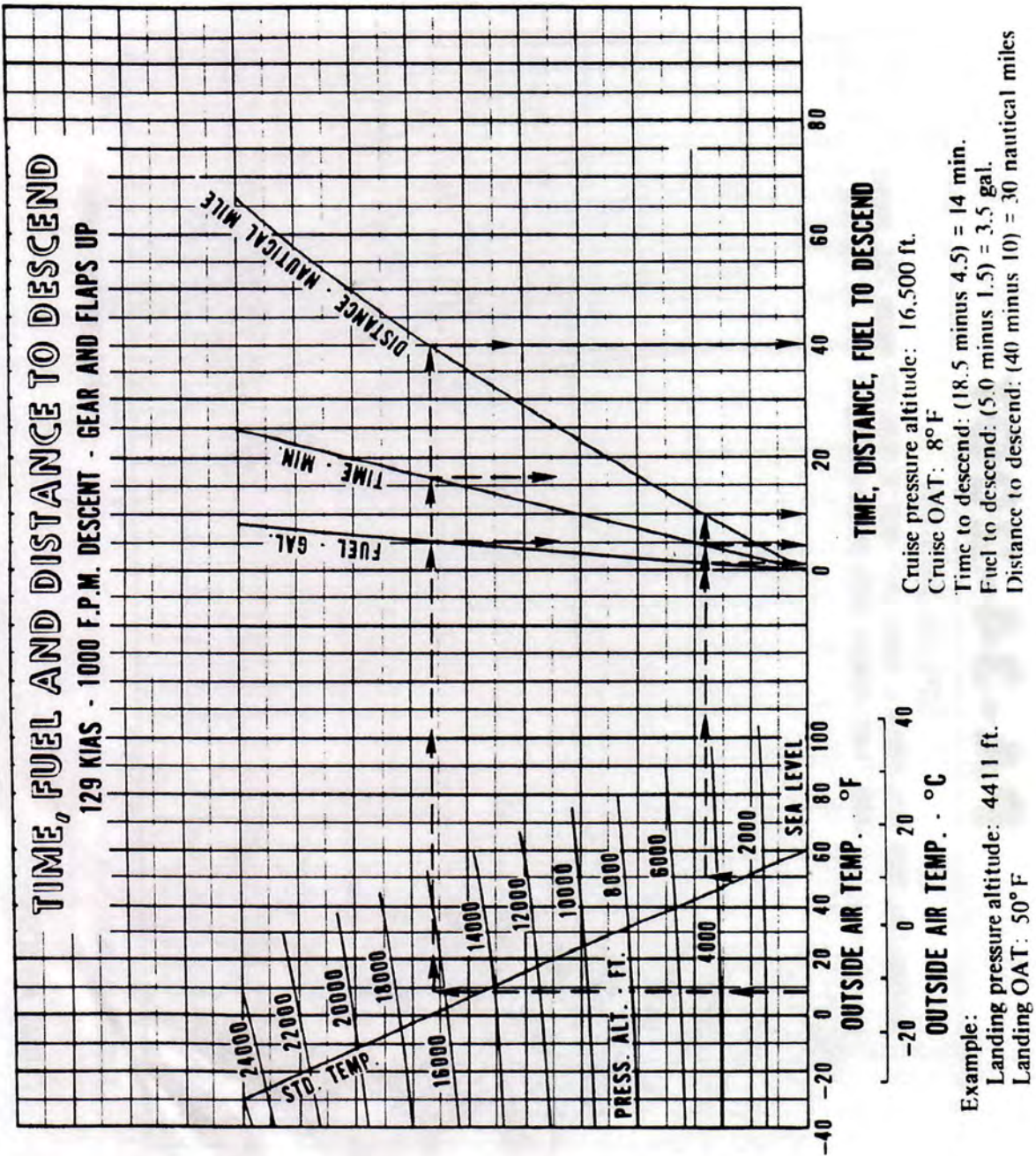

TIME, FUEL AND DISTANCE TO DESCEND

Figure 5-33

# PA-34-200T

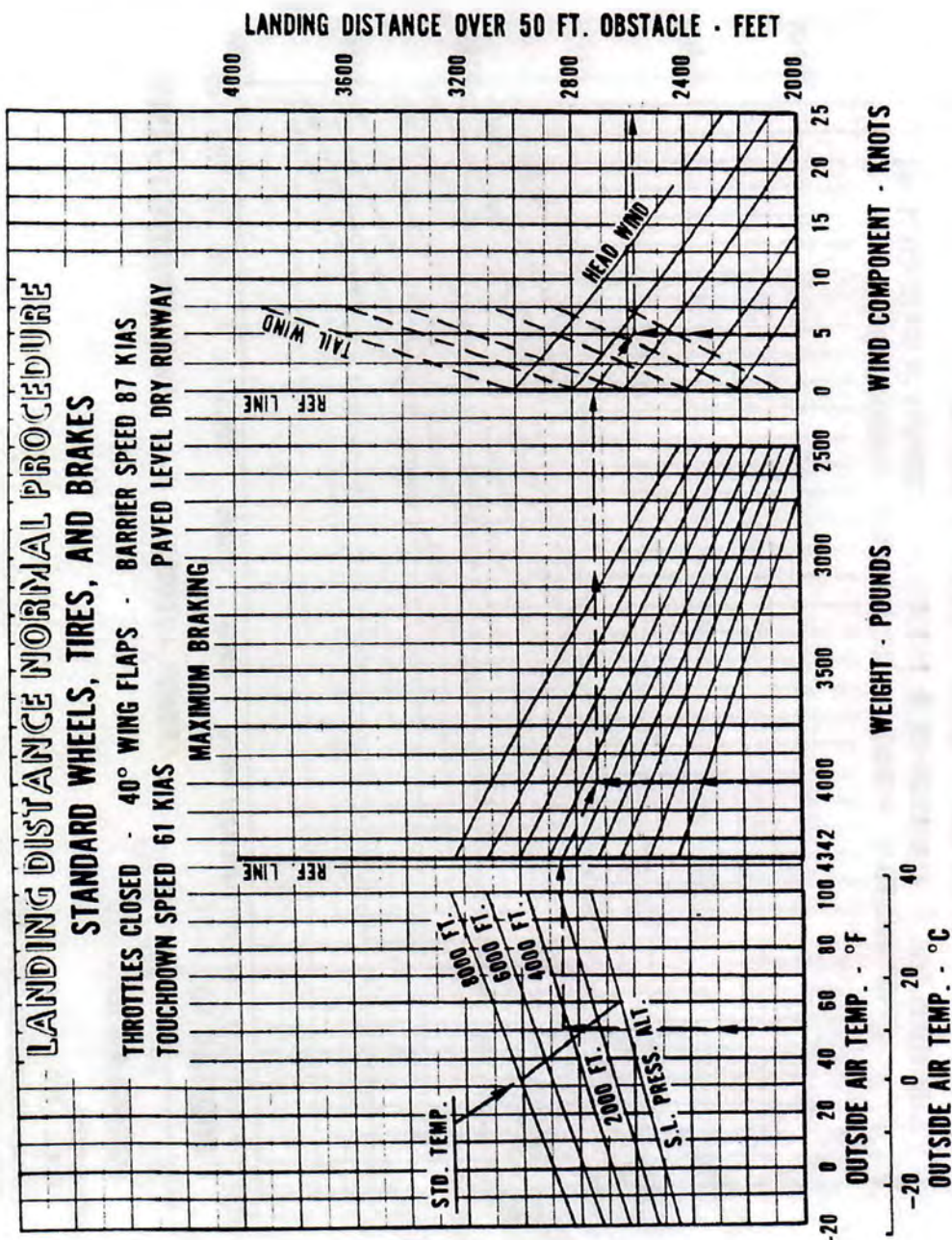

Example:  
OAT: 50°F  
Pressure altitude: 4411 ft.  
Gross weight: 4006 lbs.  
Headwind: 5 knots  
Landing distance over 50 ft. obstacle: 2590 ft.

LANDING DISTANCE - NORMAL PROCEDURE (STANDARD)

Figure 5-35

# PA-34-200T

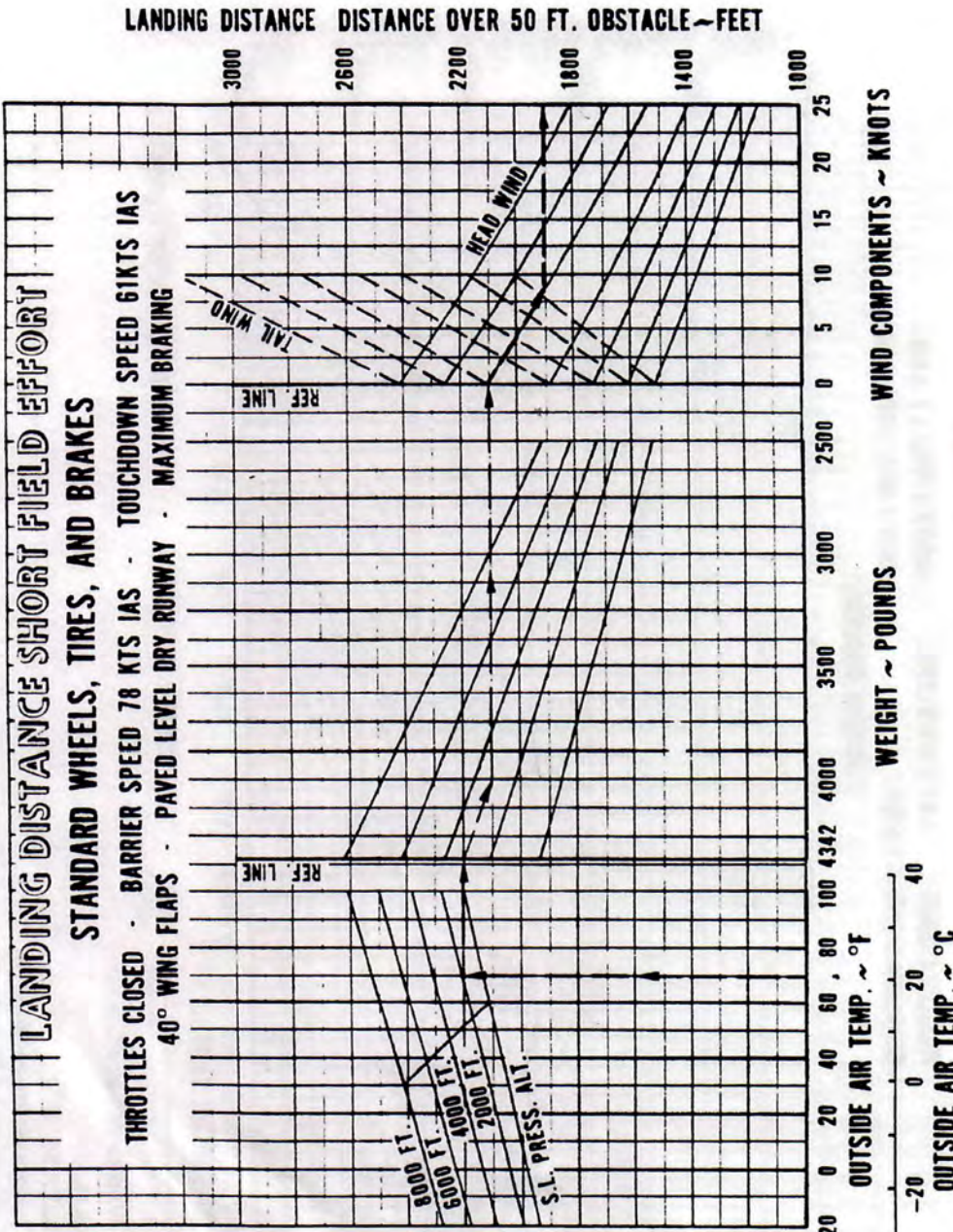

Example:  
 OAT: 70°F  
 Pressure altitude: 2000 ft.  
 Gross weight: 4000 lbs.  
 Headwind: 9 knots  
 Landing distance over 50 ft. obstacle: 1920 ft.

LANDING DISTANCE - SHORT FIELD EFFORT (STANDARD)

Figure 5-37

# PA-34-200T

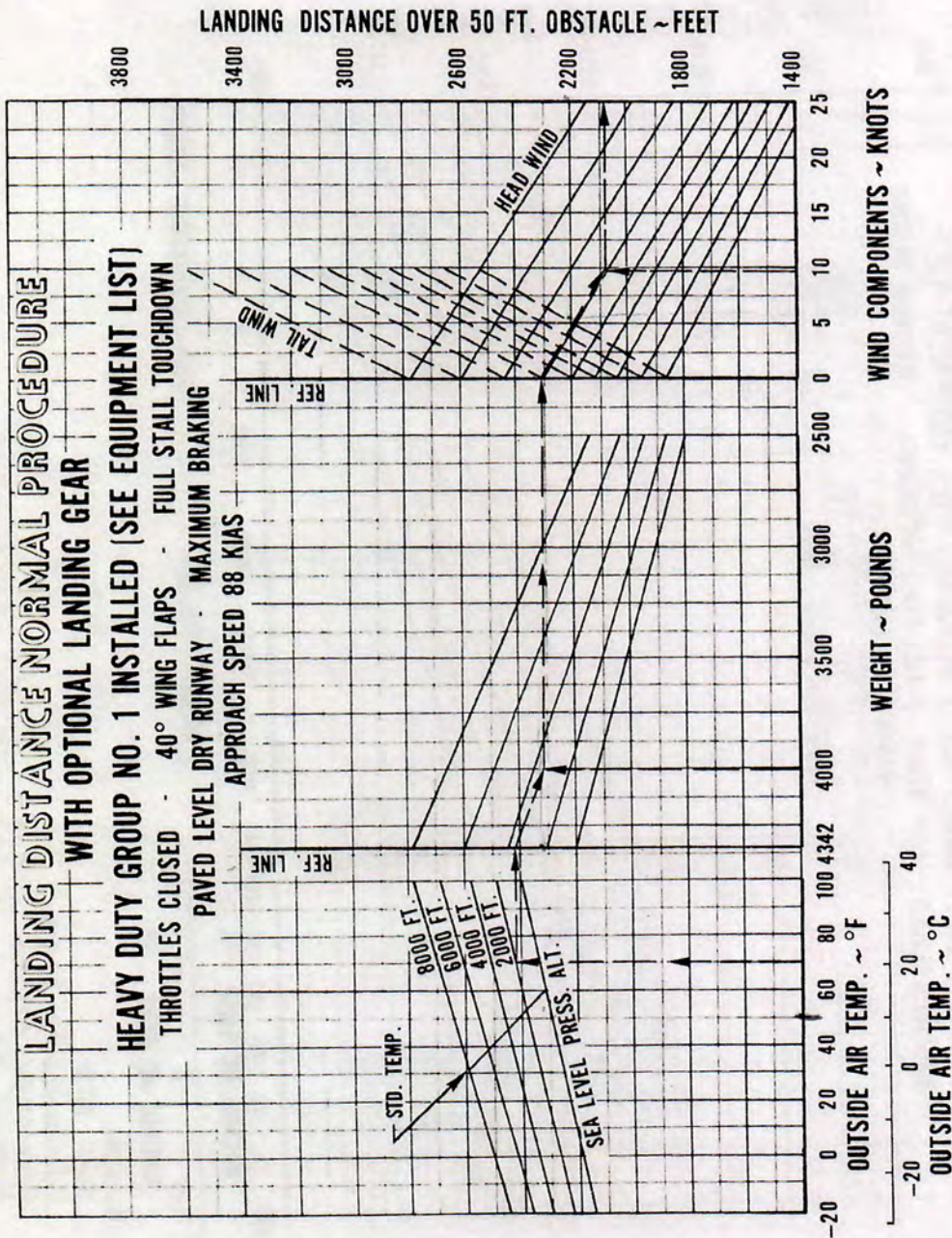

Example:  
 OAT: 70°F  
 Pressure altitude: 2000 ft.  
 Gross weight: 4000 lbs.  
 Headwind: 9 knots  
 Landing distance over 50 ft. obstacle: 2090 ft.

LANDING DISTANCE - NORMAL PROCEDURE (HEAVY DUTY GROUP 1)

Figure 5-39

# PA-34-200T

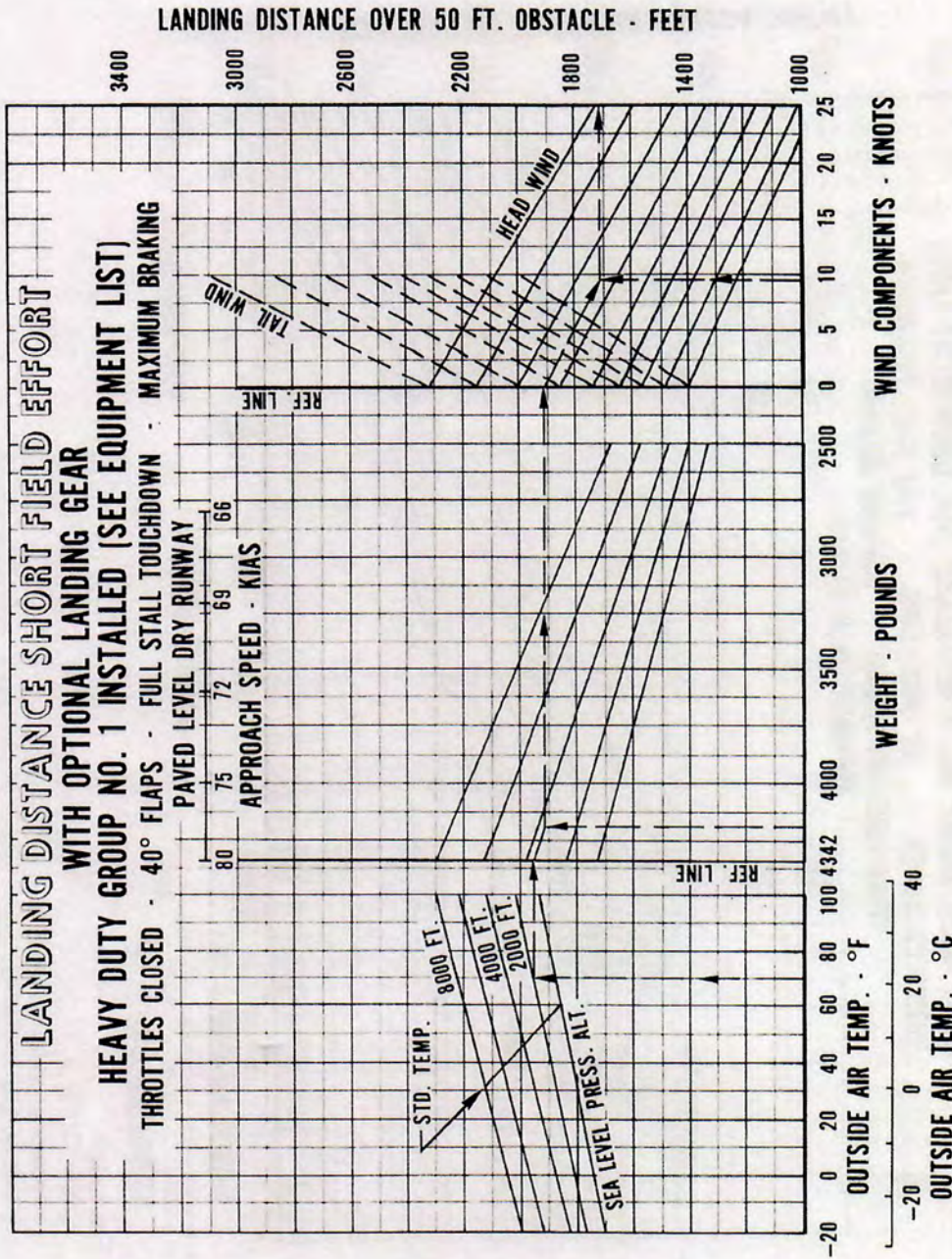

Example:  
 OAT: 70°F  
 Pressure altitude: 2000 ft.  
 Gross weight: 4190 lbs.  
 Headwind: 9 knots  
 Landing distance over 50 ft. obstacle: 1720 ft.

LANDING DISTANCE - SHORT FIELD EFFORT (HEAVY DUTY GROUP 1)

Figure 5-41

# PA-34-200T

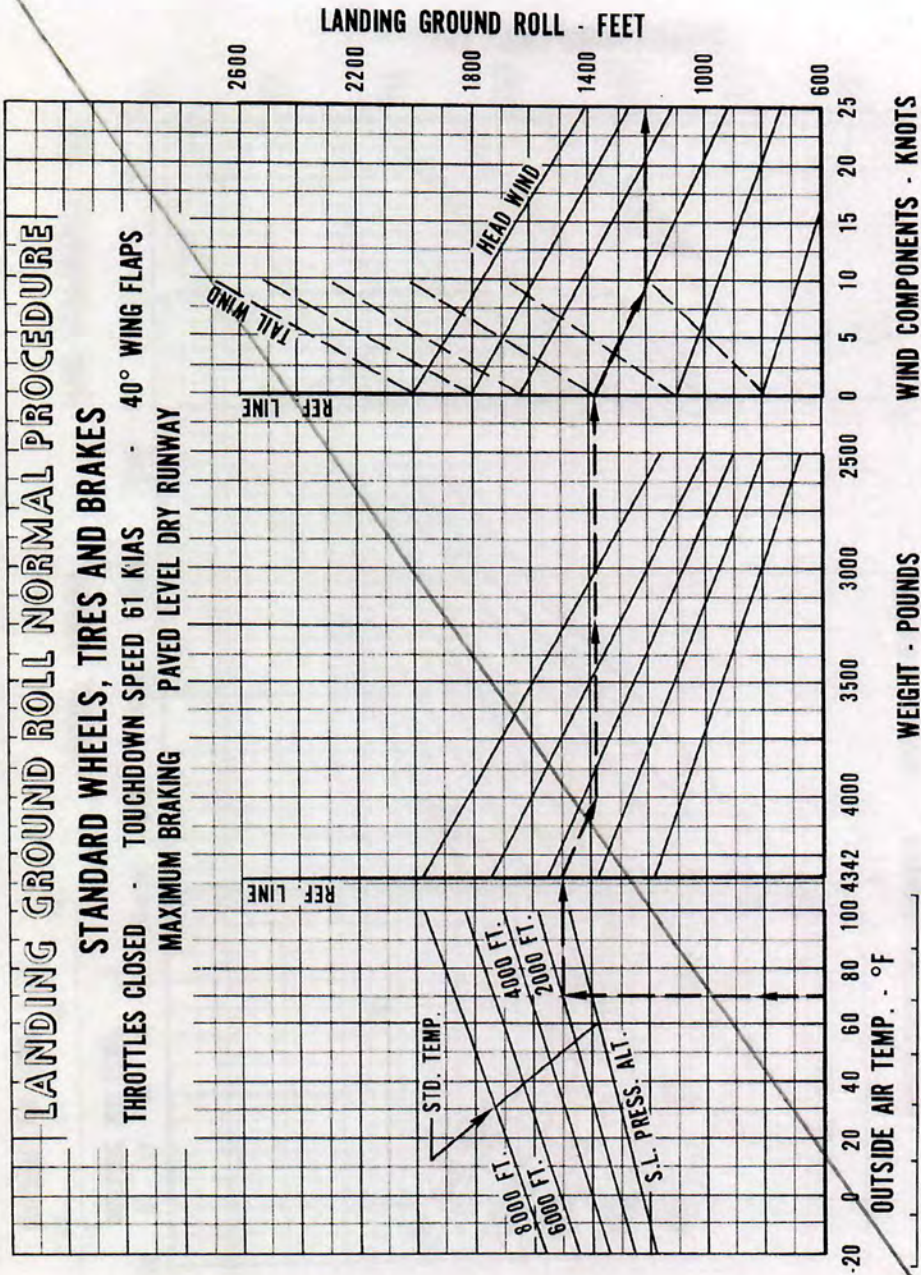

Example:  
 OAT: 70°F  
 Pressure altitude: 2000 ft.  
 Gross weight: 4000 lbs.  
 Headwind: 9 knots  
 Landing ground roll: 1200 ft.

LANDING GROUND ROLL - NORMAL PROCEDURE (STANDARD)

Figure 5-43

# PA-34-200T

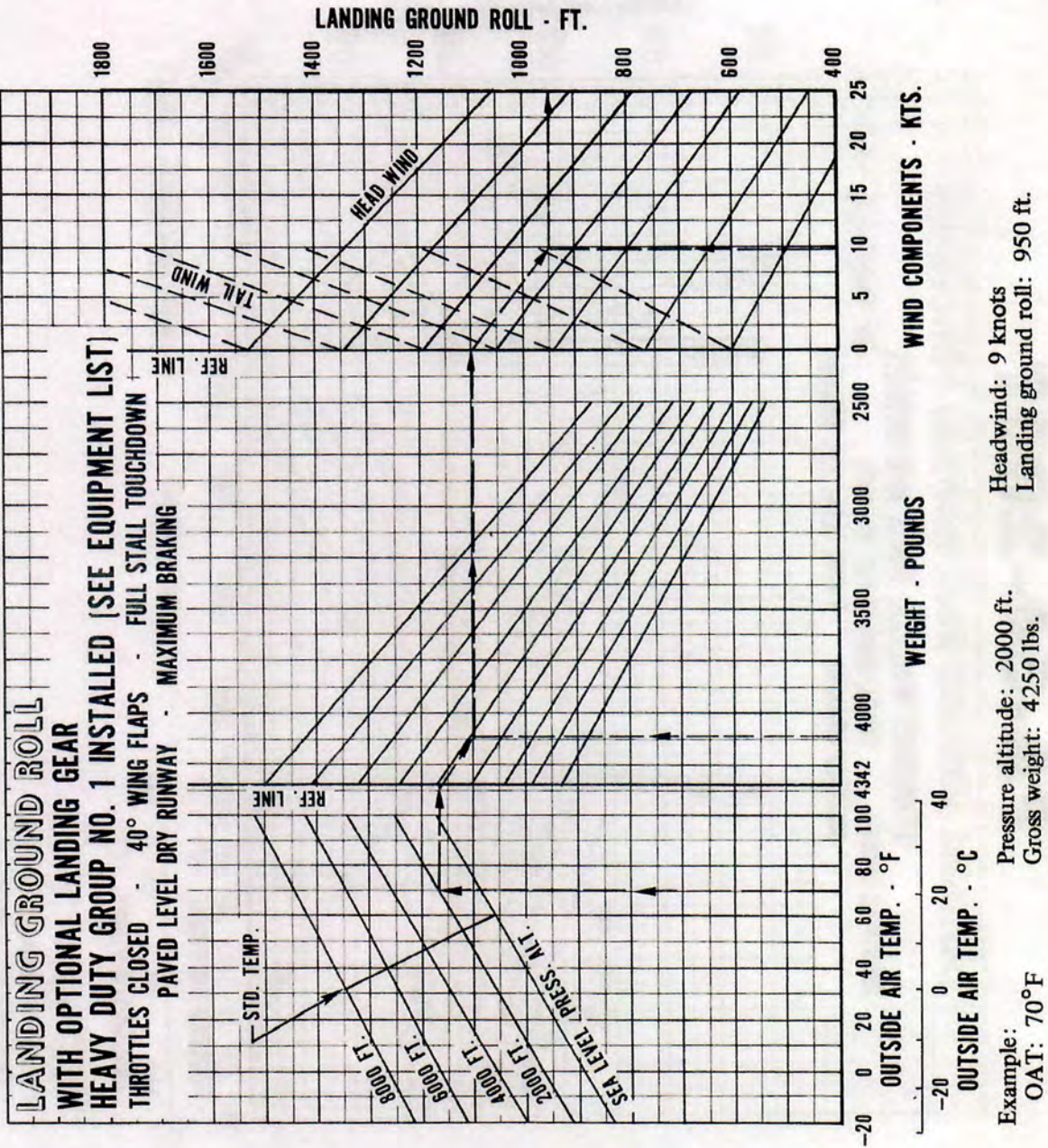

LANDING GROUND ROLL (HEAVY DUTY GROUP 1)

Figure 5-45



**TABLE OF CONTENTS**  
**SECTION 6**  
**WEIGHT AND BALANCE**

Paragraph No.		Page No.
6.1	General .....	6-1
6.3	Airplane Weighing Procedure .....	6-3
6.5	Weight and Balance Data and Record .....	6-6
6.6	General Loading Recommendations .....	6-10a
6.7	Weight and Balance Determination for Flight .....	6-11
6.8	Instruction for Using the Weight and Balance Plotter .....	6-15
6.9	Equipment List .....	6-17
	(a) Propeller and Propeller Accessories .....	6-17
	(b) Engine and Engine Accessories .....	6-19
	(c) Landing Gear and Brakes .....	6-21
	(d) Electrical Equipment .....	6-23
	(e) Instruments .....	6-25
	(f) Miscellaneous .....	6-27
	(g) Engine and Engine Accessories (Optional Equipment) .....	6-29
	(h) Propeller and Propeller Accessories (Optional Equipment) .....	6-31
	(i) Landing Gear and Brakes (Optional Equipment) .....	6-33
	(j) Electrical Equipment (Optional Equipment) .....	6-35
	(k) Instruments (Optional Equipment) .....	6-37
	(l) Autopilots (Optional Equipment) .....	6-41
	(m) Radio Equipment (Optional Equipment) .....	6-42a
	(n) Miscellaneous (Optional Equipment) .....	6-55
	(o) Maximum Zero Fuel Weight Increase .....	6-61

STATE OF TEXAS  
COUNTY OF [illegible]  
[illegible]

[illegible text]

[illegible text]

[illegible text]



SECTION 6  
WEIGHT AND BALANCE

6.1 GENERAL

In order to achieve the performance and flying characteristics which are designed into the airplane, it must be flown with the weight and center of gravity (C.G.) position within the approved operating range (envelope). Although the airplane offers flexibility of loading it cannot be flown with the maximum number of adult passengers, full fuel tanks and maximum baggage. With the flexibility comes responsibility. The pilot must ensure that the airplane is loaded within the loading envelope before he makes a takeoff.

Misloading carries consequences for any aircraft. An overloaded airplane will not take off, climb or cruise as well as a properly loaded one. The heavier the airplane is loaded, the less climb performance it will have.

Center of gravity is a determining factor in flight characteristics. If the C.G. is too far forward in any airplane, it may be difficult to rotate for takeoff or landing. If the C.G. is too far aft, the airplane may rotate prematurely on takeoff or tend to pitch up during climb. Longitudinal stability will be reduced. This can lead to inadvertent stalls and even spins; and spin recovery becomes more difficult as the center of gravity moves aft of the approved limit.

A properly loaded airplane, however, will perform as intended. Before the airplane is licensed, it is weighed, and a basic empty weight and C.G. location is computed (basic empty weight consists of the standard empty weight of the airplane plus the optional equipment). Using the basic empty weight and C.G. location, the pilot can easily determine the weight and C.G. position for the loaded airplane by computing the total weight and moment and then determining whether they are within the approved envelope.

The basic empty weight and C.G. location are recorded in the Weight and Balance Data Form (Figure 6-5) and the Weight and Balance Record (Figure 6-7). The current values should always be used. Whenever new equipment is added or any modification work is done, the mechanic responsible for the work is required to compute a new basic empty weight and C.G. position and to write these in the Aircraft Log Book and the Weight and Balance Record. The owner should make sure that it is done.

A weight and balance calculation is necessary in determining how much fuel or baggage can be boarded so as to keep the C.G. within allowable limits. Check calculations prior to adding fuel to ensure against improper loading.

The following pages are forms used in weighing an airplane and in computing basic empty weight, C.G. position, and useful load. Note that the useful load includes usable fuel, baggage, cargo and passengers. Following this is the method for computing takeoff weight and C.G.

THIS PAGE INTENTIONALLY LEFT BLANK

### **6.3 AIRPLANE WEIGHING PROCEDURES**

At the time of licensing, Piper Aircraft Corporation provides each airplane with the basic empty weight and center of gravity location. This data is supplied by Figure 6-5.

The removal or addition of equipment or airplane modifications can affect the basic empty weight and center of gravity. The following is a weighing procedure to determine this basic empty weight and center of gravity location:

**(a) Preparation**

- (1) Be certain that all items checked in the airplane equipment list are installed in the proper location in the airplane.
- (2) Remove excessive dirt, grease, moisture, foreign items such as rags and tools from the airplane before weighing.
- (3) Defuel airplane. Then open all fuel drains until all remaining fuel is drained. Operate each engine until all undrainable fuel is used and engine stops. Then add the unusable fuel (5.0 gallons total, 2.5 gallons each wing).
- (4) Fill with oil to full capacity.
- (5) Place pilot and copilot seats in fourth (4th) notch, aft of forward position. Put flaps in the fully retracted position and all control surfaces in the neutral position. Tow bar should be in the proper location and all entrance and baggage doors closed.
- (6) Weigh the airplane inside a closed building to prevent errors in scale readings due to wind.

**(b) Leveling**

- (1) With airplane on scales, block main gear oleo pistons in the fully extended position.
- (2) Level airplane (refer to Figure 6-3) deflating nose wheel tire, to center bubble on level.

(c) Weighing - Airplane Basic Empty Weight

- (1) With the airplane level and brakes released, record the weight shown on each scale. Deduct the tare, if any, from each reading.

Scale Position and Symbol	Scale Reading	Tare	Net Weight
Nose Wheel (N)			
Right Main Wheel (R)			
Left Main Wheel (L)			
Basic Empty Weight, as Weighed (T)	— —	— —	

WEIGHING FORM

Figure 6-1

(d) Basic Empty Weight Center of Gravity

- (1) The following geometry applies to the PA-34-200T airplane when it is level. Refer to Leveling paragraph 6.3 (b).

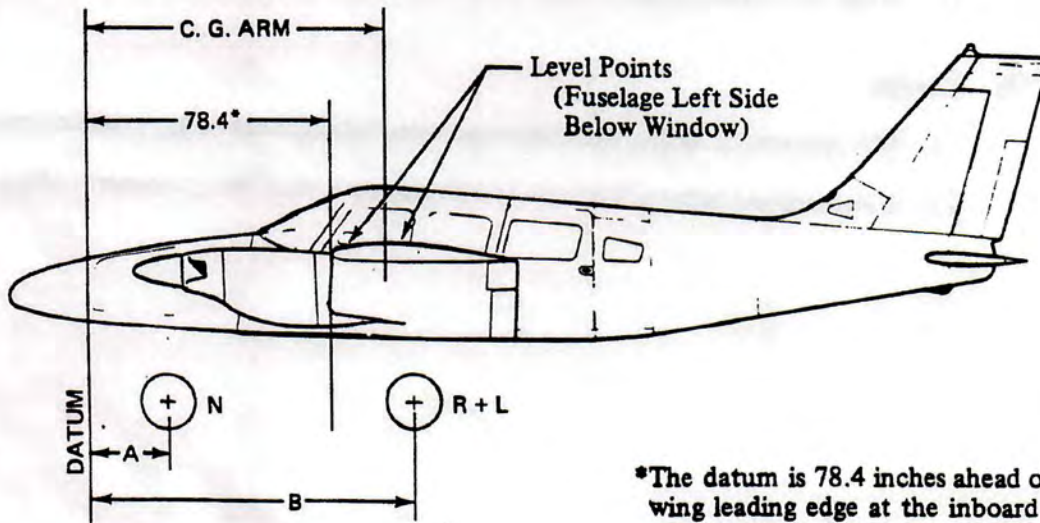

\*The datum is 78.4 inches ahead of the wing leading edge at the inboard edge of the inboard fuel tank.

A = 25.3  
B = 109.8

LEVELING DIAGRAM

Figure 6-3

- (2) The basic empty weight center of gravity (as weighed including optional equipment, full oil and unusable fuel) can be determined by the following formula:

$$\text{C.G. Arm} = \frac{N(A) + (R+L)(B)}{T} \quad \text{inches}$$

Where:  $T = N + R + L$

**6.5 WEIGHT AND BALANCE DATA AND RECORD**

The Basic Empty Weight, Center of Gravity Location and Useful Load listed in Figure 6-5 are for the airplane as licensed at the factory. These figures apply only to the specific airplane serial number and registration number shown.

The basic empty weight of the airplane as licensed at the factory has been entered in the Weight and Balance Record (Figure 6-7). This form is provided to present the current status of the airplane basic empty weight and a complete history of previous modifications. Any change to the permanently installed equipment or modification which affects weight or moment must be entered in the Weight and Balance Record.



MODEL PA-34-200T SENECA II

Airplane Serial Number 34-8070084

Registration Number N35727

Date 12-27-83 *See Summary*

THIS PAGE ADDED WITH REV. #14.

AIRPLANE BASIC EMPTY WEIGHT

Item	Weight (Lbs)	x	C.G. Arm (Inches Aft of Datum)	=	Moment (In-Lbs)
Standard Empty Weight* Actual Computed	2845.0		85.8		243958
Optional Equipment	346.3		102.5		35483
Basic Empty Weight <u>SEE SUMMARY</u>					

\*The standard empty weight includes full oil capacity and 5.0 gallons of unusable fuel.

AIRPLANE USEFUL LOAD - NORMAL CATEGORY OPERATION

(Gross Weight) - (Basic Empty Weight) = Useful Load

(4570 lbs) - (        lbs) =        lbs.

SEE SUMMARY

THIS BASIC EMPTY WEIGHT, C.G. AND USEFUL LOAD ARE FOR THE AIRPLANE AS LICENSED AT THE FACTORY. REFER TO APPROPRIATE AIRCRAFT RECORD WHEN ALTERATIONS HAVE BEEN MADE.

WEIGHT AND BALANCE DATA FORM

Figure 6-5

THIS PAGE INTENTIONALLY LEFT BLANK

PA-34-200T	Date	Item No.		Serial Number	Description of Article or Modification	Registration Number				Page Number														
		In	Out			Weight Change		Removed (-)		Running Basic Empty Weight														
						Wt. (Lb.)	Arm (In.)	Wt. (Lb.)	Arm (In.)	Wt. (Lb.)	Moment (/100)	Wt. (Lb.)	Moment (/100)											
					As Licensed																			

WEIGHT AND BALANCE RECORD

Figure 6-7

ISSUED: AUGUST 23, 1976  
 REVISED: JUNE 30, 1983

REPORT: VB-850  
 6-9

PA-34-200T	Serial Number	Registration Number	Page Number	Weight Change			Running Basic Empty Weight		
				Added (+)		Removed (-)		Wt. Moment /100	Wt. Moment /100
				Wt. (Lb.)	Arm (In.)	Wt. (Lb.)	Arm (In.)		
				Wt. Moment /100	Arm (In.)	Wt. Moment /100	Arm (In.)		
Date									
Item No.									
In									
Out									
Description of Article or Modification									

WEIGHT AND BALANCE RECORD (cont)

Figure 6-7 (cont)

## 6.6 GENERAL LOADING RECOMMENDATIONS

The following general loading recommendation is intended only as a guide. The charts, graphs, instructions and plotter should be checked to assure the airplane is within the allowable weight vs. center of gravity envelope.

- (a) Pilot only  
Load rear baggage compartment to capacity first. Without aft baggage, fuel load may be limited by forward envelope for some combinations of optional equipment
- (b) 2 occupants - pilot and passenger in front  
Load rear baggage compartment to capacity first. Without aft baggage, fuel load may be limited by forward envelope for some combinations of optional equipment.
- (c) 3 occupants - 2 in front, 1 in middle  
Load rear baggage compartment to capacity first. Baggage in nose may be limited by forward envelope. Without aft baggage, fuel may be limited by forward envelope for some combinations of optional equipment.
- (d) 4 occupants - 2 in front, 2 in middle  
Load rear baggage compartment to capacity first. Baggage in nose may be limited by forward envelope. Without aft baggage, fuel may be limited by forward envelope for some combinations of optional equipment.
- (e) 5 occupants - 2 in front, 2 in middle, 1 in rear  
Investigation is required to determine optimum location for baggage.
- (f) 5 occupants - 1 in front, 2 in middle, 2 in rear  
Load forward baggage to capacity first. Rear baggage and/or fuel load may be limited by aft envelope.
- (g) 6 occupants - 2 in front, 2 in middle, 2 in rear  
With six occupants fuel and/or baggage may be limited by envelope load forward baggage compartment to capacity first.
- (h) 7 occupants - 2 in front, 3 in middle, 2 in rear  
With seven occupants fuel and/or baggage may be limited by envelope.

\*For all airplane configurations, it is the responsibility of the pilot in command to make sure that the airplane always remains within the allowable weight vs. center of gravity while in flight.

THIS PAGE INTENTIONALLY LEFT BLANK

6.7 WEIGHT AND BALANCE DETERMINATION FOR FLIGHT

- (a) Add the weight of all items to be loaded to the basic empty weight.
- (b) Use the Loading Graph (Figure 6-13) to determine the moment of all items to be carried in the airplane.
- (c) Add the moment of all items to be loaded to the basic empty weight moment.
- (d) Divide the total moment by the total weight to determine the C.G. location.
- (e) By using the figures of item (a) and item (d) (above), locate a point on the C.G. range and weight graph (Figure 6-15). If the point falls within the C.G. envelope, the loading meets the weight and balance requirements.

	Weight (Lbs)	Arm Aft Datum (Inches)	Moment (In-Lbs)
Basic Empty Weight			
Pilot and Front Passenger	340.0	85.5	29070
Passengers (Center Seats) (Forward Facing)		118.1	
Passengers (Center Seats) (Aft Facing) (Optional)		119.1	
Passengers (Rear Seats)		157.6	
Passenger (Jump Seat) (Optional)		118.1	
Baggage (Forward)		22.5	
Baggage (Aft)		178.7	
Zero Fuel Weight ( <del>4168</del> Lbs Max - Std.) (See pages 6.61 and 6.62.)			
Fuel (93 Gallons Maximum) - Standard (123 Gallons Maximum) - Optional		93.6	
Total Loaded Airplane			

The center of gravity (C.G.) of this sample loading problem is at \_\_\_\_\_ inches aft of the datum line. Locate this point ( ) on the C.G. range and weight graph. Since this point falls within the weight - C.G. envelope, this loading meets the weight and balance requirements.

IT IS THE RESPONSIBILITY OF THE PILOT AND AIRCRAFT OWNER TO INSURE THAT THE AIRPLANE IS LOADED PROPERLY.

SAMPLE LOADING PROBLEM (NORMAL CATEGORY)

Figure 6-9

**SECTION 6  
WEIGHT AND BALANCE**

**PIPER AIRCRAFT CORPORATION  
PA-34-200T, SENECA II**

	Weight (Lbs)	Arm Aft Datum (Inches)	Moment (In-Lbs)
Basic Empty Weight			
Pilot and Front Passenger		85.5	
Passengers (Center Seats) (Forward Facing)		118.1	
Passengers (Center Seats) (Aft Facing) (Optional)		119.1	
Passengers (Rear Seats)		157.6	
Passenger (Jump Seat) (Optional)		118.1	
Baggage (Forward)		22.5	
Baggage (Aft)		178.7	
Zero Fuel Weight (4/68 Lbs Max - Std.) (See pages 6-61 and 6-62.)		93.2	
Fuel (93 Gallons Maximum) - Standard (123 Gallons Maximum) - Optional		93.6	
Total Loaded Airplane			

Totals must be within approved weight and C.G. limits. It is the responsibility of the airplane owner and the pilot to insure that the airplane is loaded properly. The Basic Empty Weight C.G. is noted on the Weight and Balance Data Form (Figure 6-5). If the airplane has been altered, refer to the Weight and Balance Record for this information.

**WEIGHT AND BALANCE LOADING FORM**

Figure 6-11

REPORT: VB-850  
6-12

ISSUED: AUGUST 23, 1976  
REVISED: JULY 9, 1979



LOADING GRAPH

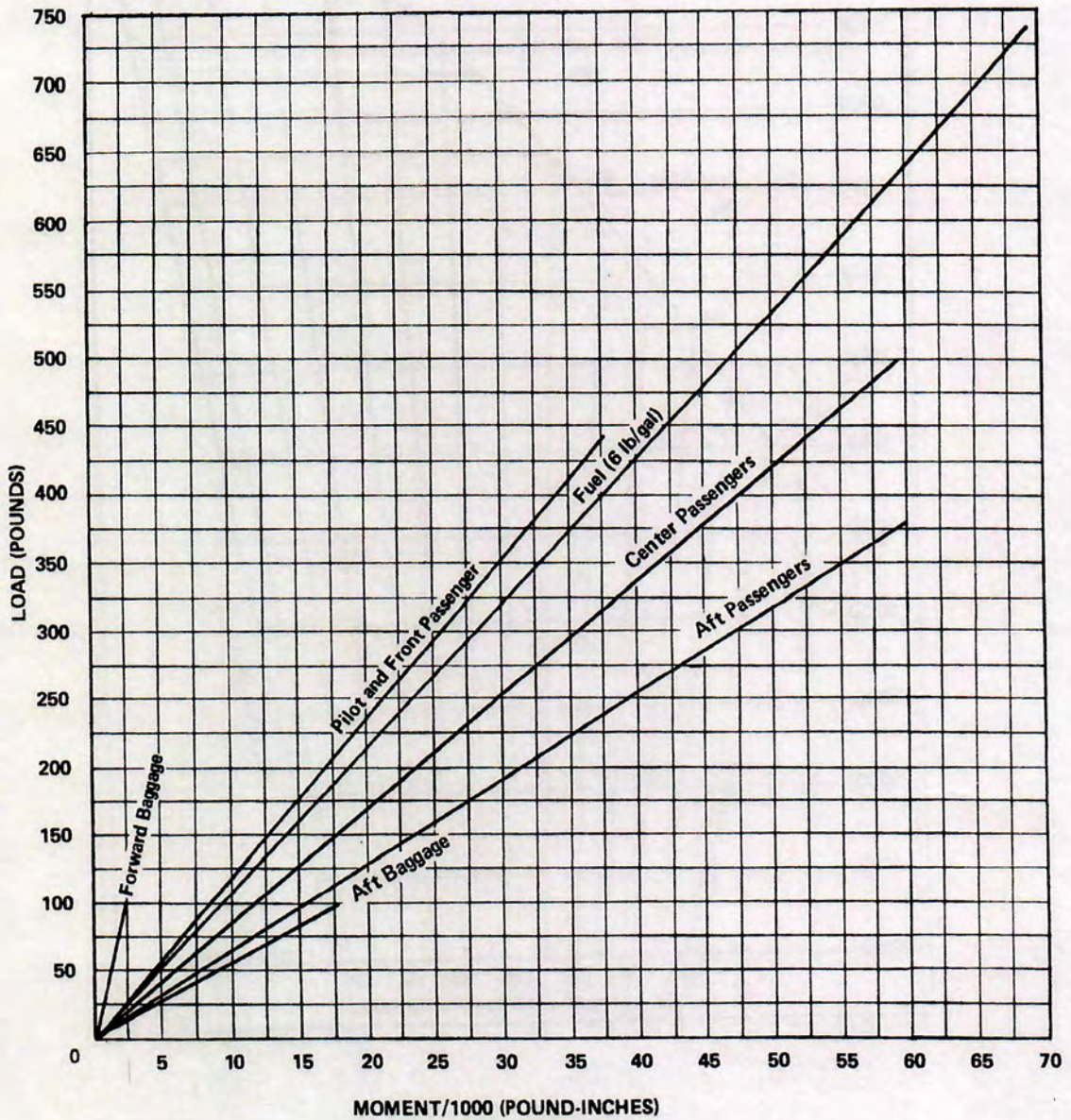

LOADING GRAPH

Figure 6-13

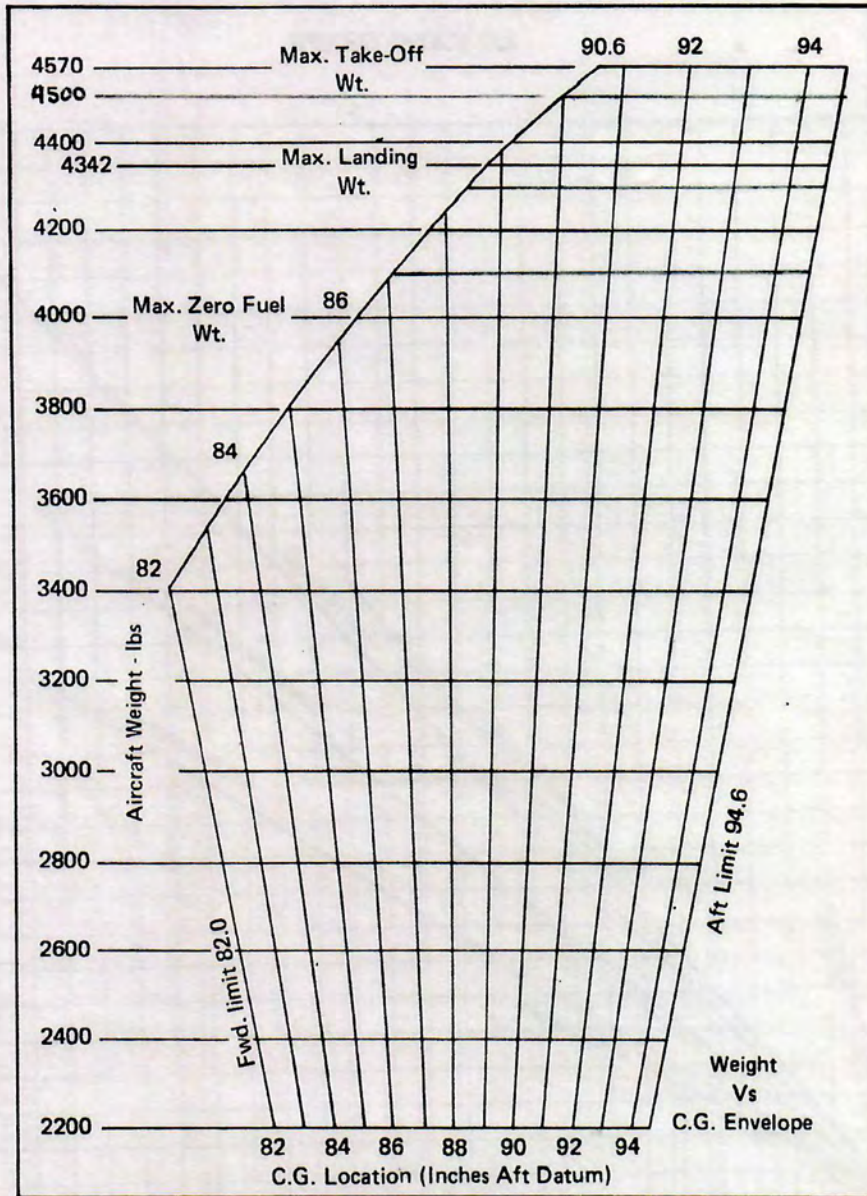

Moment change due to retracting Landing Gear = - 32 in.-lbs.

C. G. RANGE AND WEIGHT

Figure 6-15

**SECTION 6**  
**WEIGHT AND BALANCE**

**NO CHANGES EXCEPT:**

**6.1 GENERAL**

The addition of the ATS, Inc. Vortex Generator Kit increases the Zero Fuel Weight of Seneca II aircraft. Use the following C.G. Envelope Diagram .

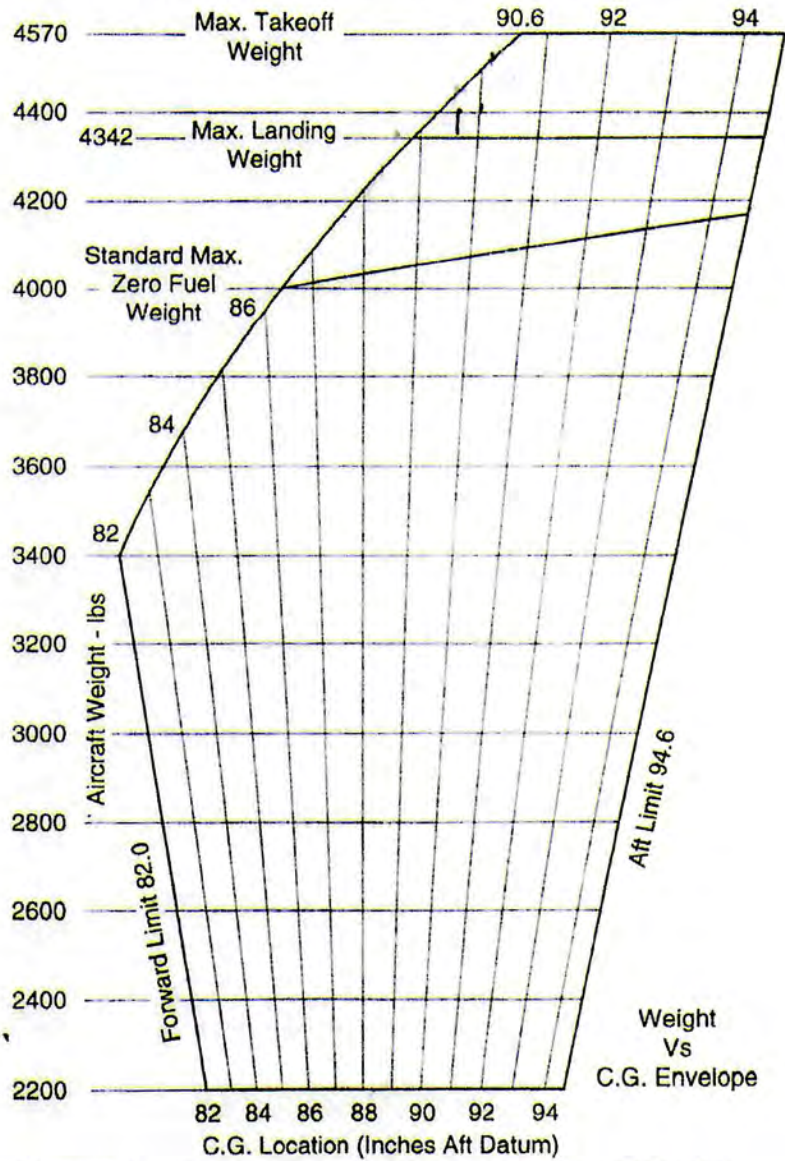

Moment change due to retracting Landing Gear = -32 in.-lbs.  
**C.G. RANGE AND WEIGHT**

For optional equipment Zero Fuel Weight increase see P.O.H.

94-04b

12-11-2011

12-11-2011

12-11-2011

12-11-2011

12-11-2011

12-11-2011

12-11-2011

12-11-2011

12-11-2011

12-11-2011

12-11-2011

12-11-2011

12-11-2011

12-11-2011

12-11-2011

12-11-2011

12-11-2011

12-11-2011

12-11-2011

## 6.8 INSTRUCTIONS FOR USING THE WEIGHT AND BALANCE PLOTTER

This plotter is provided to enable the pilot quickly and conveniently to:

- (a) Determine the total weight and C.G. position
- (b) Decide how to change his load if his first loading is not within the allowable envelope.

Heat can warp or ruin the plotter if it is left in the sunlight. Replacement plotters may be purchased from Piper dealers and distributors.

When the airplane is delivered, the basic weight and basic C.G. will be recorded on the computer. These should be changed any time the basic weight or C.G. location is changed.

The plotter enables the user to add weights and corresponding moments graphically. The effect of adding or disposing of useful load can easily be seen. The plotter does not cover the situation where cargo is loaded in locations other than on the seats or in the baggage compartments.

Brief instructions are given on the plotter itself. To use it, first plot a point on the grid to locate the basic weight and C.G. location. This can be put on more or less permanently because it will not change until the airplane is modified. Next, position the zero weight end of one of the six slots over this point. Using a pencil, draw a line along the slot to the weight which will be carried in that location. Then position the zero weight end of the next slot over the end of this line and draw another line representing the weight which will be located in this second position. When all the loads have been drawn in this manner, the final end of the segmented line locates the total load and the C.G. position of the airplane for takeoff. If this point is not within the allowable envelope it will be necessary to remove fuel, baggage, or passengers and/or to rearrange baggage and passengers to get the final point to fall within the envelope.

Fuel burn-off and gear movement do not significantly affect the center of gravity.

### SAMPLE PROBLEM

A sample problem will demonstrate the use of the weight and balance plotter.

Assume a basic weight and C.G. location of 2850 pounds at 83.5 inches respectively. We wish to carry a pilot and 5 passengers. Two men weighing 180 and 200 pounds will occupy the front seats, two women weighing 115 and 135 pounds will occupy the middle seats and two children weighing 80 and 100 pounds will ride in the rear. Two 25 pound suitcases will be tied down in the front baggage compartment and two suitcases weighing 25 pounds and 20 pounds respectively, will be carried in the rear compartment. We wish to carry 60 gallons of fuel. Will we be within the safe envelope?

- (1) Place a dot on the plotter grid at 2850 pounds and 83.5 inches to represent the basic airplane. (See illustration.)
- (2) Slide the slotted plastic into position so that the dot is under the slot for the forward seats, at zero weight.
- (3) Draw a line up the slot to the 380 pound position (180 + 200) and put a dot.
- (4) Move the slotted plastic again to get the zero end of the middle seat slot over this dot.
- (5) Draw a line up this slot to the 250 pound position (115 + 135) and place the 3rd dot.

- (6) Continue moving the plastic and plotting points to account for weight in the rear seats (80 + 100), forward baggage compartment (50), rear baggage compartment (45), and fuel tanks (360).
- (7) As can be seen from the illustration, the final dot shows the total weight to be 4115 pounds with the C.G. at 90.1. This is well within the envelope.
- (8) There will be room for more fuel.

As fuel is burned off, the weight and C.G. will follow down the fuel line and stay within the envelope for landing.

SAMPLE PROBLEM

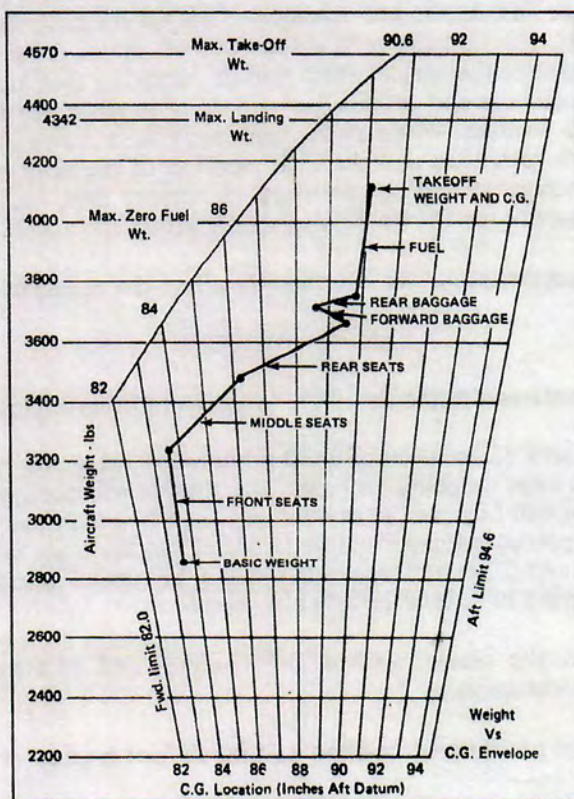

Moment change due to retracting Landing Gear = -32 in.-lbs.

6.9 EQUIPMENT LIST

The following is a list of equipment which may be installed in the PA-34-200T. It consists of those items used for defining the configuration of an airplane when the basic empty weight is established at the time of licensing. Only those standard items which are alternate standard items and those required to be listed by the certificating authority (FAA) are presented. Items marked with an "X" are those items which were installed on the airplane described below as delivered by the manufacturer.

PIPER AIRCRAFT CORPORATION

PA-34-200T SENECA II

SERIAL NO. \_\_\_\_\_ RESITRATION NO. \_\_\_\_\_ DATE: \_\_\_\_\_

(a) Propeller and Propeller Accessories

Item No.	Item	Mark if Instl.	Weight (Pounds)	Arm (In.) Aft Datum	Moment (Lb-In.)
1	Two Propellers Cert. Basis - TC P920 Hartzell Model BHC-C2YF-2CKF/ FC8459-8R or FC8459B-8R (Left Wing) Hartzell Model BHC-C2YF-2CLKF/ FJ8459-8R or FJC8459B-8R (Right Wing) OR Hartzell Model BHC-C2YF-2CKUF/ FC8459-8R or FC8459B-8R (Left Wing) Hartzell Model BHC-C2YF-2CLKUF/ FJC8459-8R or FJC8459B-8R (Right Wing)				
3	Two Hyrdraulic Governors Cert. Basis - TC P920 Woodward Governor, Piper Dwg. 37476-0 (Left Wing)	_____	2.7	28.1	76
	Woodward Governor, Piper Dwg. 37476-2 (Right Wing)	_____	2.7	28.1	76
	OR Hartzell Governor Model E-3 (Left Wing)	_____	3.9	28.1	110
	Hartzell Governor Model E-3L (Right Wing)	_____	3.9	28.1	110

**THIS PAGE INTENTIONALLY LEFT BLANK**



(b) Engine and Engine Accessories

Item No.	Item	Mark if Instl.	Weight (Pounds)	Arm (In.) Aft Datum	Moment (Lb-In.)
5	Two Engines Cert. Basis - TC E9CE Teledyne Continental Model TSIO-360-E or TSIO-360-EB Fuel Injected Turbocharged (Left Wing) Teledyne Continental Model LTSIO-360-E or LTSIO-360-EB Fuel Injected Turbocharged (Right Wing)				 

THIS PAGE INTENTIONALLY LEFT BLANK

(c) Landing Gear and Brakes

Item No.	Item	Mark if Instl.	Weight (Pounds)	Arm (In.) Aft Datum	Moment (Lb-In.)
11	Two Main Wheel Assemblies				
	a. Cleveland Aircraft Products				
	Wheel Assy. No. 40-90				
	Brake Assy. No. 30-65				
	Cert. Basis - TSO C26a				
	b. 6.00-6 Type III 8 Ply				
	Rating Tires with Regular Tubes				
	Cert. Basis - TSO C62				
13	Nose Wheel Assembly				
	a. Cleveland Aircraft Products				
	Wheel Assy. No. 40-76F	<input checked="" type="checkbox"/>	4.3	25.3	109
	Cert. Basis - TSO C26a				
	b. McCauley Industrial Corp.				
	Wheel Assy. No. D-30625	<input type="checkbox"/>	5.5	25.3	139
	Cert. Basis - TSO C26b				
	c. 6.00-6 Type III 6 Ply				
	Rating Tire with Regular Tubes				
	Cert. Basis - TSO C62				

THIS PAGE INTENTIONALLY LEFT BLANK

(d) Electrical Equipment

Item No.	Item	Mark if Instl.	Weight (Pounds)	Arm (In.) Aft Datum	Moment (Lb-In.)
17	Navigation Light (Rear) Grimes A2064 Cert. Basis - TSO C30b				
19	Navigation Light (Wing) (2) Grimes A1285-G-12 A1285-R-12 Cert. Basis - TSO C30b				
21	Stall Warning Devices Piper Dwg. 37063-0 (Safe Flight P/N 186-501)	_____	0.4	80.2	32
23	Stall Warning Horn Piper Dwg. 37063-0 (Safe Flight P/N 35214)	_____	0.2	60.9	12

**THIS PAGE INTENTIONALLY LEFT BLANK**

(e) Instruments

Item No.	Item	Mark if Instl.	Weight (Pounds)	Arm (In.) Aft Datum	Moment (Lb-In.)
25	Altimeter - Piper PS50008-4 or -5 Cert. Basis - TSO C10b				
27	Airspeed Indicator - Piper PS50049-40S Cert. Basis - TSO C2b				
29	Compass - Piper Dwg. 67462 Cert. Basis - TSO C7c				
31	Manifold Pressure (Dual) - Piper 37554 or 87374-2 Cert. Basis - TSO C45				
33	Fuel Flow Gauge (Dual) - Piper 37341 Cert. Basis - TSO C47	X			

THIS PAGE INTENTIONALLY LEFT BLANK



(f) Miscellaneous

Item No.	Item	Mark if Instl.	Weight (Pounds)	Arm (In.) Aft Datum	Moment (Lb-In.)
41	Front Seat Belts (2) Piper PS50039-4-2 Cert. Basis - TSO C22f (American Safety Eqpt. Corp. 500576) (Davis Acft. Prod. Inc. FDC-5900-120-5) (Black)	_____	1.9	86.9	165
43	Center Seat Belts (2) Piper PS50039-4-3 Cert. Basis - TSO C22f (American Safety Eqpt. Corp. 500577) (Davis Acft. Prod. Inc. FDC-5900-120-6) (Black)	_____	1.6	123.0	197
45	Aft Seat Belts (2) Piper PS50039-4-4 Cert. Basis - TSO C22f (American Safety Eqpt. Corp. 500578) (Davis Acft. Prod. Inc. FDC-5900-120-7) (Black)	_____	1.6	163.0	261
47	Shoulder Harness - Fixed (Front) (2) Piper PS50039-4-24 (American Safety Eqpt. Corp. 501385-405) (Davis Acft. Prod. Inc. FDC-7275-16-5) (Black)	_____	1.1	120.1	132
49	Combustion Heater Piper Dwg. 37164-0 (45,000 BTU) Cert. Basis - TC A760	_____	26.0	215.0	5590

**THIS PAGE INTENTIONALLY LEFT BLANK**

(g) Engine and Engine Accessories  
(Optional Equipment)

Item No.	Item	Mark if Instl.	Weight (Pounds)	Arm (In.) Aft Datum	Moment (Lb-In.)
51	Optional Engine Primer System, Piper Dwg. 37865-2 Cert. Basis - TC A7SO	<u>  X  </u>	3.1	38.5	119

THIS PAGE INTENTIONALLY LEFT BLANK

(h) Propeller and Propeller Accessories  
(Optional Equipment)

Item No.	Item	Mark if Instl.	Weight (Pounds)	Arm (In.) Aft Datum	Moment (Lb-In.)
59	Two Propellers				
	McCauley Model 3AF34C502/80HA-4 (Left Wing)				
	McCauley Model 3AF34C503/L80HA-4 (Right Wing)	x			
	Cert. Basis - P 57GL	_____	*37.2	20.3	755
60	Synchrophasers	x			
	Piper Dwg. 36890				
	Cert. Basis - TCA7SO	_____	5.9	61.3	362

\*Weight and moment difference between standard and optional equipment.

THIS PAGE INTENTIONALLY LEFT BLANK

(i) Landing Gear and Brakes  
(Optional Equipment)

Item No.	Item	Mark if Instl.	Weight (Pounds)	Arm (In.) Aft Datum	Moment (Lb-In.)
67	Heavy Duty Group No. 1 a. Cleveland Aircraft Products 40-120 Wheel Assy. (2) 30-83 Brake Assy. (2) Cert. Basis - TSO C26a  Goodrich 6.00 x 6 Ribbed Type III 8 Ply Rating Tire with Tube (2) Cert. Basis - TSO C62	<u>      </u>	*2.9	109.8	318
69	b. Goodrich 6.00 x 6 Ribbed Type III 8 Ply Rating Tire with Tube Cert. Basis - TSO C62	<u>      </u>	(Same as standard equipment)		

\*Weight and moment difference between standard and optional equipment.

THIS PAGE INTENTIONALLY LEFT BLANK



(j) Electrical Equipment  
(Optional Equipment)

Item No.	Item	Mark if Instl.	Weight (Pounds)	Arm (In.) Aft Datum	Moment (Lb-In.)
79	Reading Lights				
	a. (2) Grimes #10-0154-1	<u>  X  </u>	0.5	149.3	75
	b. (2) Grimes #10-0154-1	<u>  X  </u>	0.5	115.0	58
	Cert. Basis - TC A7SO				
81	Strobe Lights (Wing Tip) (Whelen) Piper Dwg. 95267 Cert. Basis - TC A7SO	<u>  X  </u>	*2.9	137.9	400
83	Piper Pitch Trim Piper Dwg. 95242-3 Cert. Basis - STC SA3023SW-D	<u>      </u>	2.6	178.8	465
85	Auxiliary Power Receptacle, Piper Dwg. 68815 Cert. Basis - TC A7SO	<u>  X  </u>	2.6	-7.8	-20
87	External Power Cable, Piper Dwg. 62355-2 Cert. Basis - TC A7SO	<u>  X  </u>	4.6	33.0	152
89	Lighter, #200462, 12 Volt Universal Cert. Basis - TC A7SO	<u>  X  </u>	.2	67.9	14

\* Weight and moment difference between standard and optional equipment.

**SECTION 6  
WEIGHT AND BALANCE**

**PIPER AIRCRAFT CORPORATION  
PA-34-200T, SENECA II**

(j) Electrical Equipment  
(Optional Equipment) (cont)

Item No.	Item	Mark if Instl.	Weight (Pounds)	Arm (In.) Aft Datum	Moment (Lb-In.)
-------------	------	-------------------	--------------------	------------------------	--------------------

(k) Instruments  
(Optional Equipment)

Item No.	Item	Mark if Instl.	Weight (Pounds)	Arm (In.) Aft Datum	Moment (Lb-In.)
113	Vacuum System Installation	<u>X</u>	2.2	67.3	148
	a. Two Vacuum Pumps, Piper Dwg. 79399-0 & -2	<u>X</u>	4.6	54.3	250
	b. Two Vacuum Pumps, Piper Dwg. 36535-2 (Edo-Aire P/N IU128A) Cert. Basis - TC A7S0	_____	4.4	54.3	239
115	Attitude Gyro, Piper Dwg. 99002-2, -3, -4 or -8 Cert. Basis - TSO C4c	_____	2.2	64.4	142
117	Directional Gyro, Piper Dwg. 99003-2, -3, -4 or -7 Cert. Basis - TSO C5c	_____	2.6	64.7	168
119	NSD-360 Gyro Cert. Basis - TSO C6c, C9c, C52c	_____	5.0	77.8	389
121	Tru-Speed Indicator Piper PS50049-40T Cert. Basis - TSO C2b	<u>X</u>	(Same as standard equipment)		
123	Encoding Altimeter, Piper PS50008-6 or -7 Cert. Basis - TSO C10b, C88	_____	* .9	65.9	59
124	Altitude Digitizer (United Instruments P/N 5125-P3) Cert. Basis - TSO C88	_____	1.0	56.2	56
125	Vertical Speed				
	a. Piper Dwg. 99010-2, -4 or -5	<u>X</u>	1.0	65.9	66
	b. Piper Dwg. 99010-3 Cert. Basis - TSO C8b	_____	.5	67.2	34
127	Turn and Slip Indicator, Piper PS50030-2 or -3 Cert. Basis - TSO C3b	<u>X</u>	2.6	64.7	168

\*Weight and moment difference between standard and optional equipment.

**SECTION 6  
WEIGHT AND BALANCE**

**PIPER AIRCRAFT CORPORATION  
PA-34-200T, SENECA II**

(k) Instruments  
(Optional Equipment) (cont)

Item No.	Item	Mark if Instl.	Weight (Pounds)	Arm (In.) Aft Datum	Moment (Lb-In.)
129	MK10 Radar Altimeter Piper Dwg. 37693-2 Cert. Basis - TC A7SO	_____	5.4	181.3	979
130	King KRA-10 Radio Altimeter	_____	4.3	188.2	809
131	Engine Hour Meter Piper Dwg. 37731-0 Cert. Basis - TC A7SO	_____	0.3	62.9	19
133	Clock Cert. Basis - TC A7SO	<u>  X  </u>	0.4	67.4	27
134	Control Wheel Digital Clock Piper Dwg. (37754-4)	_____	0.3	76.9	23
135	Air Temperature Gauge, Piper Dwg. 79316 Cert. Basis - TC A7SO	<u>  X  </u>	0.2	77.6	16

(k) Instruments  
(Optional Equipment) (cont)

Item No.	Item	Mark if Instl.	Weight (Pounds)	Arm (In.) Aft Datum	Moment (Lb-In.)
Copilot's Advanced Instrumentation:					
137	Attitude Gyro, Piper Dwg. 99002-2, -3, -4 or -8 Cert. Basis - TSO C4c	_____	2.2	64.4	142
139	Directional Gyro, Piper Dwg. 99003-2, -3, -4 or -7 Cert. Basis - TSO C5c	_____	2.6	64.7	168
141	Tru-Speed Indicator, Piper PS50049-40T Cert. Basis - TSO C2b	_____	0.6	66.8	40
143	Vertical Speed a. Piper Dwg. 99010-2, -4 or -5 b. Piper Dwg. 99010-3 Cert. Basis - TSO C8b	_____ _____	1.0 .5	65.9 67.2	66 34
145	Altimeter, Piper PS50008-4 or -5 Cert. Basis - TSO C10b	_____	1.0	65.9	66
147	Turn and Slip Indicator, Piper PS50030-2 or -3 Cert. Basis - TSO C3b	_____	2.6	64.7	168
149	Clock Cert. Basis - TC A7SO	_____	0.4	67.4	27

THIS PAGE INTENTIONALLY LEFT BLANK

(I) Autopilots  
(Optional Equipment)

Item No.	Item	Mark if Instl.	Weight (Pounds)	Arm (In.) Aft Datum	Moment (Lb-In.)
161	AutoControl IIIB	_____	6.7	89.4	599
	a. Directional Gyro # 52D54	_____	3.2	63.8	204
	b. Omni Coupler 1C-388P	_____	0.9	64.4	58
	Cert. Basis - STC SA3024SW-D				
163	AltiMatic IIIC	_____	20.1	110.8	2227
	a. Directional Gyro # 52D54	_____	3.2	63.8	204
	b. Omni Coupler 1C-388P	_____	0.9	64.4	58
	c. G/S Coupler 1C-493	_____	0.9	60.1	54
	Cert. Basis - STC SA3023SW-D				
165	King KFC-200 Flight Control System. KI-256 Flight Director and 3" Gyros.	_____			
	Cert. Basis - STC SA1147CE	<u>  X  </u>	49.4	145.0	7163
166	King KFC-200 Flight Control System. KG-258 Attitude Horizon Indicator and 3" Gyros.	_____			
	Cert. Basis - STC SA1147CE	_____	49.4	145.0	7163

→ Trim Drum Cable from King left side  
PIN 071-01096-0002 LT side cable

THIS PAGE INTENTIONALLY LEFT BLANK



(m) Radio Equipment  
(Optional Equipment) (cont)

Item No.	Item	Mark if Instl.	Weight (Pounds)	Arm (In.) Aft Datum	Moment (Lb-In.)
167	Bendix 2011 Dual Comm/Nav Cert. Basis - TSO C34c, C35d, C36c, C37b, C40a	_____	16.8	66.8	1122
168	Bendix IU 2014B Indicator Single Dual Cert. Basis - TSO C34c, C36c, C40a, C66c	_____ _____	1.9 3.8	63.4 63.4	121 241
169	Bendix TR-2060 Transponder Cert. Basis - TSO C74c	_____	2.8*	63.6	178
170	Bendix ADF 2070 Cert. Basis - TSO C41c, C2a	_____	6.0*	118.1	709
171	Bendix DME 2030 Cert. Basis - TSO C66a	_____	10.3*	22.9	236
172	Bendix NCP-2040 Nav Programmer	_____	5.4	64.2	347
173	Bendix IU 2016A Interface Cert. Basis - TS DOT-160, C2a	_____	4.9	27.2	133
174	Bendix Blower 14VDC	_____	1.1	58.6	64
175	Collins VHF-250 or VHF-251 Comm Transceiver Single Dual Cert. Basis - TSO C37b, C38b	<del>_____</del> <del>X</del>	4.0 8.1	61.9 61.9	248 501
176	Collins VIR-350 or VIR-351 Nav Receiver Single Dual Cert. Basis - TSO C40a, C36c	<del>_____</del> <del>X</del>	3.9 7.9	62.4 62.4	243 493

\*Weight includes antenna and cable.

ISSUED: JULY 9, 1979  
REVISED: NOVEMBER 19, 1980

REPORT: VB-850  
6-42a

**THIS PAGE INTENTIONALLY LEFT BLANK**

(m) Radio Equipment  
(Optional Equipment)

Item No.	Item	Mark if Instl.	Weight (Pounds)	Arm (In.) Aft Datum	Moment (Lb-In.)
177	Collins IND-350 ( ) VOR/LOC Indicator Single	<u>X</u>	1.0	65.2	65
	Dual Cert. Basis - TSO C40a, C36c	<u>    </u>	2.0	65.2	130
178	Collins IND-351 ( ) VOR/LOC/GS Indicator Cert. Basis - TSO C40a, C36c	<u>    </u>	1.3	65.2	85
179	Collins GLS-350 Glide Slope Receiver Cert. Basis - TSO C34c	<u>X</u>	*3.6	86.8	312
180	Collins ANS 351 R-NAV Cert. Basis - TSO C36c	<u>X</u>	3.8	63.2	240
181	Collins DCE 400 Distance Computing Equipment Cert. Basis - TSO C40a	<u>    </u>	2.1	63.9	134
182	Collins DME-451 with Ind. 450/451 Cert. Basis - TSO C66a	<u>X</u>	8.8	185.4	1632
183	Collins RCR-650 ADF Receiver and Antenna and IND-650 Indicator Cert. Basis - TSO C41c	<u>    </u>	7.0	122.1	855
184	Collins RCR-650A ADF Receiver and Antennas and IND-650A Indicator Cert. Basis - TSO C41c	<u>X</u>	7.7	116.7	899

\*Weight includes antenna and cable.

**SECTION 6  
WEIGHT AND BALANCE**

**PIPER AIRCRAFT CORPORATION  
PA-34-200T, SENECA II**

**(m) Radio Equipment  
(Optional Equipment) (cont)**

Item No.	Item	Mark if Instl.	Weight (Pounds)	Arm (In.) Aft Datum	Moment (Lb-In.)
185	Collins AMR-350 Audio/Marker Panel Cert. Basis - TSO C35d, C50b	<u>REMOVED</u> <u>X</u>	*3.3	123.9	409
186	Collins TDR-950 Transponder Cert. Basis - TSO C74c	<u>X</u>	*2.8	62.5	175
187	King KX 170 ( ) (VHF Comm/Nav) Transceiver, Single	<u>      </u>	7.5	61.6	462
	Transceiver, Dual	<u>      </u>	15.0	61.6	924
	Cert. Basis - TC A7SO				
188	King KN-53 NAV/REC. with GS Receiver a. Single	<u>      </u>	3.2	63.0	202
	b. Dual	<u>      </u>	6.4	63.0	404
189	King KN-53 NAV/Rec.	<u>      </u>	2.8	63.0	176

*Collins 950                          Removed*

*GARMIN GTX 327                          2.8                          62.5                          175*

*GARMIN GNS 430                          6.5 LBS                          63"                          411*

*PSE ENGINEERING PNA 7000                          1.1                          65"                          71.75*

\*Weight includes antenna and cable.

(m) Radio Equipment  
(Optional Equipment) (cont)

Item No.	Item	Mark if Instl.	Weight (Pounds)	Arm (In.) Aft Datum	Moment (Lb-In.)
190	King KX 175 ( ) VHF				
	a. Transceiver	_____	7.5	61.6	462
	b. King KN 72 VOR/LOC Converter	_____	1.3	12.0	16
	c. King KN 73 Glide Slope Receiver	_____	2.4	12.7	30
	d. King KN 75 Glide Slope Receiver	_____	1.6	12.7	20
	e. King KN 77 VOR/LOC Converter	_____	2.2	12.0	26
	f. King KI-204 VOR/ILS Indicator	_____	2.8	65.5	183
	g. King KNI 520 VOR/ILS Indicator	_____	2.8	65.5	183
	Cert. Basis - TSO C36c, C37b, C38b, C40a				
191	King KX 175 ( ) VHF				
	a. Transceiver (2nd),	_____	7.5	61.6	462
	b. King KN 72 VOR/LOC Converter	_____	1.3	12.0	16
	c. King KN 77 VOR/LOC Converter	_____	2.2	12.0	26
	d. King KI-203 VOR/LOC Indicator	_____	1.6	65.5	105
	e. King KNI 520 VOR/ILS Indicator	_____	2.8	65.5	183
	Cert. Basis - TSO C36c, C37b, C38b, C40a				
192	King KY 196E Transceiver				
	a. Single	_____	3.1	63.8	198
	b. Dual	_____	6.2	63.8	396
	Cert. Basis - TSO C37b, C38b				
193	King KY-197 Transceiver				
	a. Single	_____	4.2	63.7	267
	b. Dual	_____	8.4	63.7	534
	Cert. Basis - TSO C37B, C 38B				
194	King KI 201 ( ) VOR/LOC Indicator				
	Cert. Basis - TC A7SO	_____	2.5	64.9	162

**SECTION 6  
WEIGHT AND BALANCE**

**PIPER AIRCRAFT CORPORATION  
PA-34-200T, SENECA II**

(m) Radio Equipment  
(Optional Equipment) (cont)

Item No.	Item	Mark if Instl.	Weight (Pounds)	Arm (In.) Aft Datum	Moment (Lb-In.)
195	King KI-208 VOR/LOC Indicator Cert. Basis TSO C34c, C36c, C40a	_____	1.0	64.9	65
196	King KI-209 VOR/LOC/GS Indicator Cert. Basis - TSO C34c, C36c, C40a	_____	1.2	64.9	78
197	King KI 213 VOR/LOC/GS Indicator Cert. Basis - TC A7SO	_____	2.5	64.9	162
198	King KI 214 ( ) VOR/LOC/GS Ind. Cert. Basis - TC A7SO	_____	3.3	64.9	214
199	King KR-21 Marker Beacon Cert. Basis - TC A7SO	_____	*2.2	128.3	282
200	King KN-74 R-Nav Cert. Basis - TC A7SO	_____	4.7	61.3	288
201	King KNS-80 R-NAV	_____	7.0	62.3	436
202	King KI-206 R-Nav Indicator Cert. Basis - TSO C34c, C36c, C40a	_____	1.3	61.6	80
203	King KN 61 DME Cert. Basis - TC A7SO	_____	10.6	31.9	338
204	King KN-62A DME	_____	3.3	63.3	209
205	King KN 65A DME Cert. Basis - TSO C66a	_____	10.8	34.3	370
206	King KR 85 Digital ADF with KA-42B Loop and Sense Antenna a. Audio Amplifier Cert. Basis - TSO C41b	_____ _____	9.9 0.8	99.3 52.5	983 42
207	King KR 85 Digital ADF a. Audio Amplifier Cert. Basis - TSO C41b	_____ _____	9.0 0.8	99.3 52.5	894 42

\*Weight includes antenna and cable.

(m) Radio Equipment  
(Optional Equipment) (cont)

Item No.	Item	Mark if Instl.	Weight (Pounds)	Arm (In.) Aft Datum	Moment (Lb-In.)
208	King KR 86 ADF with KA-42B Loop and Sense Antenna				
	a. Single	_____	7.6	104.3	793
	b. Dual	_____	10.6	108.9	1154
	c. Audio Amplifier	_____	0.8	52.5	42
	Cert. Basis - TC A7SO				
209	King KR 86 ADF				
	a. Single	_____	6.7	104.3	699
	b. Dual	_____	**16.4	107.3	1760
	c. Audio Amplifier	_____	0.8	52.5	42
	Cert. Basis - TC A7SO				
210	King KR-87 Digital ADF with KA44 Antenna				
	a. Single	_____	*7.7	75.1	578
	b. Dual	_____	**13.9	74.9	1041
	c. Audio Amplifier	_____	0.8	54.1	43
	Cert. Basis - TSO C35c, C50b				
211	King KI-225 Slaved Card ADF	_____	1.5	66.3	99
212	King KMA 20 ( ) Audio Panel				
	Cert. Basis - TSO C35c, C50b	_____	*3.7	74.9	277
213	King KMA-24 Audio Control Panel	_____	1.7	65.3	111
214	King KT 76 ( )/78 ( ) Transponder				
	Cert. Basis - TSO C746	_____	*3.1	63.1	196
215	Narco Comm 11A VHF Transceiver				
	a. Single	_____	3.6	62.4	225
	b. Dual	_____	7.1	62.4	443
	Cert. Basis - TC A7SO				

\*Weight includes antenna and cable.

\*\*Weight includes dual antenna and cable.

**SECTION 6  
WEIGHT AND BALANCE**

**PIPER AIRCRAFT CORPORATION  
PA-34-200T, SENECA II**

(m) Radio Equipment  
(Optional Equipment) (cont)

Item No.	Item	Mark if Instl.	Weight (Pounds)	Arm (In.) Aft Datum	Moment (Lb-In.)
217	Narco Comm 11B VHF Transceiver				
	a. Single	_____	3.9	62.4	243
	b. Dual	_____	7.7	62.4	480
	Cert. Basis - TC A7SO				
219	Narco Comm 111 VHF Transceiver				
	a. Single	_____	3.0	62.4	187
	b. Dual	_____	6.0	62.4	374
	Cert. Basis - TSO C37b, C38b				
221	Narco Comm 111B VHF Transceiver				
	a. Single	_____	3.9	62.4	243
	b. Dual	_____	7.8	62.4	487
	Cert. Basis - TSO C37b, C38b				
223	Narco Comm 120 VHF Transceiver				
	a. Single	_____	4.8	61.9	297
	b. Dual	_____	8.6	62.4	537
	Cert. Basis - TSO C37b, C38b				
225	Narco Nav 11 VHF Receiver				
	Cert. Basis - TC A7SO	_____	2.8	63.6	178
227	Narco Nav 12 VHF Receiver				
	Cert. Basis - TC A7SO	_____	3.4	63.6	216
229	Narco Nav 14 VHF Receiver				
	Cert. Basis - TC A7SO	_____	2.5	63.6	159
231	Narco Nav 111				
	Cert. Basis - TSO C36c, C40a, C66a	_____	2.5	63.6	159
233	Narco Nav 112 Receiver				
	Cert. Basis - TSO C36c, C40a, C66c, C34c	_____	3.3	58.6	193
235	Narco Nav 114 VHF Receiver				
	Cert. Basis - TSO C38b, C40a, C36c, C34c, C66a	_____	2.5	63.6	159



(m) Radio Equipment  
(Optional Equipment) (cont)

Item No.	Item	Mark if Instl.	Weight (Pounds)	Arm (In.) Aft Datum	Moment (Lb-In.)
237	Narco Nav 121 VHF Receiver				
	a. Single	=====	3.1	63.5	197
	b. Dual	=====	6.2	63.4	393
	Cert. Basis - TSO C36c, C40c, C66a				
239	Narco Nav 122 VHF Receiver				
	a. Single	=====	*5.3	105.7	560
	b. Dual	=====	*8.8	87.5	770
	Cert. Basis - TSO C35d, C36c, C40c, C66a				
241	Narco Nav 122A VHF Receiver				
	a. Single	=====	*5.4	104.6	565
	b. Dual	=====	*9.0	86.8	781
	Cert. Basis - TSO C34c, C35d, C36c, C40c, C66a				
243	Narco Nav 124A VHF Receiver				
	a. Single	=====	*6.4	100.3	642
	b. Dual	=====	*11.1	84.2	935
	Cert. Basis - TSO C35d, C36c, C40a, C66a				
245	Narco Nav 124R VHF Receiver				
	Cert. Basis - TSO C36c, C40a, C66a	=====	4.4	62.4	275
247	Narco ID 124 VOR/LOC/GS Indicator				
	a. Single	=====	1.2	65.5	79
	b. Dual	=====	2.4	65.5	157
	Cert. Basis - TSO C34c, C35d, C36c, C40c				
249	Narco OC-110 Converter and Mount				
	Cert. Basis - TSO C36c, C40a	=====	2.1	231.5	486
251	Narco UGR-2A Glide Slope				
	a. First	=====	3.0	40.0	120
	b. Second	=====	3.0	40.0	120
	c. Second	=====	3.0	231.5	695
	Cert. Basis - TSO C34b				

\*Weight includes marker antenna and cable.

**SECTION 6  
WEIGHT AND BALANCE**

**PIPER AIRCRAFT CORPORATION  
PA-34-200T, SENECA II**

(m) Radio Equipment  
(Optional Equipment) (cont)

Item No.	Item	Mark if Instl.	Weight (Pounds)	Arm (In.) Aft Datum	Moment (Lb-In.)
253	Narco UGR-3 Glide Slope Cert. Basis - TC A7SO	_____	2.9	40.0	116
255	Narco MBT-12-R, Marker Beacon Cert. Basis - TC A7SO	_____	4.2	77.4	325
257	Narco CP-125 Audio Selector Panel Cert. Basis - TC A7SO	_____	2.2	76.2	168
259	Narco CP135 Audio Selector Panel Cert. Basis - TSO 650b	_____	2.2	76.2	168
261	Narco CP135M Audio Selector Panel Cert. Basis - TSO C50b, C35d	_____	*3.9	132.6	517
263	Narco CLC-60A R-Nav a. Narco SA-11 Adapter Cert. Basis - TC A7SO	_____ _____	11.5 0.8	142.0 13.0	1633 10
265	Narco DME-190 Cert. Basis - TC A7SO	_____	**5.9	65.9	389
267	Narco DME-190 TSO Cert. Basis - TSO C66a	_____	**5.9	65.9	389
269	Narco DME-195 Receiver and Indicator Cert. Basis - TSO C66a	_____	**10.9	29.0	316
271	Narco ADF-140 a. Single b. Dual Cert. Basis - TSO C41c	_____ _____	6.0 *17.9	104.7 96.3	628 1724
273	Narco ADF 141 a. Single b. Dual Cert. Basis - TSO C41c	_____ _____	6.0 *17.9	104.7 96.3	628 1724

\*Weight includes dual antenna and cable.  
\*\*Weight includes antenna and cable.

(m) Radio Equipment  
(Optional Equipment) (cont)

Item No.	Item	Mark if Instl.	Weight (Pounds)	Arm (In.) Aft Datum	Moment (Lb-In.)
275	Narco AT50A Transponder Cert. Basis - TSO C74b	—	**3.0	62.3	187
	a. Narco AR-500 Altitude Encoder Cert. Basis - TSO C88	—	1.0	57.5	58
277	Narco AT150 Transponder Cert. Basis - TSO C74c	—	**3.0	62.3	187
	a. Narco AR-500 Altitude Encoder Cert. Basis - TSO C88	—	1.0	57.5	58
289	Antenna and Cable				
	a. Nav Receiving	—	1.6	206.9	331
	b. *1 VHF Comm	—	0.8	147.5	118
	c. *2 VHF Comm	—	0.9	167.8	151
	d. Glide Slope (Single)	—	0.9	96.7	87
	e. Glide Slope (Dual)	—	2.8	180.0	504
	f. Single ADF Sense Cert. Basis - TC A7SO	—	0.4	160.0	64
290	Marker Beacon Antenna Piper PS50040-15 King KA-23 or Narco VMA-15 or Commant CI-102				
			Included as part of marker beacon installation		
291	Anti Static Antenna and Cable				
	a. *1 VHF Comm	—	1.5	162.7	244
	b. *2 VHF Comm	—	1.6	192.5	308
	c. Single ADF Sense Cert. Basis - TC A7SO	—	0.6	160.0	96
293	Emergency Locator Transmitter (C.C.C. Model CIR-11-2)				
	a. Antenna and Coax	—	1.7	267.2	454
	b. Shelf and Access Hole	—	0.2	255.4	51
	Cert. Basis - TSO C91	—	0.5	266.4	133

\*\*Weight includes antenna and cable.

**SECTION 6  
WEIGHT AND BALANCE**

**PIPER AIRCRAFT CORPORATION  
PA-34-200T, SENECA II**

(m) Radio Equipment  
(Optional Equipment) (cont)

Item No.	Item	Mark if Instl.	Weight (Pounds)	Arm (In.) Aft Datum	Moment (Lb-In.)
294	Emergency Locator Transmitter (Narco Model ELT-10)	_____	3.5	267.2	935
	a. Antenna and Coax	_____	0.3	255.4	77
	b. Shelf and Access Hole	_____	0.5	266.4	133
	Cert. Basis - TSO C91				
295	Microphone				
	a. Piper Dwg. 68856-10	_____	0.3	70.8	21
	b. Piper Dwg. 68856-11	_____	0.6	69.9	42
	c. Piper Dwg. 68856-12 (Single)	_____	0.3	70.8	21
	Piper Dwg. 68856-12 (Dual)	_____	0.6	70.8	42
	d. Piper Dwg. 79036-5 (Single)	_____	0.6	69.9	42
	e. Piper Dwg. 79036-6 (Dual)	_____	1.2	69.9	84
	Cert. Basis - TC A7SO				
297	Boom Microphone - Headset Piper Dwg. - 37021- ( )				
	a. Single	_____	0.3	85.5	26
	b. Dual	_____	0.6	85.5	51
	Cert. Basis - TC A7SO				
299	Cabin Speaker, Piper Dwg. 99820				
	Cert. Basis - TC A7SO	_____	1.1	97.5	107
301	Headset, Piper Dwg. 68856-10				
	Cert. Basis - TC A7SO	_____	0.5	65.0	33
303	Bendix Radar Piper Dwg. 37916-2				
	Cert. Basis - TSO C63b	_____	19.5	12.4	242
304	Bendix Radar Piper Dwg. 37916-4				
	Cert. Basis - TSO C63b	_____	23.5	21.2	498
305	Radio Shelf Piper Dwg. 69977-2				
	Cert. Basis - TC A7SO	_____	0.9	229.0	206

(m) Radio Equipment  
(Optional Equipment) (cont)

Item No.	Item	Mark if Instl.	Weight (Pounds)	Arm (In.) Aft Datum	Moment (Lb.-In.)
307	RCA - Weather Scout II Monochrome Radar Piper Dwg. 37916-5 Cert. Basis - TSO C63b	_____	15.7	9.2	144
309	RCA - Weather Scout II Color Radar Piper Dwg. 37916-7 Cert. Basis - TSO C63b	_____	25.0	24.3	607
	Sigtronics SPA-400 Intercom	X	1.0	60.0	60
	SHAWN FF GAGE PIN 910532P SIN 4180	X	1.0	61.0	33.6
	SHAWN FF TRANSUCERS PIN 680501X	X	.7	48.0	
	* REMOVED FF GAGE UNITED 6221				
	KWX 56 RADAR DISPLAY (4/81)		8.9	60	
	KA126 RADAR ANTENNA (4/81)		9.9	-14.7	

**THIS PAGE INTENTIONALLY LEFT BLANK**

(n) Miscellaneous  
(Optional Equipment)

Item No.	Item	Mark if Instl.	Weight (Pounds)	Arm (In.) Aft Datum	Moment (Lb-In.)
351	Zinc Chromate Finish Cert. Basis - TC A7SO	<u>X</u>	6.0	172.0	1032
353	Stainless Steel Control Cables Cert. Basis - TC A7SO	<u>X</u>	-	-	-
355	Ice Protection System Installation Piper Dwg. 37700 Cert. Basis - TC A7SO				
a.	Windshield Heating Unit Piper Dwg. 78162-0	<u>X</u>	2.6	59.6	155
b.	Heated Pitot Head and Lift Detectors	<u>X</u>	0.4	100.0	40
c.	Ice Light Kit Piper Dwg. 37700-3	<u>X</u>	0.4	72.0	29
d.	Electrothermal Hartzell Propeller Deicing System Piper Dwg. 37700-3	<u>-</u>	11.6	39.2	455
e.	Electrothermal McCauley Propeller Deicing System Piper Dwg. 37700-8	<u>X</u>	10.2	28.0	286
f.	Pneumatic Deicing System Including Vacuum Pumps Piper Dwg. 37700-2	<u>X</u>	<del>27.5</del> 34.3	<del>128.7</del> 111.9	<del>3536.0</del> 3839

**SECTION 6  
WEIGHT AND BALANCE**

**PIPER AIRCRAFT CORPORATION  
PA-34-200T, SENECA II**

(n) Miscellaneous  
(Optional Equipment) (cont)

Item No.	Item	Mark if Instl.	Weight (Pounds)	Arm (In.) Aft Datum	Moment (Lb-In.)
357	Fuel Cells, Piper Dwg. 37077-3 Cert. Basis - TSO C80	x	6.2	93.6	580
358	Air Conditioning Installation Cert. Basis - TC A7SO	x	53.1	108.6	5767
359	Ground Ventilating Blower, Piper Dwg. 79273-5 Cert. Basis - TC A7SO	—	8.1	207.3	1679
361	Super Cabin Sound Proofing, Piper Dwg. 78480 Cert. Basis - TC A7SO	x	24.2	107.2	2594
363	Adjustable Front Seat (Left), Piper Dwg. 79592-0/79592-2 Cert. Basis - TC A7SO	y	*4.6	84.7	390
365	Adjustable Front Seat (Right), Piper Dwg. 79592-1/79592-3 Cert. Basis - TC A7SO	z	*4.6	84.1	387
367	Jump Seat (with seat belts), Piper Dwg. 78108-9 Cert. Basis - TC A7SO	—	9.2	122.3	1125
369	Club Seating	x			
	a. With Regular Headrests on Center Seats	—	*13.2	90.4	1193
	b. With Oversize Headrests on Center Seats Piper Dwg. 37825-3 Cert. Basis - TC A7SO	—	*14.2	90.4	1284
371	Inboard Armrest - Aft Seats Cert. Basis - TC A7SO	x	2.6	152.0	395
373	Headrests (2) Front, Piper Dwg. 79337-18 Cert. Basis - TC A7SO	x	2.0	99.5	199

\*Weight and moment difference between standard and optional equipment.



(n) Miscellaneous  
(Optional Equipment) (cont)

Item No.	Item	Mark if Instl.	Weight (Pounds)	Arm (In.) Aft Datum	Moment (Lb-In.)
375	Headrests (2) Center, Piper Dwg. 79337-18 Cert. Basis - TC A7SO	_____	2.0	132.1	264
379	Headrests (2) Rear, Piper Dwg. 79337-18 Cert. Basis - TC A7SO	_____ X	2.0	171.5	343
381	Oversize Headrests - Front (2) Cert. Basis - TC A7SO	_____	3.2	99.5	318
385	Oversize Headrests - Center (2) (Fwd. facing seats only) Cert. Basis - TC A7SO	_____	3.2	132.1	423
387	Oversize Headrests - Aft (2) Cert. Basis - TC A7SO	_____	3.2	171.5	549
389	Inertia Safety Belts (Center) (2) .75 lbs. each, Piper PS50039-4-15 Cert. Basis - TC A7SO (Pacific Scientific 1107319-03) (American Safety Eqpt. Corp. 500853-403) (Black)	_____	1.5	133.9	201
391	Inertia Safety Belts (Rear) (2) 0.8 lbs. each, Piper PS50039-4-14 Cert. Basis - TC A7SO (Pacific Scientific 1107319-01) (American Safety Eqpt. Corp. 500853-401) (Black)	_____ X	1.6	181.5	290
392	Shoulder Harness - Inertia (Front) (2) Piper PS50039-4-21 (Pacific Scientific 1107447-05) (Black)	_____	1.3	120.1	156
393	Shoulder Harness - Fixed (Center) (2) Piper PS50039-4-22 (American Safety Eqpt. Corp. 501385-403) (Davis Acft. Prod. Inc. FDC-7275-16-2) (Black)	_____	1.1	133.9	147

**SECTION 6  
WEIGHT AND BALANCE**

**PIPER AIRCRAFT CORPORATION  
PA-34-200T, SENECA II**

(n) Miscellaneous  
(Optional Equipment) (cont)

Item No.	Item	Mark if Instl.	Weight (Pounds)	Arm (In.) Aft Datum	Moment (Lb-In.)
394	Shoulder Harness - Inertia (Center) (2) Piper PS50039-4-19 (Pacific Scientific 1107447-01) (Black)	_____	1.3	133.9	174
395	Shoulder Harness - Fixed (Rear) (2) Piper PS50039-4-22 (American Safety Eqpt. Corp. 501385-403) (Davis Acft. Prod. Inc. FDC-7275-16-2) (Black)	_____	1.1	181.5	200
396	Shoulder Harness - Inertia (Rear) (2) Piper PS50039-4-19 (Pacific Scientific 1107447-01) (Black)	_____	1.3	181.5	236
397	Assist Straps, Piper Dwg. 79455 Cert. Basis - TC A7SO	_____ X _____	.3	120.0	36
398	Curtain and Rod Installation Piper Dwg. 79721-2 Cert. Basis - TC A7SO	_____	1.9	143.6	273
399	Curtain and Rod Installation Piper Dwg. 67955-3 Cert. Basis - TC A7SO	_____ X _____	5.2	143.6	747
400	Refreshment Console Cert. Basis - TC A7SO	_____ X _____	7.0	118.5	830
401	Executive Writing Table Piper Dwg. 36800-2 Cert. Basis - TC A7SO	_____ X _____	3.9	**185.6	724
402	Deluxe Carpeting Cert. Basis - TC A7SO	_____	*-3.4	120.0	-408

\*Weight and moment difference between standard and optional equipment.  
\*\*Stowed Position

(n) Miscellaneous  
(Optional Equipment) (cont)

Item No.	Item	Mark if Instl.	Weight (Pounds)	Arm (In.) Aft Datum	Moment (Lb-In.)
403	Luxurious Interior Piper Dwg. 67954-2 Cert. Basis - TC A7SO	<u>X</u>	25.0	120.0	3000
405	Fire Extinguisher	<u>      </u>			
	a. Piper Dwg. 78621-2 Scott 42211-00	<u>      </u>	5.0	56.0	280
	b. Piper Dwg. 35680-2 Graviner HA1014-01 Cert. Basis - TC A7SO	<u>      </u>	5.6	62.8	352
407	Tow Bar Piper Dwg. 96331-0 Cert. Basis - TC A7SO	<u>      </u>	4.4	8.0	35
409	Oxygen System - Scott Aviation MKIII (Incl. (1) Mike Mask)				
	a. Piper Dwg. 37684 (Forward Facing Seating Arrangement) Scott 802180-00	<u>      </u>	41.0	112.9	4629
	b. Piper Dwg. 37825-4 (Club Seating Arrangement) Scott 802180-01 Cert. Basis - TC A7SO	<u>      </u>	41.6	112.9	4697
410	Fixed Oxygen System - Scott Aviation, Ambassador MK III System, Piper Dwg. 36960-3				
	a. Charged	<u>      </u>	45.5	201.3	9159
	b. Uncharged	<u>      </u>	40.2	200.1	8044
	Cert. Basis - TC A7SO				
	TOTAL OPTIONAL EQUIPMENT		<u>      </u>	<u>      </u>	<u>      </u>

EXTERIOR FINISH

Base Color SANDALWOOD TAN  
Trim Color BAYA YELLOW  
OCALE ORANGE  
Accent Color HICKORY BROWN

Registration No. Color BLACK  
Type Finish POLYURETHANE

**THIS PAGE INTENTIONALLY LEFT BLANK**

(n) Miscellaneous  
(Optional Equipment) (cont)

Item No.	Item	Mark if Instl.	Weight (Pounds)	Afm (In.) Aft Datum	Moment (Lb-In.)
410	Fixed Oxygen System - Scott Aviation, Ambassador MK III System, Piper Dwg. 36960-3				
	a. Charged	==	45.5	201.3	9159
	b. Uncharged	==	40.2	200.1	8044
	Cert. Basis - TC A7SO				
	<b>TOTAL OPTIONAL EQUIPMENT</b>		<u>346.3</u>	<u>102.5</u>	<u>35483</u>

*Superceded*

EXTERIOR FINISH

Base Color Sandalwood Tan  
Trim Color Baja Yellow  
Ocala Orange  
Accent Color Hickory Brown

Registration No. Color Black  
Type Finish Polyurethane

*Superceded rev. 3/3/81*

Original

THIS PAGE INTENTIONALLY LEFT BLANK

(o) Maximum Zero Fuel Weight Increase

Certain items of optional equipment are either partially or wholly installed in the wing of the Seneca II, and hence need not be counted against the centerline loading restriction. The following is a list of these items:

Item	Mark if Instl.	Amount By Which Max. Zero Fuel Weight May Be Increased (Pounds)
Optional Engine Primer System Piper Dwg. 37865-2 Cert. Basis - TC A7SO	X <hr/>	1.4
Two Propellers McCauley Model 3AF34C502/80HA-4 (Left Wing) McCauley Model 3AF34C503/L80HA-4 (Right Wing) Cert. Basis - P57GL	   X <hr/>	   17.8
Synchrophasers Piper Dwg. 36890 Cert. Basis - TC A7SO	  X <hr/>	  1.4
Heavy Duty Group No. 1 a. Cleveland Aircraft Products 40-120 Wheel Assy. (2) 30-83 Brake Assy. (2) Cert. Basis - TSO C26a Goodrich 6.00 x 6 Ribbed Type III 8 Ply Rating Tire With Tube (2) Cert. Basis - TSO C62	       X <hr/>	       0.3
Strobe Lights (Wing Tip) (Whelen) Piper Dwg. 95267 Cert. Basis - TC A7SO	   X <hr/>	   2.5
Vacuum System Installation a. Two Vacuum Pumps, Piper Dwg. 79399-0 & -2* Cert. Basis - TC A7SO	   X <hr/>	   2.2*
Heated Pitot Head Piper Dwg. 37700 Cert. Basis - TC A7SO	   X <hr/>	   0.5

\*Not installed with pneumatic deicing system.

**SECTION 6  
WEIGHT AND BALANCE**

**PIPER AIRCRAFT CORPORATION  
PA-34-200T, SENECA II**

(o) Maximum Zero Fuel Weight Increase (cont)

Item	Mark if Instl.	Amount By Which Max. Zero Fuel Weight May Be Increased (Pounds)
Electrothermal Hartzell Propeller Deicing System Piper Dwg. 37700 Cert. Basis - TC A7SO	_____	4.9
Electrothermal McCauley Propeller Deicing System Piper Dwg. 37700 Cert. Basis - TC A7SO	<u>X</u>	4.2
Pneumatic Deicing System Including Vacuum Pumps Piper Dwg. 37700 Cert. Basis - TC A7SO	<u>X</u>	22.4
Fuel Cells Piper Dwg. 37077-3 Cert. Basis - TSO C80	<u>X</u>	7.9
Air Conditioning Installation Piper Dwg. 36809 Cert. Basis - TC A7SO	<u>X</u>	19.3
Wing Tip Landing Lights STC SA 1401 NW	<u>X</u>	4.0
Total of Installed Items		<del>53.3</del> lbs.

11-21-80 JAH

X

S/S 500 11/23/80

Therefore, the new maximum zero fuel wt. of the airplane is:

Standard  
(Max. Zero Fuel Wt.) + (Wing Options) = New Max. Zero Fuel Wt.

(4000 lbs.) + (~~53.3~~ lbs.) = ~~4053.3~~ lbs.

~~77.9~~ 4077.9 JAH  
83.9 = 4083.9 JAH

X Remand

~~77.9~~  
83.9 ~~X.G.W~~



### Aircraft Weight and Balance Revision Form

Date: 09/15/2017

Aircraft	
Tail No:	N35727
Make:	Piper
Model:	PA34-200T
Serial:	34-8070084
Time:	
TCD No:	

Registered Owner	
Name:	John Griffiths
Address:	3813 E Kenwood St Mesa, AZ 85215

Weight	CG Range	
Maximum Weight:	4570.00	
	FWD:	82      AFT: 94.6

As Received			
Previous Weight and Balance Date: 09/12/2017			
Empty Weight:	Useful Load:	Empty Weight CG:	Moment:
3339.75	1230.25	86.70	289569.54

Item	Weight	Arm	Moment
G4 Insight Graphic Engine Monitor	8.40	78.40	658.56

New			
Empty Weight:	Useful Load:	Empty Weight CG:	Moment:
3348.15	1221.85	86.68	290228.10

Notes:

As Calculated:       As Weighed:       Prepared By: Kurt Dow Campbell  
 Signature: Kurt Dow Campbell  
 Printed Name: Kurt Dow Campbell  
 Repair Agency No: 3055093  
 Transonic Aviation Services  
 8661 E Hannibal St  
 Mesa AZ 85207

Form ZA-AWBR16FM

See next page for most current C.G. Diagram  
 Refer to AFM in section 9 for more details

Year	1980	1981	1982	1983	1984	1985	1986	1987	1988	1989	1990
Income											
Expenses											
Net Income											
Capital Gains											
Losses											
Other											

I hereby certify that the information furnished on this return is true and correct to the best of my knowledge and belief, and that I am a resident of the United States for the year covered by this return.

Signature: \_\_\_\_\_  
 Date: \_\_\_\_\_

This return is prepared for the year ending 12/31/80.

**TABLE OF CONTENTS**

**SECTION 7**

**DESCRIPTION AND OPERATION  
OF THE AIRPLANE AND ITS SYSTEMS**

Paragraph No.		Page No.
7.1	The Airplane . . . . .	7-1
7.3	Airframe . . . . .	7-1
7.5	Engines . . . . .	7-2
7.7	Propellers . . . . .	7-4
7.9	Landing Gear . . . . .	7-5
7.11	Brake System . . . . .	7-10
7.13	Flight Control System . . . . .	7-10
7.15	Fuel System . . . . .	7-11
7.17	Electrical System . . . . .	7-15
7.19	Gyro Pressure System . . . . .	7-19
7.21	Pitot Static System . . . . .	7-21
7.23	Instrument Panel . . . . .	7-23
7.25	Heating, Ventilating and Defrosting System . . . . .	7-25
7.27	Cabin Features . . . . .	7-28
7.29	Stall Warning . . . . .	7-29
7.31	Baggage Area . . . . .	7-29
7.33	Finish . . . . .	7-29
7.35	Emergency Locator Transmitter . . . . .	7-30
7.37	Piper External Power . . . . .	7-31
7.39	Ice Protection System . . . . .	7-31
7.41	Radar . . . . .	7-35
7.43	Air Conditioning . . . . .	7-36
7.45	Portable Oxygen System . . . . .	7-37
7.47	Fixed Oxygen System . . . . .	7-38

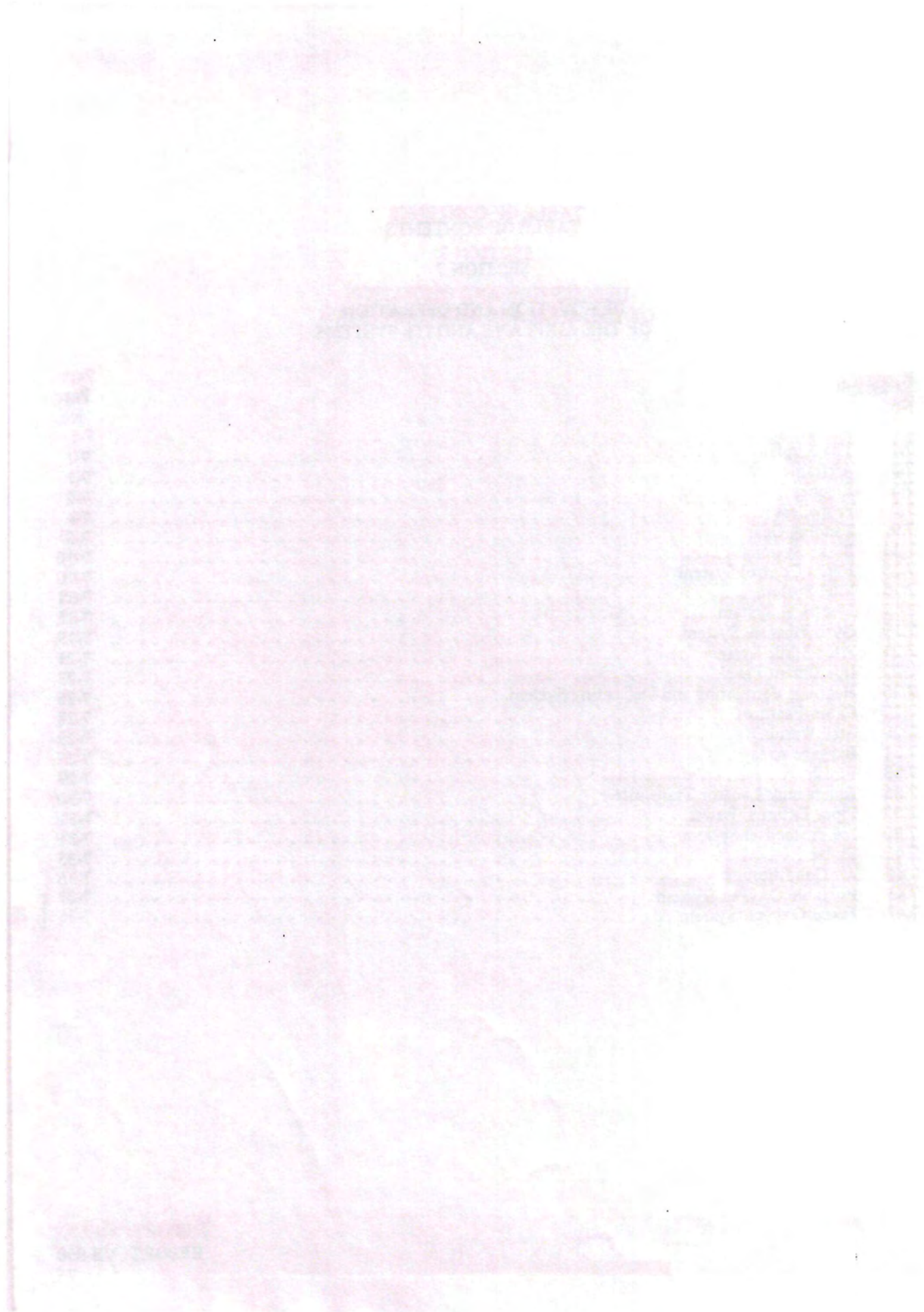

3

3

3

## SECTION 7

### DESCRIPTION AND OPERATION OF THE AIRPLANE AND ITS SYSTEMS

#### 7.1 THE AIRPLANE

The Seneca II is a twin-engine, all metal, retractable landing gear, turbocharged airplane. It has seating for up to seven occupants and two separate one hundred pound luggage compartments.

#### 7.3 AIRFRAME

With the exception of the steel engine mounts and landing gear, the fiberglass nose cone and cowling nose bowls, and the ABS thermoplastic extremities (tips of wings, tail fin, rudder and stabilator), the basic airframe is of aluminum alloy. Aerobatics are prohibited in this airplane since the structure is not designed for aerobatic loads.

The fuselage is a semi-monocoque structure. There is a front door on the right side and a rear door on the left. A cargo door is installed aft of the rear passenger door. Both rear doors may be opened for loading large pieces of cargo. A door on the left side of the nose section gives access to the nose section baggage compartment.

The wing is of a conventional design and employs a laminar flow NACA 65<sub>2</sub>-415 airfoil section. The main spar is located at approximately 40% of the chord aft of the leading edge. The wings are attached to the fuselage by the insertion of the butt ends of the spar into a spar box carry-through, which is an integral part of the fuselage structure. The bolting of the spar ends into the spar box carry-through structure, which is located under the center seats, provides in effect a continuous main spar. The wings are also attached fore and aft of the main spar by an auxiliary front spar and a rear spar. The rear spar, in addition to taking torque and drag loads, provides a mount for flaps and ailerons. The four-position wing flaps are mechanically controlled by a handle located between the front seats. When fully retracted, the right flap locks into place to provide a step for cabin entry. Each wing contains two fuel tanks as standard equipment. An optional third tank may be installed on each side. The tanks on one side are filled through a single filler neck located well outboard of the engine nacelle.

A vertical stabilizer, an all-movable horizontal stabilator, and a rudder make up the empennage. The stabilator incorporates an anti-servo tab which improves longitudinal stability and provides longitudinal trim. This tab moves in the same direction as the stabilator, but with increased travel. Rudder effectiveness is increased by an anti-servo tab on the rudder.

## 7.5 ENGINES

The Seneca II is powered by two Teledyne Continental six-cylinder turbocharged engines, each rated at 200 horsepower at 2575 RPM at sea level. The engines are air cooled and fuel injected and are equipped with oil coolers with low temperature bypass systems and engine mounted oil filters. A winterization plate is provided to restrict air during winter operation. (See Winterization in Handling and Servicing Section.) Asymmetric thrust during takeoff and climb is eliminated by the counter-rotation of the engines, the left engine rotating in a clockwise direction when viewed from the cockpit, and the right engine rotating counterclockwise.

The engines are accessible through removable panels, one on either side of each engine cowling. Engine mounts are constructed of steel tubing, and dynafocal engine mounts are provided to reduce vibration.

A Ray-Jay turbocharger on each engine is operated by exhaust gases. Exhaust gases rotate a turbine wheel, which in turn drives an air compressor. Induction air is compressed (supercharged) and distributed into the engine air manifold, and the exhaust gases which drive the compressor are discharged overboard. Engine induction air is taken from within the cowling, is filtered, and is then directed into the turbocharger compressor inlet. Each engine cylinder is supplied with pressurized air in operation from sea level to maximum operating altitude. The pressure relief valve protects the engine from inadvertently exceeding 42 inches Hg; 40 inches Hg is manually set with the throttles. The turbo bypass orifice is preset for 40 inches Hg at 12,000 feet density altitude at full throttle.

The intake filter air box incorporates a manually operated two-way valve designed to allow induction air either to pass into the compressor through the filter or to bypass the filter and supply heated air directly to the turbocharger. There is a suck in door which opens in the event that the primary air source becomes blocked. Alternate air selection insures induction air flow should the filter become blocked. Since the air is heated, the alternate air system offers protection against induction system blockage caused by snow or freezing rain, or by the freezing of moisture accumulated in the induction air filter. Alternate air is unfiltered; therefore, it should not be used during ground operation when dust or other contaminants might enter the system. The primary (through the filter) induction source should always be used for takeoffs.

The fuel injection system incorporates a metering system which measures the rate at which turbocharged air is being used by the engine and dispenses fuel to the cylinders proportionally. Fuel is supplied to the injector pump at a greater rate than the engine requires. The fuel injection system is a "continuous flow" type.

To obtain maximum efficiency and time from the engines, follow the procedures recommended in the Teledyne Continental Operator's Manual provided with the airplane.

Engine controls consist of a throttle, a propeller control and a mixture control lever for each engine. These controls are located on the control quadrant on the lower center of the instrument panel where they are accessible to both the pilot and the copilot. The controls utilize teflon-lined control cables to reduce friction and binding.

The throttle levers are used to adjust the manifold pressure. They incorporate a gear up warning horn switch which is activated during the last portion of travel of the throttle levers to the low power position. If the landing gear is not locked down, the horn will sound until the gear is down and locked or until the power setting is increased. This is a safety feature to warn the pilot of an inadvertent gear up landing.

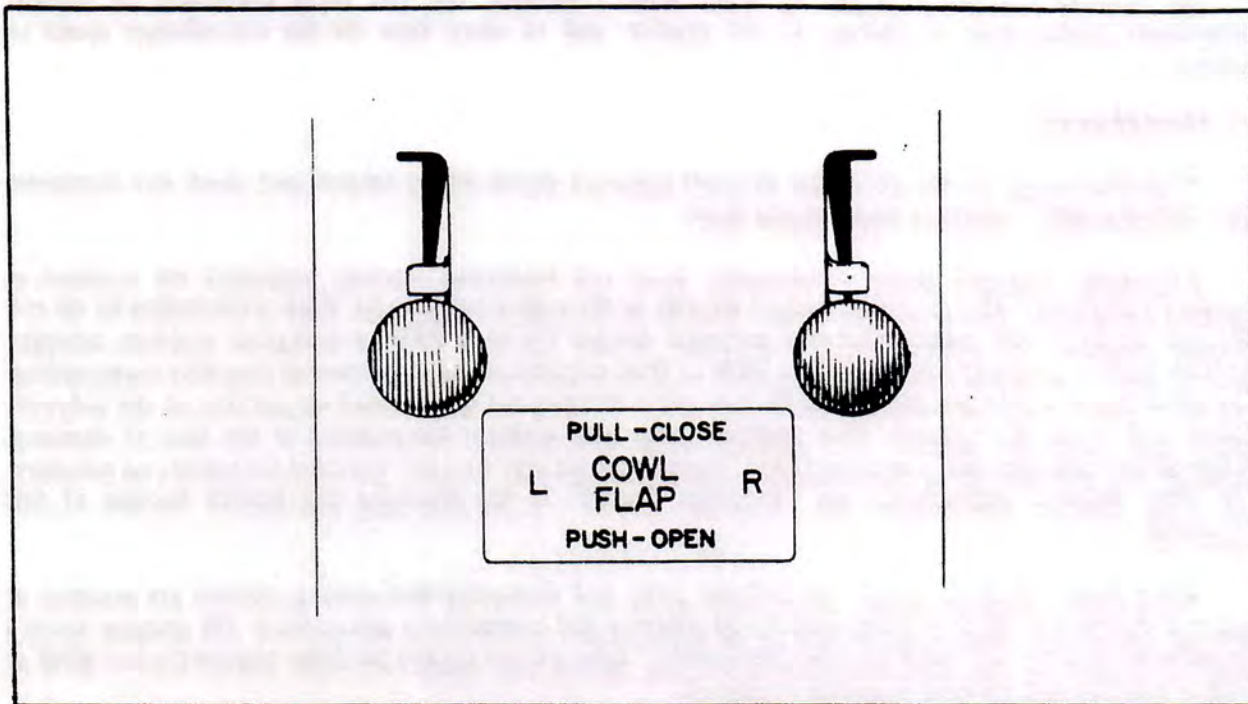

COWL FLAP CONTROL

Figure 7-1

The propeller control levers are used to adjust the propeller speed from high RPM to feather.

The mixture control levers are used to adjust the air to fuel ratio. An engine is shut down by the placing of the mixture control lever in the full lean (idle cut-off) position.

The friction adjustment lever on the right side of the control quadrant may be adjusted to increase or decrease the friction holding the throttle, propeller, and mixture controls or to lock the controls in a selected position.

The alternate air controls are located on the control quadrant just below the engine control levers. When an alternate air lever is in the up, or off, position the engine is operating on filtered air; when the lever is in the down, or on, position the engine is operating on unfiltered, heated air. Should the primary air source become blocked the suck in door will automatically select unfiltered heated air.

The cowl flap control levers (Figure 7-1), located below the control quadrant, are used to regulate cooling air for the engines. The levers have three positions: full open, full closed, and intermediate. A lock incorporated in each control lever locks the cowl flap in the selected position. To operate the cowl flaps, depress the lock and move the lever toward the desired setting. Release the lock after initial movement and continue movement of the lever. The control will stop and lock into place at the next setting. The lock must be depressed for each selection of a new cowl flap setting.

All throttle operations should be made with a smooth, not too rapid movement to prevent unnecessary engine wear or damage to the engines, and to allow time for the turbocharger speed to stabilize.

### **7.7 PROPELLERS**

Counter-rotation of the propellers provides balanced thrust during takeoff and climb and eliminates the "critical engine" factor in single engine flight.

Two-blade, constant speed, controllable pitch and feathering Hartzell propellers are installed as standard equipment. The propellers mount directly to the engine crankshafts. Pitch is controlled by oil and nitrogen pressure. Oil pressure sends a propeller toward the high RPM or unfeather position; nitrogen pressure sends a propeller toward the low RPM or feather position and also prevents propeller overspeeding. The recommended nitrogen pressure to be used when charging the unit is listed on placards on the propeller domes and inside the spinners. This pressure varies with ambient temperature at the time of charging. Although dry nitrogen gas is recommended, compressed air may be used, provided it contains no moisture. For more detailed instructions, see "Propeller Service" in the Handling and Service Section of this handbook.

Three blade, constant speed, controllable pitch and feathering McCauley propellers are available as optional equipment. Pitch is controlled by oil pressure and compression spring force. Oil pressure sends a propeller toward the high RPM or unfeather position. Spring force sends a propeller toward the low RPM or feather position and prevents propeller overspeed.

Governors, one on each engine, supply engine oil at various pressures through the propellers shafts to maintain constant RPM settings. A governor controls engine speed by varying the pitch of the propeller to match load torque to engine torque in response to changing flight conditions.

Performance data listed in Section Five of this handbook is applicable for both two and three blade propeller installations.

Each propeller is controlled by the propeller control levers located in the center of the power control quadrant. Feathering of a propeller is accomplished by moving the control fully aft through the low RPM detent, into the "FEATHER" position. Feathering takes place in approximately six seconds. Unfeathering is accomplished by moving the propeller control forward and engaging the starter until the propeller is windmilling.

A feathering lock, operated by centrifugal force, prevents feathering during engine shut down by making it impossible to feather any time the engine speed falls below 800 RPM. For this reason, when airborne, and the pilot wishes to feather a propeller to save an engine, he must be sure to move the propeller control into the "FEATHER" position before engine speed falls below 800 RPM.

A propeller synchrophaser installation is available as optional equipment. Its function is to maintain both propellers at the same RPM and at a selected phase angle. This eliminates the propeller "beat" effect and minimizes vibration. When the synchrophaser is installed, the left engine is the master engine, and the right engine is equipped with a slave governor which automatically maintains its RPM with the left engine RPM. Pulling the circuit breakers completely deactivates the propeller synchrophaser system. If the master switch is turned "OFF" or if there is an electrical system failure, the slave engine will return to the controlled selected RPM plus approximately 25 RPM "out of synchronization" regardless of the position of the synchrophaser switch.



Two different types of synchrophaser installations have been used on this aircraft. An identification and description of each system follows:

(a) Propeller Synchrophaser with fixed phase angle.

When this synchrophaser is installed a two-position switch is located on the throttle quadrant below the propeller controls. It is labeled "MANUAL" for manual control or standby and "AUTO SYNC" for propeller synchrophaser.

The propeller synchrophaser switch must be in the "MANUAL" position during taxi, takeoff, landing and single engine operations. During cruise, propellers should be synchronized manually to within approximately 30 RPM and the switch placed in the "AUTO SYNC" position. Normally, propeller synchrophasing will take place within a few seconds, but occasionally it may take up to a full minute. When changing power settings the synchrophaser switch should be set to "MANUAL" for 30 seconds before the power setting is adjusted; then the synchrophaser may be returned to the "AUTO SYNC" position. If the propeller RPM differential exceeds 50 RPM, the switch should be placed on "MANUAL" for 30 to 40 seconds; then the propellers can be synchronized again and the synchrophaser switch returned to "AUTO SYNC".

(b) Propeller Synchrophaser with adjustable phase angle.

When this synchrophaser is installed, a rotary switch is located on the throttle quadrant below the propeller controls. It is labeled "OFF" for manual control or standby and "PHASE ADJUSTMENT" for propeller synchronizing and phase angle adjustment.

The rotary switch must be in the "OFF" position during taxi, takeoff, landing and single engine operations. Before operating the synchrophaser system, insure that the rotary switch is in the "OFF" position and manually synchronize the propellers to within 40 RPM. To operate, rotate the switch clockwise out of the "OFF" detent and slightly into the "PHASE ADJUSTMENT" range. It may require up to 30 seconds for the propellers to synchronize. The phase angle of the propellers may then be adjusted by rotating the switch within the "PHASE ADJUSTMENT" range to obtain the smoothest operation. Remember to wait 30 seconds after any switch movement for the propellers to assume the new phase angle. Turn the synchrophaser switch to the "OFF" position for 30 seconds before changing power settings; re-establish synchrophaser operation following power changes using the above procedure.

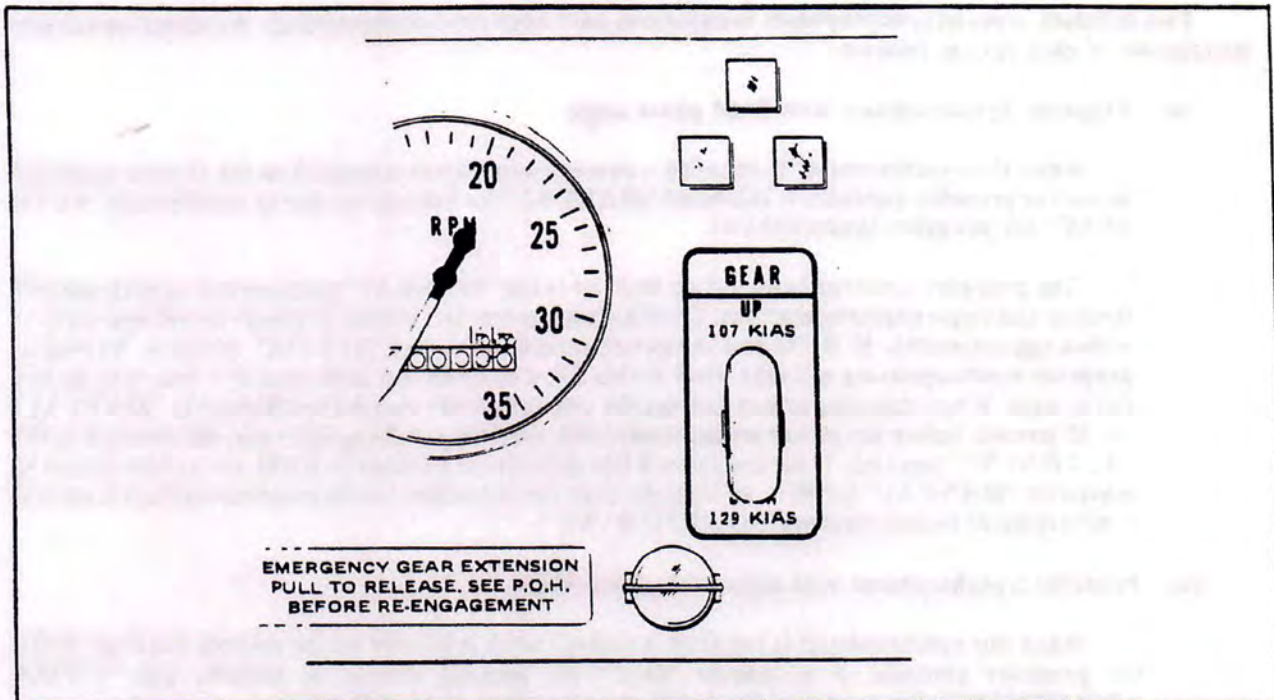

LANDING GEAR SELECTOR

Figure 7-3

### 7.9 LANDING GEAR

The Seneca II is equipped with hydraulically operated, fully retractable, tricycle landing gear.

Hydraulic pressure for gear operation is furnished by an electrically powered, reversible hydraulic pump (refer to Figures 7-5 and 7-7). The pump is activated by a two-position gear selector switch located to the left of the control quadrant on the instrument panel (Figure 7-3). The gear selector switch, which has a wheel-shaped knob, must be pulled out before it is moved to the "UP" or "DOWN" position. When hydraulic pressure is exerted in one direction, the gear is retracted; when it is exerted in the other direction, the gear is extended. Gear extension or retraction normally takes six to seven seconds.

#### CAUTION

If the landing gear is in transit, and the hydraulic pump is running, it is NOT advisable to move the gear selector switch to the opposite position before the gear has reached its full travel limit, because a sudden reversal may damage the electric pump.

The landing gear is designed to extend even in the event of hydraulic failure. Since the gear is held in the retracted position by hydraulic pressure, should the hydraulic system fail for any reason, gravity will allow the gear to extend. When the landing gear is retracted, the main wheels retract inboard into the wings and the nose wheel retracts forward into the nose section. Aerodynamic loads and springs assist in gear

extension and in locking the gear in the down position. During gear extension, once the nose gear has started toward the down position, the airstream pushes against it and assists in moving it to the downlocked position. After the gears are down and the downlock hooks engage, springs maintain force on each hook to keep it locked until it is released by hydraulic pressure.

To extend and lock the gears in the event of hydraulic failure, it is necessary only to relieve the hydraulic pressure. Emergency gear extension must not be attempted at airspeeds in excess of 84 KIAS. An emergency gear extension knob, located directly beneath the gear selector switch is provided for this purpose. Pulling this knob releases the hydraulic pressure holding the gear in the up position and allows the gear to fall free. During normal operation, this knob is covered by a guard to prevent inadvertent extension of the gear. Before pulling the emergency gear extension knob, place the landing gear selector switch in the "DOWN" position to prevent the pump from trying to raise the gear. If the emergency gear knob has been pulled out to lower the gear by gravity, due to a gear system malfunction, leave the control in its extended position until the airplane has been put on jacks to check the proper function of the landing gears hydraulic and electrical systems. See Aircraft Service Manual for proper landing gear system check out procedures. If the airplane is being used for training purposes or a pilot check out mission, and the emergency gear extension has been pulled out, it may be pushed in again when desired if there has not been any apparent malfunction of the landing gear system.

When the gear is fully extended or fully retracted and the gear selector is in the corresponding position, electrical limit switches stop the flow of current to the motor of the hydraulic pump. The three green lights directly above the landing gear selector switch illuminate to indicate that each of the three landing gears is down and locked. A convex mirror on the left engine nacelle both serves as a taxiing aid and allows the pilot to visually confirm the condition of the nose gear. If the gear is in neither the full up nor the full down position, a red warning light on the instrument panel illuminates. Should the throttle be placed in a low setting - as for a landing approach - while the gear is retracted, a warning horn sounds to alert the pilot that the gear is retracted. The gear warning horn emits a 90 cycles per minute beeping sound.

The green gear lights are dimmed automatically when the navigation lights are turned on. For this reason, if the navigation lights are turned on in the daytime, it is difficult to see the landing gear lights. If the green lights are not observed after the landing gear selector switch is placed in the "DOWN" position, the first thing to check is the position of the navigation lights switch.

If one or two of the three green lights do not illuminate when the gear down position has been selected, any of the following conditions could exist for each light that is out:

- (a) The gear is not locked down.
- (b) A bulb is burned out.
- (c) There is a malfunction in the indicating system.

In order to check the bulbs, the square indicator lights can be pulled out and interchanged.

A micro switch incorporated in the throttle quadrant activates the gear warning horn under the following conditions:

- (a) The gear is not locked down and the manifold pressure has fallen below 14 inches on either one or both engines.
- (b) The gear selector switch is in the "UP" position when the airplane is on the ground.

To prevent inadvertent gear retraction should the gear selector switch be placed in the "UP" position when the airplane is on the ground, a squat switch located on the left main gear will prevent the hydraulic pump from actuating if the master switch is turned on. On takeoff, when the landing gear oleo strut drops to its full extension, the safety switch closes to complete the circuit which allows the hydraulic pump to be activated to raise the landing gear when the gear selector is moved to the "UP" position. During the

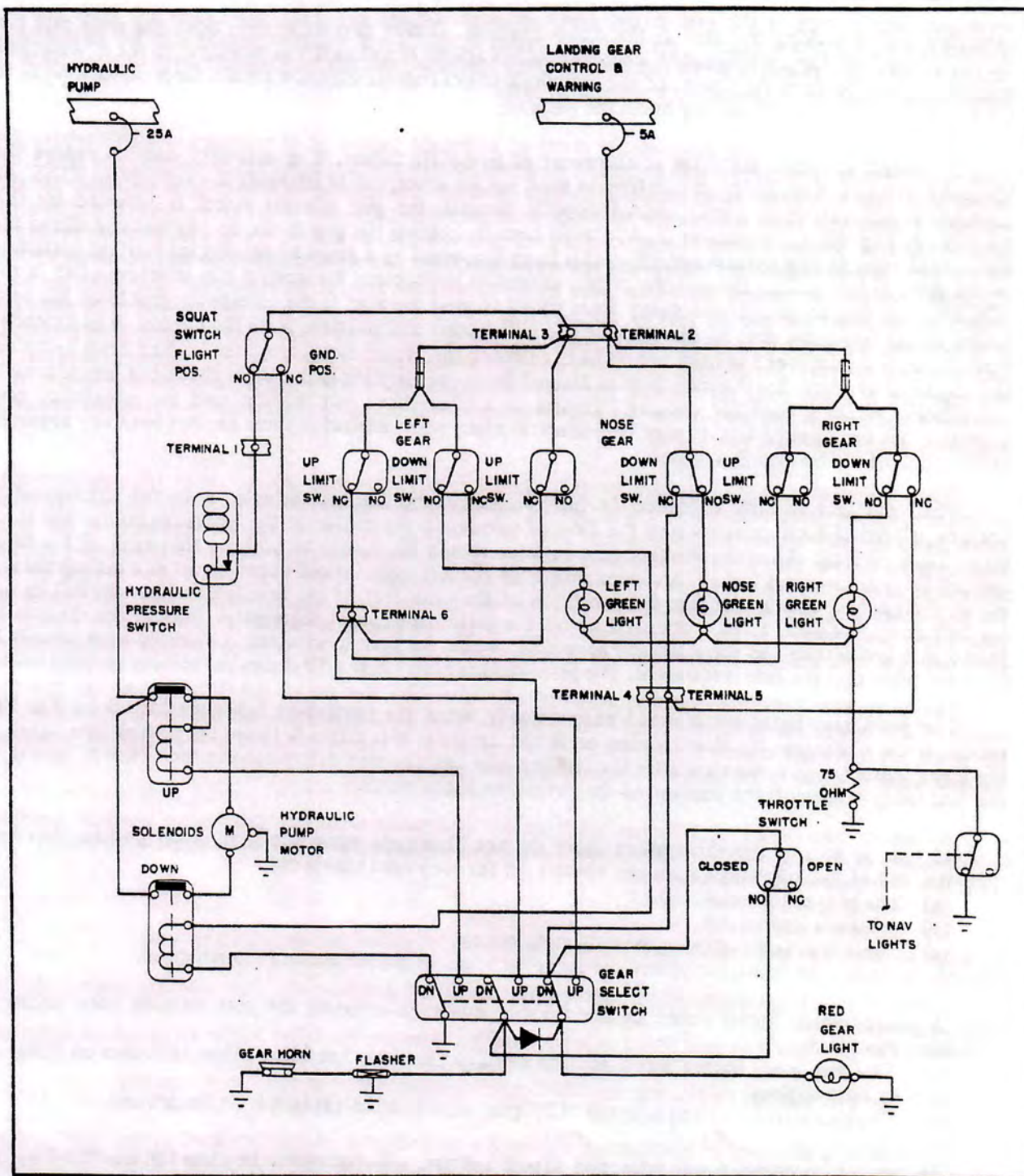

LANDING GEAR ELECTRICAL SYSTEM SCHEMATIC

Figure 7-5

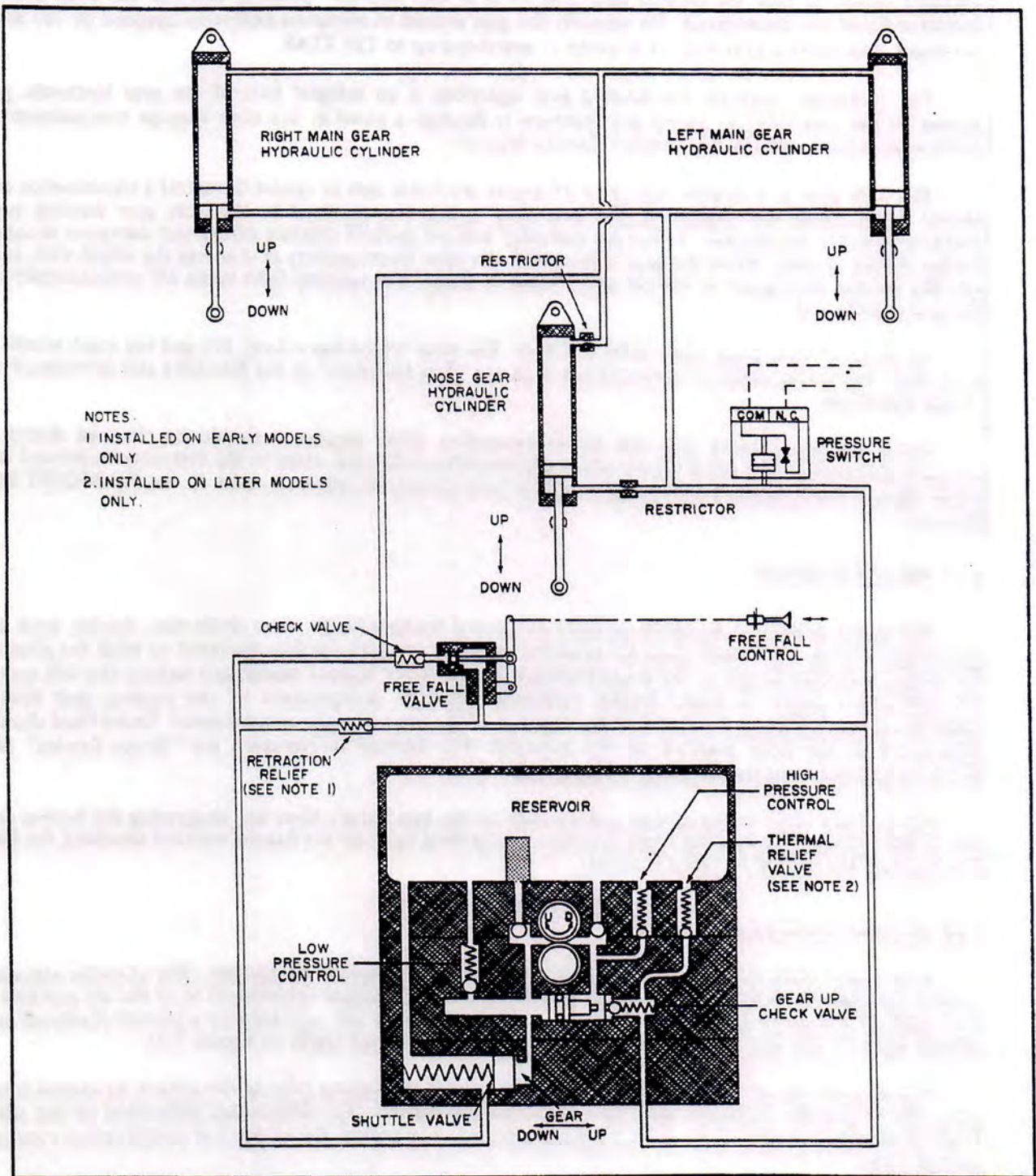

LANDING GEAR HYDRAULIC SYSTEM SCHEMATIC

Figure 7-7

preflight check, be sure the landing gear selector is in the "DOWN" position and that the three green gear indicator lights are illuminated. On takeoff, the gear should be retracted before an airspeed of 107 KIAS is exceeded. The landing gear may be lowered at any speed up to 129 KIAS.

The hydraulic reservoir for landing gear operation is an integral part of the gear hydraulic pump. Access to the combination pump and reservoir is through a panel in the nose baggage compartment. For filling instructions, see the PA-34-200T Service Manual.

The nose gear is steerable through a 27 degree arc either side of center by use of a combination of full rudder pedal travel and brakes. A gear centering spring, incorporated in the nose gear steering system, prevents shimmy tendencies. A bungee assembly reduces ground steering effort and dampens shocks and bumps during taxiing. When the gear is retracted, the nose wheel centers as it enters the wheel well, and the steering linkage disengages to reduce pedal loads in flight. The landing light turns off automatically when the gear is retracted.

All three landing gears carry 6.00 x 6 tires. The nose wheel has a 6-ply tire and the main wheels have 8-ply tires. For information on servicing the tires, see "Tire Inflation" in the Handling and Servicing Section of this Handbook.

Struts for the landing gear are air-oil assemblies. Strut exposure should be checked during each preflight inspection. If a need for service or adjustment is indicated, refer to the instructions printed on the units. Should more detailed landing gear service information be required, refer to the PA-34-200T Service Manual.

#### 7.11 BRAKE SYSTEM

The brake system is designed to meet all normal braking needs. Two single-disc, double puck brake assemblies, one on each main gear, are actuated either by toe brake pedals mounted on both the pilot's and the copilot's rudder pedals or by a hand-operated brake lever located below and behind the left center of the instrument panel. A brake system hydraulic reservoir, independent of the landing gear hydraulic reservoir, is located behind a panel in the rear top of the nose baggage compartment. Brake fluid should be maintained at the level marked on the reservoir. For further information see "Brake Service" in the Handling and Servicing Section of this Handbook.

The parking brake is engaged by pulling back on the hand brake lever and depressing the button on the left of the handle. The parking brake is released by pulling back on the handle without touching the button and allowing the handle to swing forward.

#### 7.13 FLIGHT CONTROL SYSTEM

Dual flight controls are installed in the Seneca II as standard equipment. The controls actuate the control surfaces through a cable system. The horizontal tail surface (stabilator) is of the all movable slab type with an anti-servo tab mounted on the trailing edge. This tab, actuated by a control mounted on the console between the front seats, also acts as a longitudinal trim tab (refer to Figure 7-9).

The ailerons are of the Frise type. This design allows the leading edge of the aileron to extend into the airstream to provide increased drag and improved roll control. The differential deflection of the ailerons tends to eliminate adverse yaw in turning maneuvers and to reduce the amount of coordination required in normal turns.

The vertical tail is fitted with a rudder which incorporates a combination rudder trim and anti-servo tab. The rudder trim control is located on the control console between the front seats.

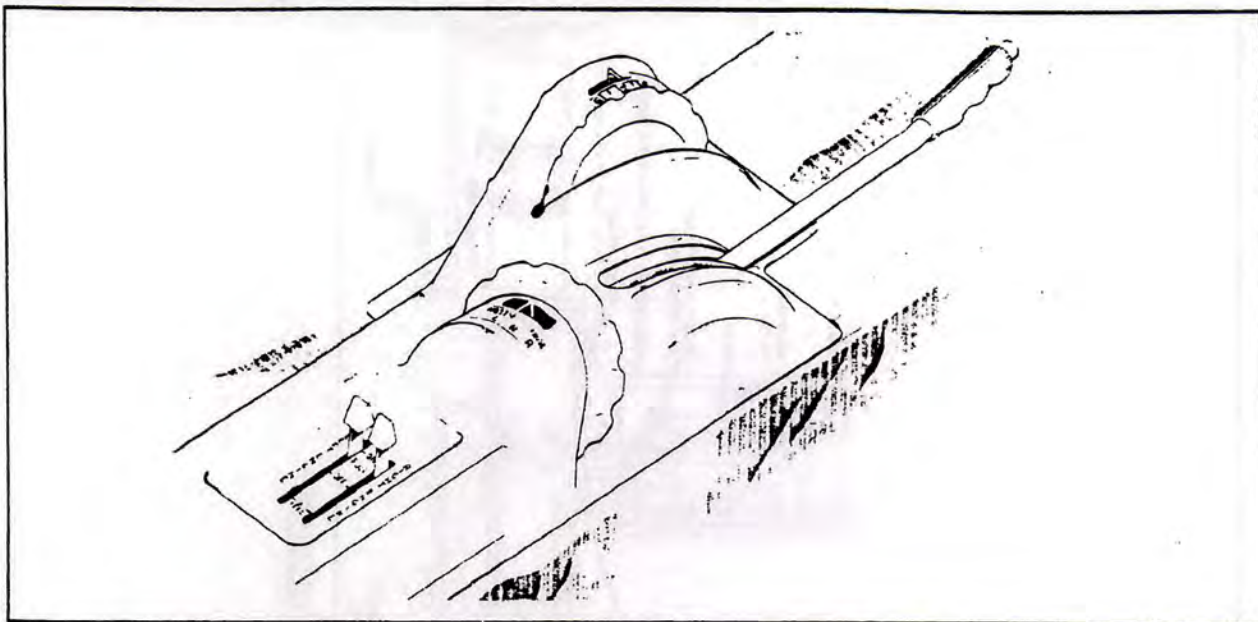

**CONSOLE**

Figure 7-9

The flaps are manually operated and spring loaded to return to the retracted position. A four-position flap control lever (Figure 7-9) between the front seats adjusts the flaps for reduced landing speeds and glide path control. The flaps have three extended positions - 10, 25 and 40 degrees - as well as the fully retracted position. A button on the end of the lever must be depressed before the control can be moved. A past center lock incorporated in the actuating linkage holds the flap when it is in the retracted position so that it may be used as a step on the right side. Since the flap will not support a step load except in the fully retracted position, the flaps should be retracted when people are entering or leaving the airplane.

#### 7.15 FUEL SYSTEM

Fuel is stored in fuel tanks located in each wing. The tanks in each wing are interconnected to function as a single tank (refer to Figure 7-11). All tanks on a side are filled through a single filler in the outboard tank, and as fuel is consumed from the inboard tank, it is replenished by fuel from outboard. Only two and one half gallons of fuel in each wing is unusable, giving the Seneca II a total of 93 usable gallons with standard fuel tanks or 123 usable gallons with the optional fuel tanks installed. The minimum fuel grade is 100 or 100LL aviation grade. The fuel tank vents, one installed under each wing, feature an anti-icing design to prevent ice formation from blocking the fuel tank vent lines.

The fuel injection system is a "continuous flow" type which utilizes a vapor return line leading back to the fuel tanks. This line provides a route back to the tanks for vapor laden fuel that has been separated in the injector pump swirl chamber. Each engine has an engine driven fuel pump that is a part of the fuel injection system. An auxiliary fuel system is provided. The purpose of the electrically powered auxiliary fuel system is to supply fuel to the engine in case of engine driven fuel pump shaft failure or malfunction, for ground and inflight engine starting, and for vapor suppression. The two auxiliary fuel pump switches are located on the electrical side panel and are three position rocker switches; LO, HI and OFF. The LO auxiliary fuel pressure is selected by pushing the top of the switch. The HI auxiliary fuel pressure is selected by pushing the bottom of the switch, but this can be done only after unlatching the adjacent guard. When the HI auxiliary fuel pump is activated, an amber light near the annunciation panel is illuminated for each pump. These lights dim whenever the pump pressure reduces automatically and manifold pressure is below approximately 21 inches.

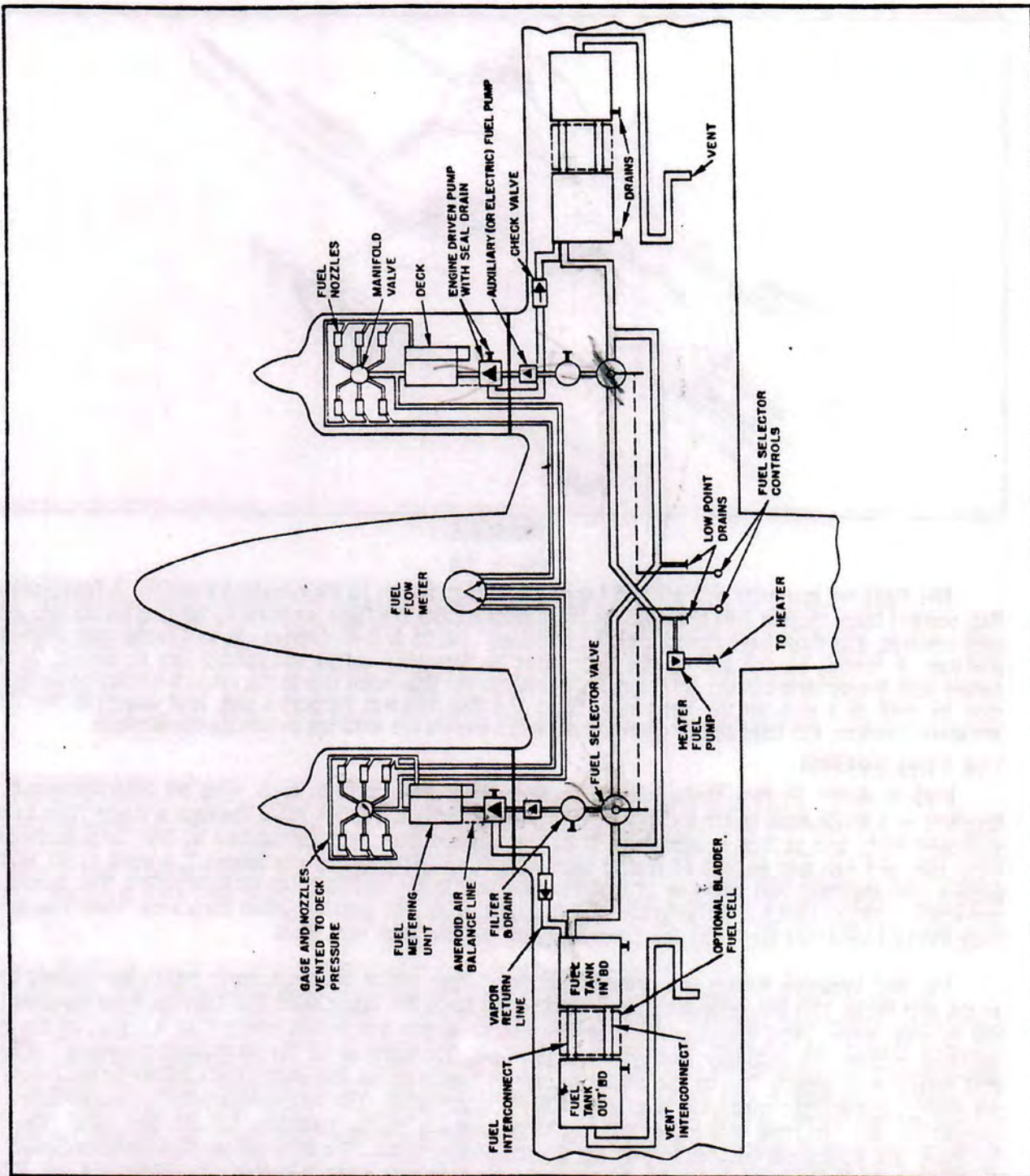

FUEL SYSTEM SCHEMATIC

Figure 7-11



In case of a failed engine-driven fuel pump, auxiliary fuel pressure should be selected. Adequate pressure and fuel flow will be supplied for up to approximately 75% power. Manual leaning to the correct fuel flow will be required at altitudes above 15,000 feet and for engine speeds less than 2300 RPM. An absolute pressure switch automatically selects a lower fuel pressure when the throttle is reduced below 21" Hg manifold pressure and the HI auxiliary fuel pump is on.

NOTE

Excessive fuel pressure and very rich fuel/air mixtures will occur if the HI position is energized when the engine fuel injection system is functioning normally.

Low auxiliary fuel pressure is available and may be used during normal engine operation both on the ground and in flight for vapor suppression should it be necessary as evidenced by unstable engine operation or fluctuating fuel flow indications during idle or at high altitudes.

Separate spring loaded OFF primer button switches, located adjacent to the starter switches are used to select HI auxiliary fuel pump operation for priming, irrespective of other switch positions. These primer buttons may be used for both hot or cold engine starts.

On airplanes equipped with an optional engine primer system (identified by Placard below starter switch shown in Figure 7-15), the primer switch location and actuation is the same as the basic airplane. However, this system does provide a separate primer system as an integral part of the engine fuel system. An electrically operated diverter valve is located in the metered fuel supply line between the air throttle valve and the manifold valve. Other components are two primer nozzles, located in the intake manifold on each side of the engine, the interconnecting fuel lines, and fine wire spark plugs. Actuation of the engine primer switch operates the auxiliary electric fuel pump on HI and energizes the diverter valve which supplies fuel to each primer nozzle. The diverter valve does not shut off fuel flow to the manifold valve, therefore some quantity of fuel is also supplied to each cylinder nozzle during priming. Normal operation of the auxiliary fuel pump is unchanged.

Fuel management controls are located on the console between the front seats. There is a control lever for each of the engines, and each is placarded "ON" - "OFF" - "X FEED." During normal operation, the levers are in the "ON" position, and each engine draws fuel from the tanks on the same side as the engine. The two fuel systems are interconnected by crossfeed lines. When the "X FEED" position is selected, the engine will draw fuel from the tanks on the opposite side in order to extend range and keep fuel weight balanced during single-engine operation. The "OFF" position shuts off the fuel flow from a side.

NOTE

When one engine is inoperative and the fuel selector for the operating engine is on "X FEED" the selector for the inoperative engine must be in the "OFF" position. Do not operate with both selectors on "X FEED." Do not take off with a selector on "X FEED." Fuel and vapor are always returned to the tank on the same side as the operating engine.

Before each flight, fuel must be drained from low points in the fuel system to ensure that any accumulation of moisture or sediment is removed from the system. Fuel drains are provided for each fuel filter (2), each fuel tank (4), and each crossfeed line (2). The fuel filter drains are located on the outboard underside of each engine nacelle; two fuel tank drains are located on the underside of each wing; fuel crossfeed drains are located at the lowest point in the fuel system, on the underside of the fuselage, just inboard of the trailing edge of the right wing flap.

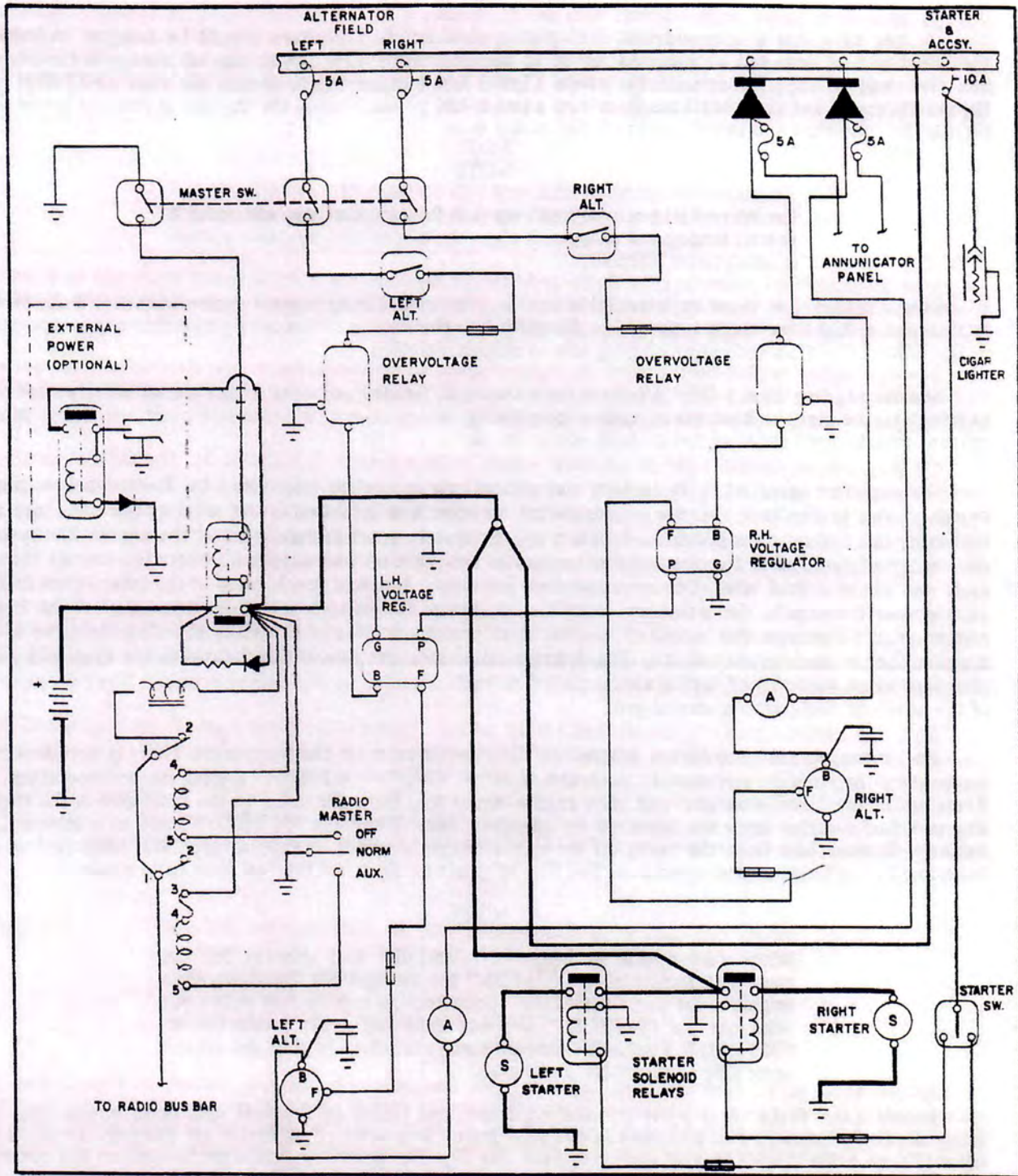

ALTERNATOR AND STARTER SCHEMATIC

Figure 7-13

### 7.17 ELECTRICAL SYSTEM

The electrical system of the Seneca II is capable of supplying sufficient current for complete night IFR equipment. Electrical power is supplied by two 65 ampere alternators (Figure 7-13), one mounted on each engine. A 35 ampere-hour, 12-volt battery provides current for starting, for use of electrical equipment when the engines are not running, and for a source of stored electrical power to back up the alternator output. The battery, which is located in the nose section and is accessible through the forward baggage compartment, is normally kept charged by the alternators. If it becomes necessary to charge the battery, it should be removed from the airplane.

An optional starting installation known as Piper External Power (PEP) is accessible through a receptacle located on the lower left side of the nose section. An external battery can be connected to the socket, thus allowing the operator to crank the engine without having to gain access to the airplane's battery.

Two solid state voltage regulators maintain effective load sharing while regulating electrical system bus voltage to 14-volts. An overvoltage relay in each alternator circuit prevents damage to electrical and avionics equipment by taking an alternator off the line if its output exceeds 14-volts. If this should occur, the alternator light on the annunciator panel will illuminate. Voltage regulators and overvoltage relays are located forward of the bottom of the bulkhead separating the cabin section from the nose section.

Approximately 2000 RPM or more is required to obtain full alternator output of 65 amperes. It is normal to have zero output at idle RPM. This is due to the reduced drive ratio from the engine. Dual ammeters and the ALT annunciator light provide a means of monitoring the electrical system operation. The two ammeters (load meters) indicate the output of the alternators. Should an ammeter indicate a load much higher than the known consumption of the electrical equipment in use, it should be suspected of a malfunction and turned off. In this event, the remaining alternator's ammeter should show a normal indication after approximately one minute. If both ammeters indicate a load much higher than the known consumption for more than approximately five minutes, an electrical defect other than the alternator system should be suspected because a discharged battery will reduce the alternator load as it approaches the charged conditions. A zero ammeter reading indicates an alternator is not producing current and should be accompanied by illumination of the ALT annunciator light. A single alternator is capable of supporting a continued flight in case of alternator or engine failure in most conditions; however, with deicing equipment and other high loads, care must be exercised to prevent the loads from exceeding the 65 ampere rating and subsequent depletion of the battery.

The annunciator panel on the upper left of the instrument panel is installed as an electrical accessory. It includes manifold pressure overboost, gyro pressure, oil pressure, and alternator indicator lights. Illumination of any light indicates that the pilot should monitor system gauges to determine if a failure has occurred and if corrective action is required. Light function may be tested with a "push to test" switch. In addition an amber light illuminates when the corresponding HI auxiliary fuel pump is energized. The auxiliary fuel pump annunciator lights will not illuminate when the "push to test" switch is actuated. Auxiliary fuel system light function is tested when the primer switches are actuated.

When all electrical equipment is turned off (except the master switch), the ammeters will indicate current being used to charge the battery and operate the instruments. If the sum of the two readings is significant, this is an indication that the battery has a low charge. The pilot should try to determine why it is low, and if no cause is apparent, the condition of the battery and the electrical system should be checked by a mechanic.

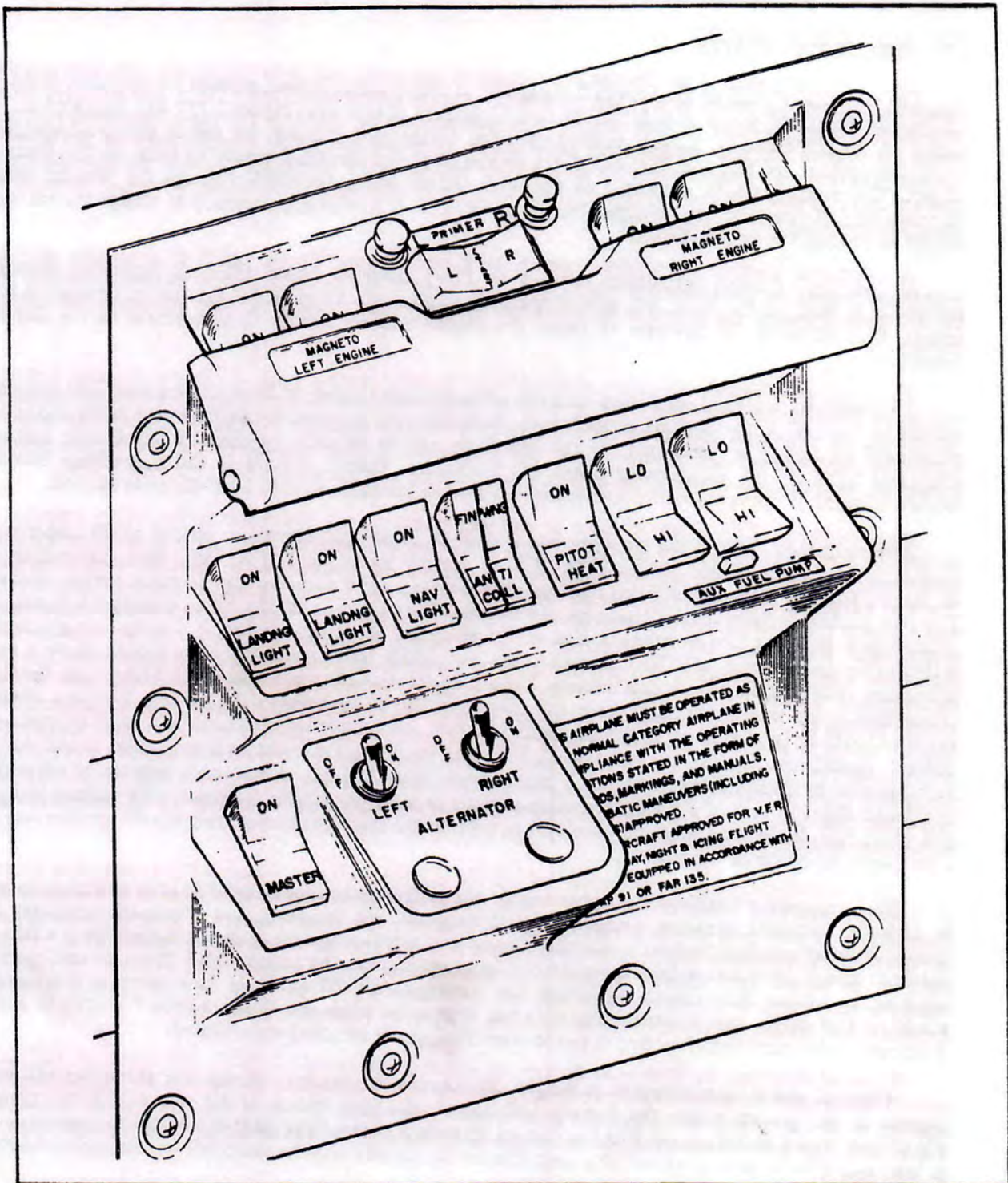

SWITCH PANEL - WITH PRIMER SYSTEM

Figure 7-15

If both alternators should fail during flight, the battery becomes the only source of electrical power; therefore, all unnecessary electrical equipment should be turned off. The length of time the battery will be able to supply power to the necessary equipment depends on the current drained by the equipment, the time it took for the pilot to notice the dual failure and to execute protective procedures, and the condition of the battery.

During night or instrument flight, the pilot should continuously monitor the ammeters and warning light so that prompt corrective action may be initiated if an electrical malfunction occurs. Procedures for dealing with electrical malfunction are covered in detail in the Emergency Procedures Section.

The electrical system and equipment are protected by circuit breakers located on a circuit breaker panel on the lower right side of the instrument panel. The circuit breaker panel is provided with enough blank spaces to accommodate additional circuit breakers if extra electrical equipment is installed. In the event of equipment malfunctions or a sudden surge of current, a circuit breaker can trip automatically. The pilot can reset the breaker by pressing it in (preferably after a few minutes cooling period). The circuit breakers can be pulled out manually.

Most of the electrical switches, including the master switch and switches for magnetos, fuel pumps, starters, alternators, lights and pitot heat, are conveniently located on the switch panel (Figure 7-15) to the left of the pilot.

#### WARNING

Strobe lights should not be operating when flying through overcast and clouds since reflected light can produce spacial disorientation. Do not operate strobe lights in close proximity to ground, during takeoff and landing.

An optional cabin courtesy light system consists of a front entrance light over the forward cabin door and a rear entrance light which replaces the reading light over the aft cabin door. These lights are operated individually with switches which are incorporated as part of each light assembly. The courtesy light circuit is independent of the aircraft master switch; therefore, the lights can be operated regardless of the position of the master switch. Unless the engines are running, the courtesy lights should not be left on for extended time periods, as battery depletion could result.

Two standard red lights, mounted in the overhead panel, provide instrument and cockpit lighting for night flying. The lights are controlled by rheostat switches located adjacent to each light. A white map light window in the lens is actuated by an adjacent switch.

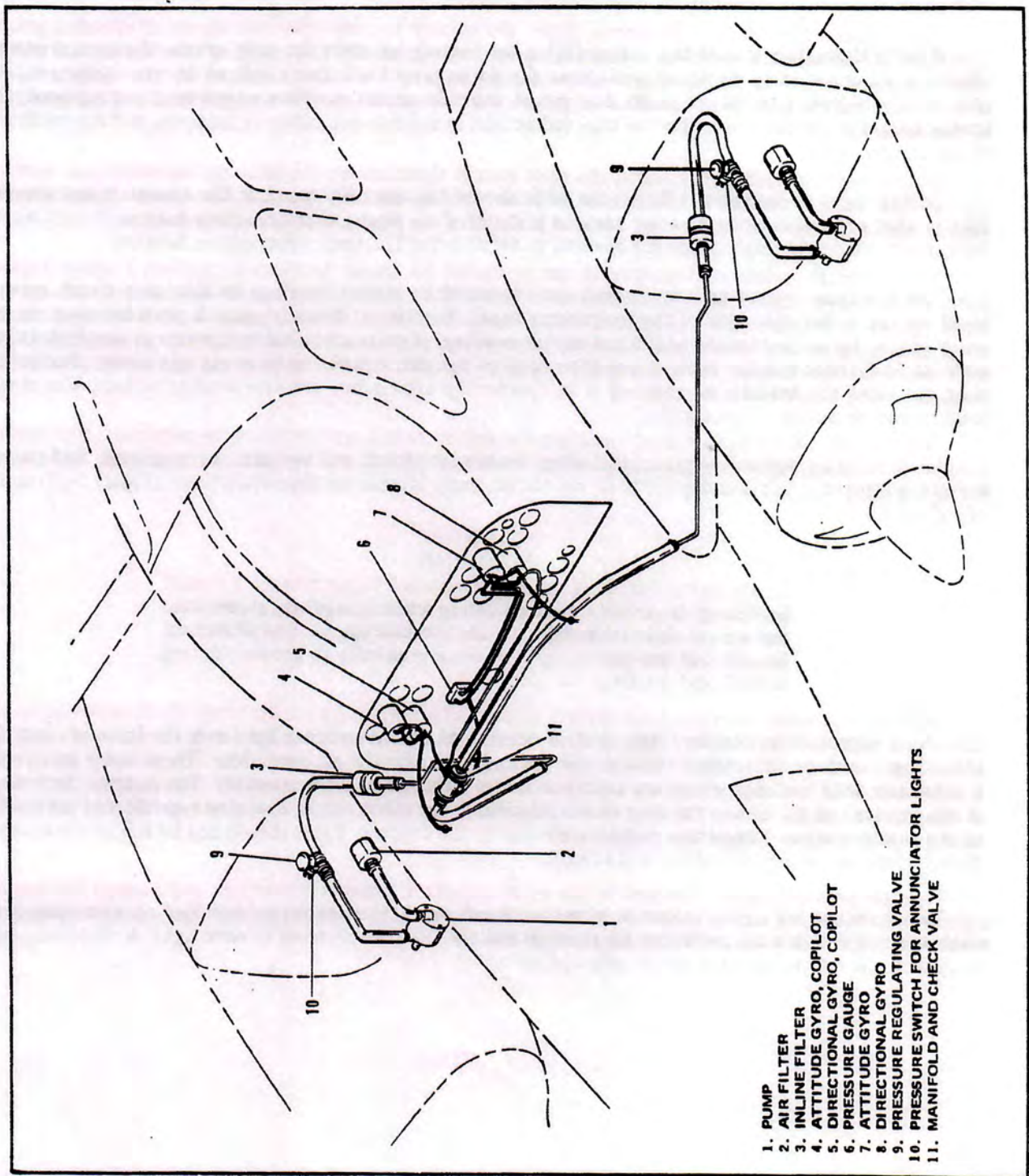

**GYRO PRESSURE SYSTEM**

Figure 7-17

### 7.19 GYRO PRESSURE SYSTEM

The directional gyros and attitude indicators are driven by positive air pressure. The pressure system (Figure 7-17) consists of a pressure pump on each engine, plus plumbing and regulating equipment. Air for the system is taken from the engine nacelle area through inlet filters and passed through pressure pumps installed on the engines. Pressure regulators mounted on the fire walls maintain the air at constant pressure to prevent damage to the instruments. An inline filter is located in each nacelle. Check valves and a pressure air manifold are mounted in the cabin at the forward bulkhead. The check valves close to allow pressure instruments to function during single-engine operation or in the event of malfunction of one of the pressure pumps. The instruments receive air from the manifold. A pressure gauge on the instrument panel, to the left of the copilot's control wheel shaft, is connected to the manifold and indicates the pressure the gyros are receiving. After air has passed through the gyro instruments, it is exhausted overboard through the forward bulkhead.

The operating limits for the gyro pressure system are 4.5 to 5.2 inches of mercury for all operations. Operation of the gyro pressure system can be monitored through a gyro pressure gauge mounted to the left of the copilot's control wheel. The two warning indicators mounted on the gauge serve to alert the pilot should one of the engines be producing less than sufficient pressure to operate the gyro instruments. Additional warning of a possible malfunction in the gyro pressure system is provided by a light in the annunciator panel.

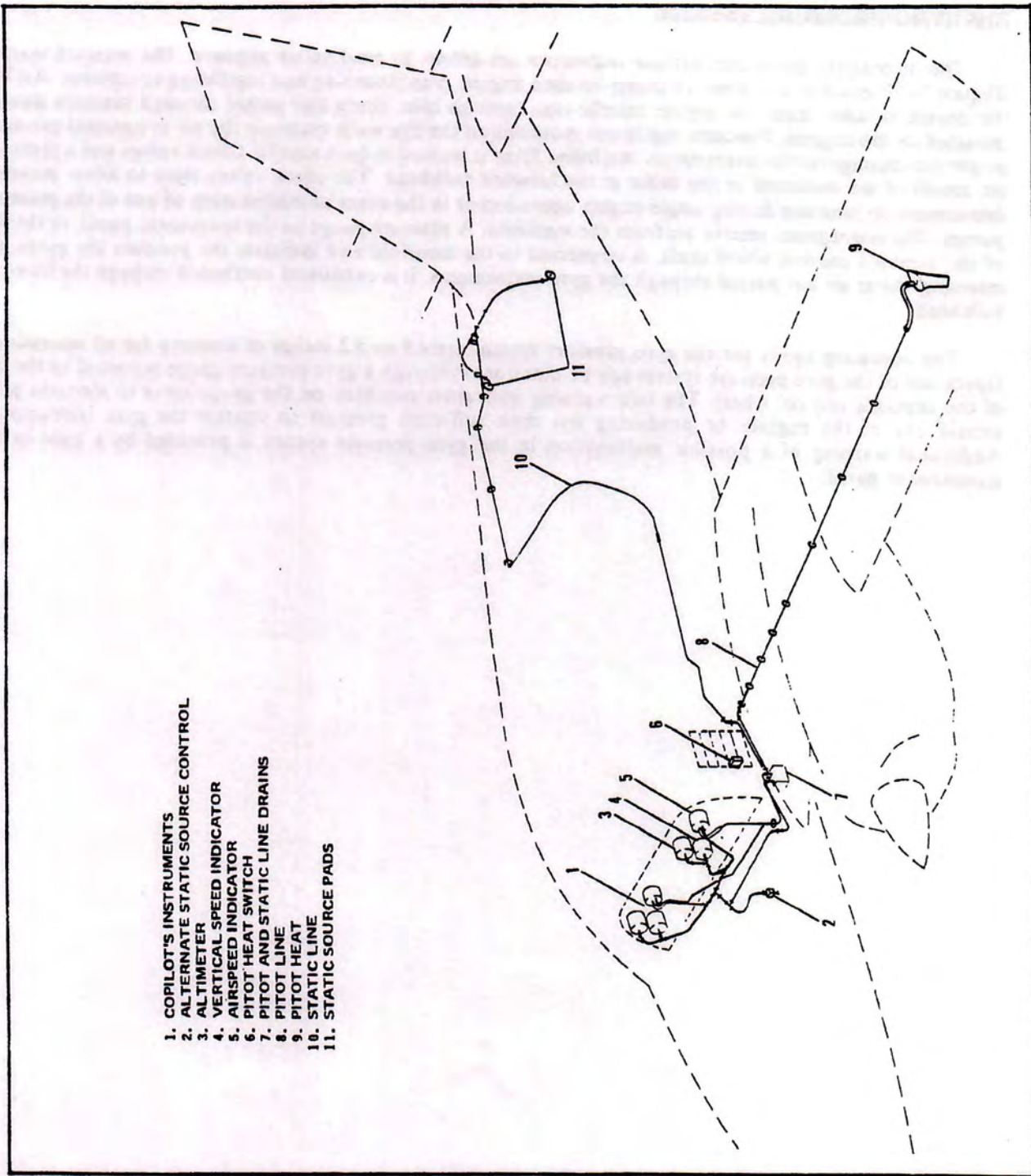

PITOT STATIC SYSTEM

Figure 7-19



### 7.21 PITOT STATIC SYSTEM

Pitot pressure for the airspeed indicator is sensed by an aluminum pitot head installed on the bottom of the left wing and carried through lines within the wing and fuselage to the gauge on the instrument panel (refer to Figure 7-17). Static pressure for the altimeter, vertical speed and airspeed indicators is sensed by two static source pads, one on each side of the rear fuselage forward of the stabilator. They connect to a single line leading to the instruments. The dual pickups balance out differences in static pressure caused by side slips or skids.

An alternate static source control valve is located below the instrument panel to the right of the control quadrant. When the valve is set to the alternate position, the altimeter, vertical speed indicator and airspeed indicator will be using cabin air for static pressure. During alternate static source operation, these instruments may give slightly different reading, depending on conditions within the cabin. Airspeed, setting of heating and ventilating controls, or the position of the storm window can influence cabin air pressure. The pilot can determine the effects of the alternate static source on instrument readings by switching from standard to alternate sources at different airspeeds and heating and ventilating configurations (including open storm window below 129 KIAS).

If one or more of the pitot static instruments malfunction, the system should be checked for dirt, leaks, or moisture. The pitot and the static lines may be drained through separate drains located on the side panel next to the pilot's seat.

The holes in the sensors for pitot and static pressure must be fully open and free from dirt, bugs, or polish. Blocked sensor holes will give erratic or zero readings on the instruments.

A heated pitot head, which alleviates problems with icing and heavy rain, is available as optional equipment. Static source pads have been demonstrated to be non-icing; however, in the event icing does occur, selecting the alternate static source will alleviate the problem.

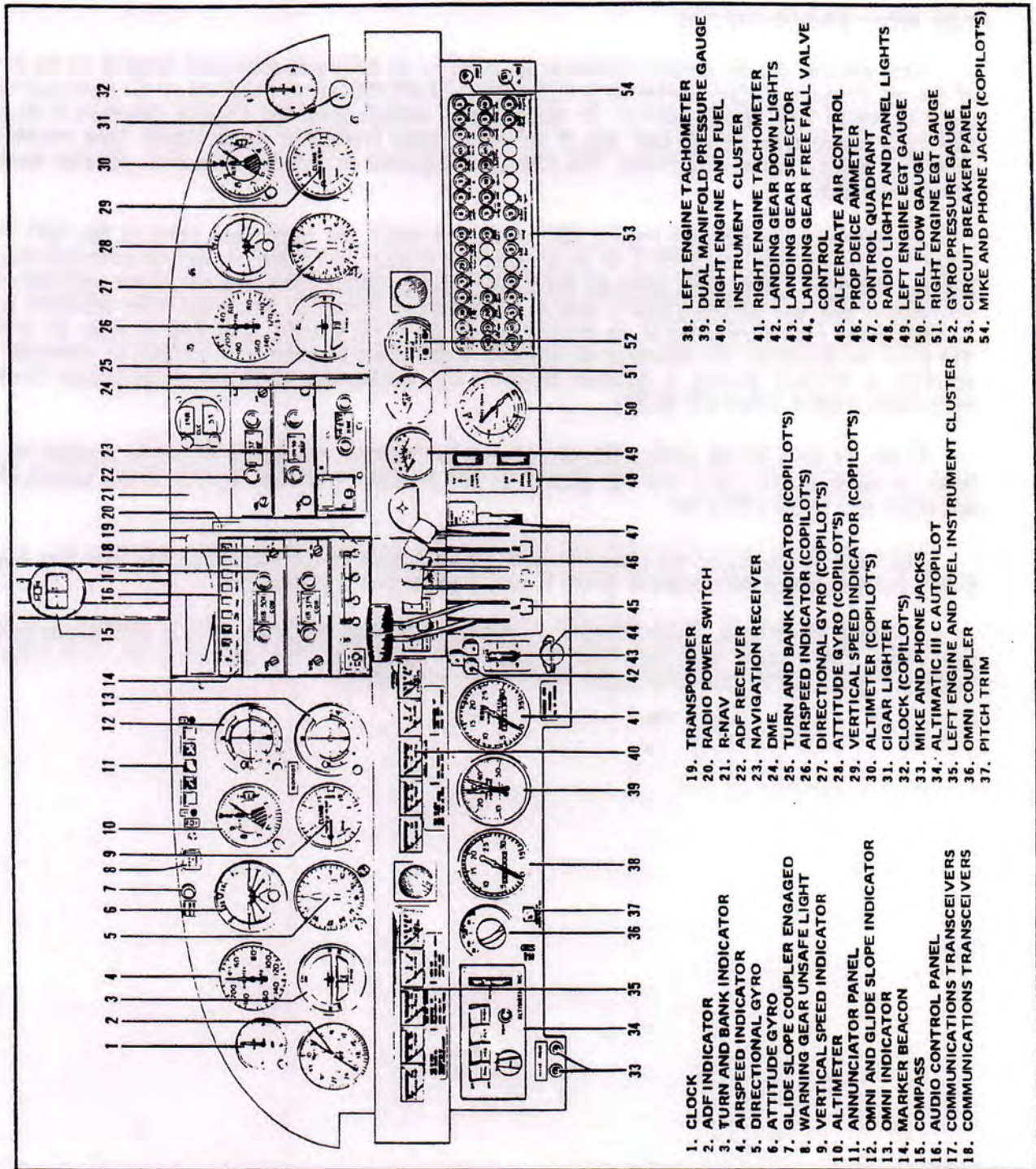

INSTRUMENT PANEL (SERIAL NUMBERS 34-7770001 THROUGH 34-7870474)

Figure 7-21

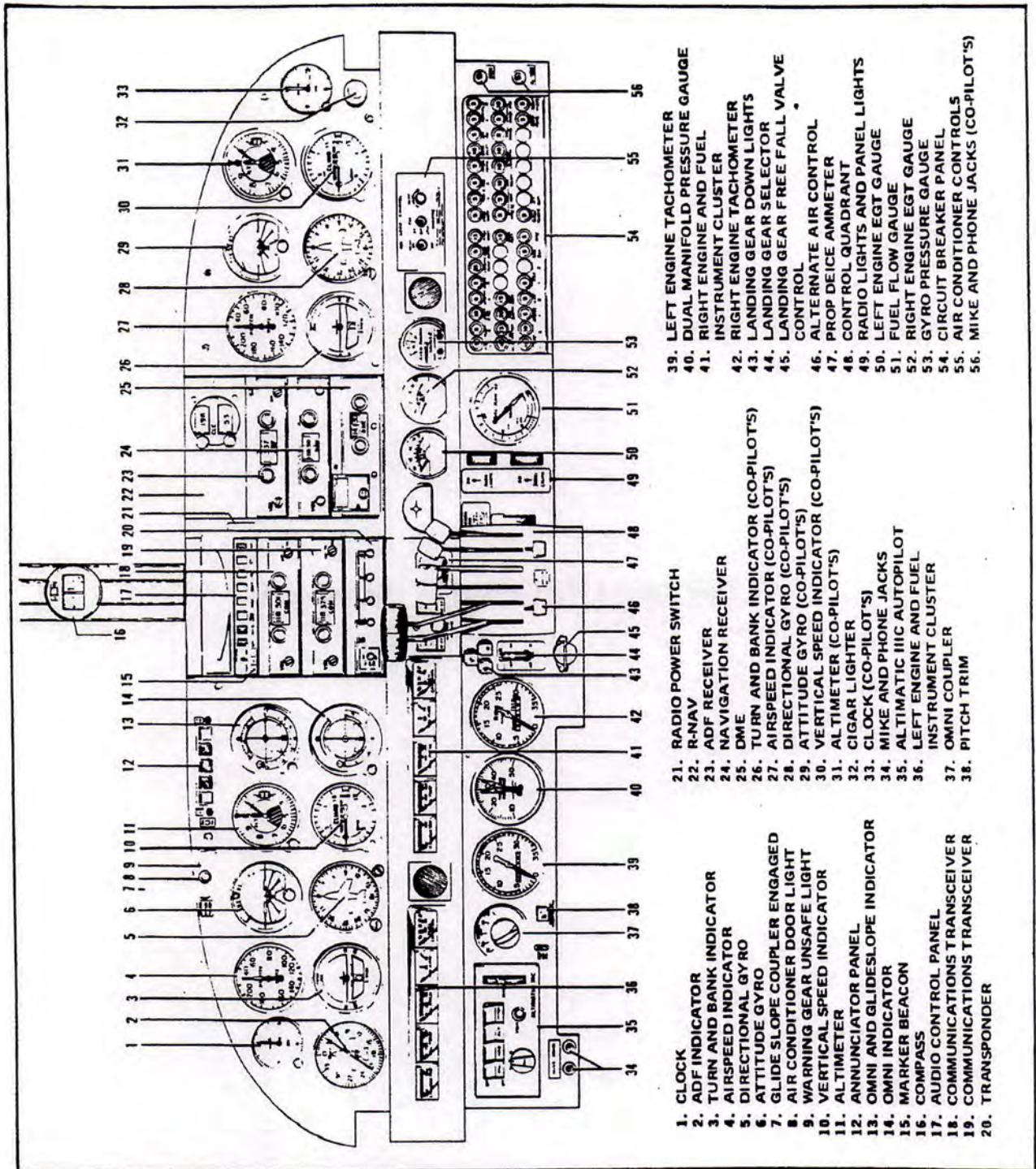

INSTRUMENT PANEL (SERIAL NUMBERS 34-7970001 AND UP)

Figure 7-21a

**THIS PAGE INTENTIONALLY LEFT BLANK**

### 7.23 INSTRUMENT PANEL

Flight instruments are grouped in the upper instrument panel (Figure 7-21); engine and electrical system monitoring instruments, the autopilot, and the circuit breaker panel are in the lower instrument panel. Left and right engine instruments are separated by the left control wheel shaft.

Radios are mounted in the center of the upper instrument panel. The control quadrant - throttles and propeller and mixture controls - is in the center of the lower instrument panel. To the left of the control quadrant is the landing gear selector.

Various warning lights are located with the pilot's flight instruments on the left upper instrument panel. The gear unsafe warning light is to the left of the annunciator panel.

The annunciator panel, with manifold pressure overboost, oil pressure, gyro pressure and alternator lights, and incorporating a press-to-test feature, is located to the upper left of the radios. The illumination of these lights in flight is an indication of a possible system malfunction. The pilot should closely monitor instrument panel gauges to check the condition of a system whose corresponding light on the annunciator panel illuminates. Illumination of the manifold pressure overboost lights indicates manifold pressure at or above the maximum allowable 40 inches Hg. During preflight, the operational status of the annunciator panel, except auxiliary fuel pump lights, should be tested by use of the press-to-test button. When the button is depressed, all annunciator panel lights, except auxiliary fuel pump lights, should illuminate.

#### NOTE

When an engine is feathered, the alternator, gyro air and engine oil pressure annunciator lights will remain illuminated.

Instrument panel lighting can be dimmed or brightened by rheostat switches to the right of the control quadrant. Back-lights are standard equipment, and map lights, and reading lights are available as options. When instrument panel lights are turned on, annunciator lights are dimmed. However, they will not show dim when the press-to-test switch is depressed.

Most of the electrical switches are located on the switch panel on the left side of the cockpit. A radio power switch is located near the top of the instrument panel between the radio stacks. It controls the power to all radios through the aircraft MASTER switch. The radio power switch has an OFF, NORMAL and AUXILIARY position. The AUXILIARY position provides a secondary power circuit for all radios.

On later models equipped with the two position switch (NORMAL AND OFF), an emergency bus switch is also provided to provide auxiliary power to the avionics bus in event of a radio master switch circuit failure. The emergency bus switch is located behind the lower right shin guard left of the circuit breaker panel.

The manifold pressure lines have drain valves located behind and below the dual manifold pressure gauge. This allows any moisture which may have collected from condensation to be pulled into the engines. This is accomplished by depressing the two valves for 5 seconds while operating the engines at 1000 RPM.

#### NOTE

Do not depress the valves when manifold pressure exceeds 25 inches Hg.

**THIS PAGE INTENTIONALLY LEFT BLANK**

## 7.25 HEATING, VENTILATING AND DEFROSTING SYSTEM

Heated air for cabin heat and windshield defrosting is provided by a Janitrol combustion heater located in the aft fuselage behind the cabin baggage compartment close-off (refer to Figure 7-23). Air from the heater is ducted forward along the cabin floor to outlets at each seat and to the windshield area.

Operation of the combustion heater is controlled by a three-position switch located on the control console (Figure 7-25) between the front seats and labeled FAN, OFF and HEATER. Airflow and temperature are regulated by the two levers on the console. The right-hand lever regulates air intake and the left-hand lever regulates cabin temperature. Cabin comfort can be maintained as desired through various combinations of lever positions. Passengers have secondary control over heat output by individually adjustable outlets at each seat location.

For cabin heat, the air intake lever on the heater control console must be partially or fully open and the three-position switch set to the HEATER position. This simultaneously starts fuel flow and ignites the heater; and, during ground operation, it also activates the ventilation blower which is an integral part of the combustion heater. With instant starting and no need for priming, heat should be felt within a few seconds. When cabin air reaches the temperature selected on the cabin temperature lever, ignition of the heater cycles automatically to maintain the selected temperature. Two safety switches activated by the intake valve and located aft of the heater unit prevent both fan and heater operation when the air intake lever is in the closed position. A micro switch, which actuates when the landing gear is retracted, turns off the ventilation blower so that in flight the cabin air is circulated by ram air pressure only.

When the three-position switch is in the FAN position during ground operation, the ventilation fan blows fresh air through the heater ductwork for cabin ventilation and windshield defogging when heat is not desired. When the heater controls are used either for cabin heat or for ventilation, air is automatically ducted to the windshield area for defrosting.

The flow of defroster air to the windshield area can be increased by the activation of a defroster fan. The fan is controlled by a defroster switch located on the control console between the two front seats.

To introduce fresh, unheated air into the cabin during flight, the air intake should be open and the heater off. Ram air enters the system and can be individually regulated at each floor outlet. Overhead outlets also supply fresh air for cabin ventilation. The occupant of each seat can manually adjust an outlet in the ceiling to regulate the flow of fresh air to that seat area. An optional fresh air blower may be installed in the overhead ventilation system to provide additional fresh air flow during ground operation.

An overheat switch located in the heater unit acts as a safety device to render the heater inoperative if a malfunction should occur. Should the switch deactivate the heater, the OVERHEAT light on the control console will illuminate. The overheat switch is located on the forward outboard end of the heater vent jacket. The red reset button on the heater shroud can be reached through the bulkhead access panel in the aft cabin close-out panel.

To prevent activation of the overheat switch upon normal heater shutdown during ground operation, turn the three-position switch to FAN for two minutes with the air intake lever in the open position before turning the switch to OFF. During flight, leave the air intake lever open for a minimum of fifteen seconds after turning the switch to OFF.

The combustion heater uses fuel from the airplane fuel system. An electric fuel pump draws fuel from the left tank at a rate of approximately one-half gallon per hour. Fuel used for heater operation should be considered when planning for a flight.

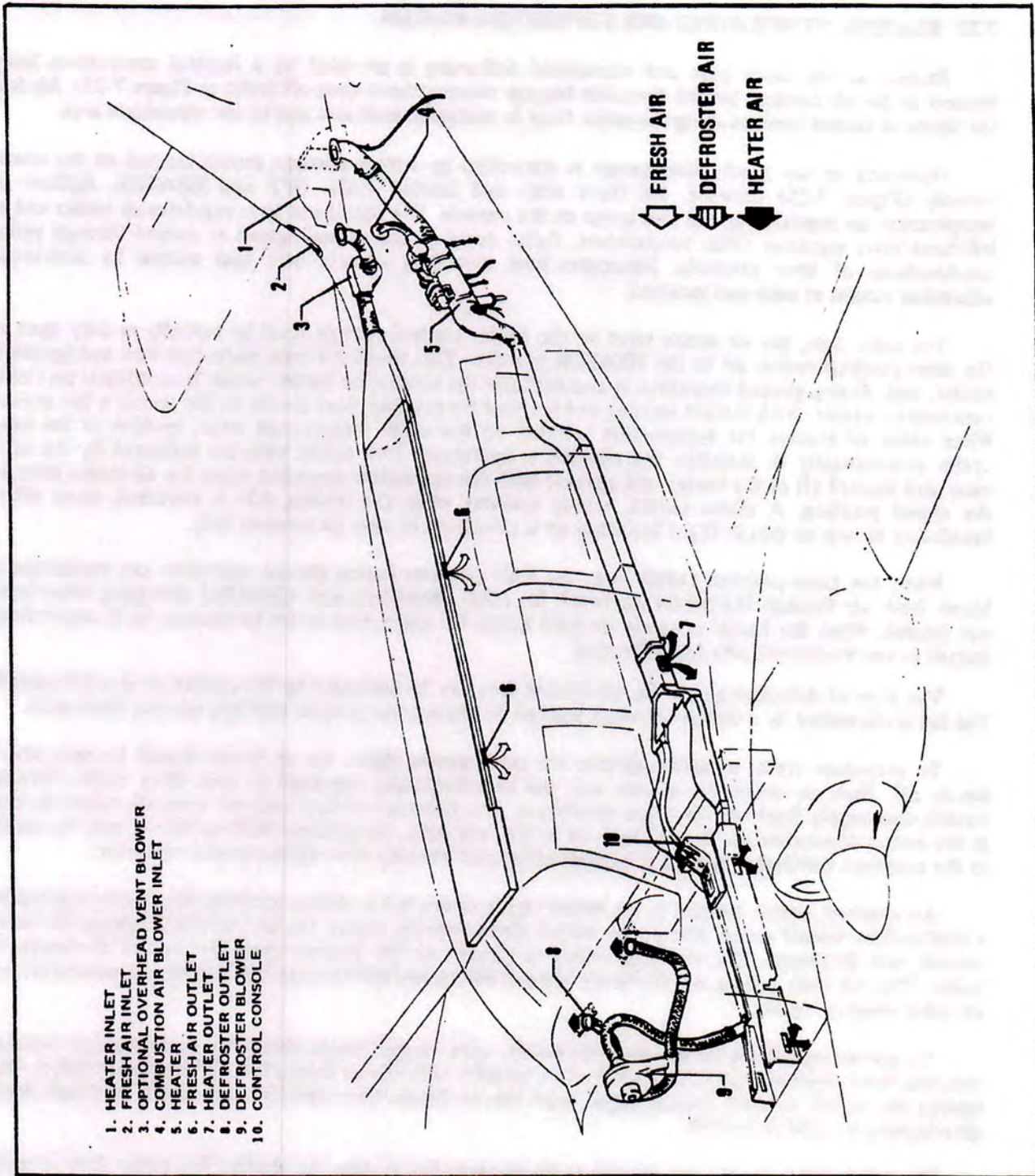

CABIN HEATING, VENTILATING AND DEFROSTING SYSTEM

Figure 7-23



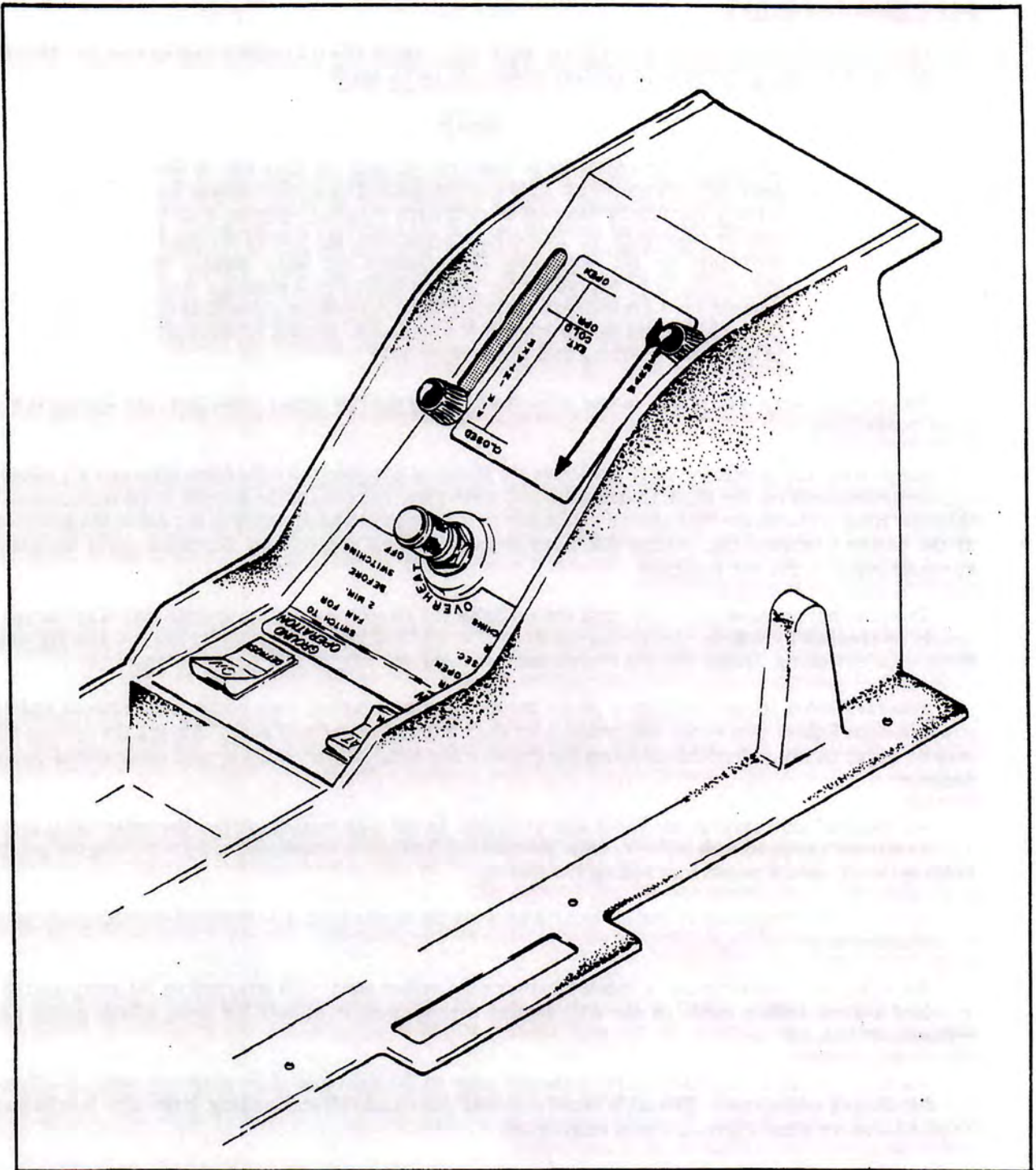

HEATING, VENTILATING AND DEFROSTING CONTROL CONSOLE

Figure 7-25

## **7.27 CABIN FEATURES**

The front seats are adjustable fore and aft. Each seat reclines and is provided with an armrest. The center and rear seats are easily removed to provide additional cargo space.

### **NOTE**

To remove the center seats, retainers securing the back legs of the seats must be unlocked. This is accomplished on earlier models by turning the slotted head aft of each back leg ninety degrees with a coin or a screwdriver. In the locked position, the slot on the head runs fore to aft. Releasing the retainers on later models is accomplished by depressing the plunger behind each front leg. Any time the seats are installed in the airplane, the retainers should be in the locked position. To remove the rear seats, depress the plunger behind each front leg and slide seat to rear.

An optional jump seat, which can be mounted between the two center seats, gives the Seneca II seven-place capabilities.

Single strap adjustable shoulder harnesses are standard equipment for the front seats and are offered as optional equipment for the third, fourth, fifth and sixth seats, but not for the seventh or aft facing seats. The shoulder strap is routed over the shoulder adjacent to the windows and attached to the belt in the general area of the person's inboard hip. Adjust this fixed strap so that all controls are accessible while maintaining adequate restraint for the occupant.

Shoulder harnesses with inertial reels are available for all seats except the seventh seat. The inertial reel should be checked by tugging sharply on the strap. The reel will lock in place under this test and prevent the strap from extending. Under normal movement, the strap will extend and retract as required.

Standard cabin features include a pilot's storm window, ashtrays, map pockets, coat hooks and assist straps, a cigar lighter, sun visors, and pockets on the front and center seat backs. Among the options which may be added to suit individual needs are headrests, a fire extinguisher, and a special cabin sound-proofing package.

An optional club seating interior is also available. In the club seating interior the center seats face aft. These seats are equipped with lap belts only. Removal of the seats is accomplished by removing the two bolts holding the aft attach points and sliding the seat aft.

An optional refreshment console is located between the center seats. It is removed in an identical manner to the center seats.

An optional oxygen system is located between the center seats. It is strapped to the jump seat in the standard seating arrangement. In the club seating arrangement it utilizes the same attach points as the refreshment console.

An optional cabin work table, serving the two seats on the right side of the passenger cabin, is offered to the club seating arrangement. The table must be stowed during takeoff and landing. If the table is to be used, it should be set up after a level cruise is established.

To remove the cabin work table from the aft baggage compartment, unlock the stud located on the bottom of the close-out bulkhead. Loosen the white tie-down strap and remove the table from the mounting brackets by lifting the table two inches straight up until it clears the mounting brackets. Do not twist the table while it is in the brackets.

To install the cabin work table during flight, hold the table in place and tilt the free end of the table upward 30° until the lobed upper knobs on the table supports align with the top holes of the escutcheons located below the right cabin window trim. Hold the upper lobes in place and lower the free end of the table to the level work position. The retaining springs will click when secure.

To stow the cabin work table, remove the table by lifting the free end of the table upward to disengage the bottom lobes of the table supports. Lift until the top support lobes disengage at approximately 30° of tilt and remove the table. Position the table in the stowage area and, with the table work surface facing forward, place the slots in the table support into the receptacle clips mounted on the hat shelf. Make sure the white tie-down strap is not behind the table. With the table fully placed in the clips, bring the white tie-down strap across the face of the table and lock over the stud located on the bottom of the close-out bulkhead.

### **7.29 STALL WARNING**

An approaching stall is indicated by a stall warning indicator which is activated between five and ten knots above stall speed. Mild airframe buffeting and gentle pitching may also precede the stall. Stall speeds are shown on a graph in the Performance Charts Section. The stall warning indicator consists of a continuous sounding horn located behind the instrument panel. The stall warning horn has a different sound from that of the gear warning horn which also has a 90 cycles per minute beeping sound. The stall warning indicator is activated by two lift detectors on the leading edge of the left wing, outboard of the engine nacelle. The inboard detector activates the indicator when the flaps are in the 25 and 40 degree positions, the outboard when the flaps are in other positions.

### **7.31 BAGGAGE AREA**

There are two separate baggage compartments. One, the nose section baggage compartment, is accessible through a baggage door on the left side of the nose section. It has a maximum weight capacity of 100 pounds. The cabin baggage compartment, located aft of seats five and six has a weight capacity of 100 pounds. This compartment is loaded and unloaded through the rear cabin door, and it is accessible during flight. Tie-down straps are provided and they should be used at all times. A cargo loading door, installed aft of the rear door, facilitates the loading of bulky items. All cargo, baggage compartment and passenger doors use the same key. The nose section baggage compartment door key can be removed only when in the locked position.

A nose section baggage compartment light illuminates automatically whenever the baggage door is opened. The baggage compartment light is independent of the aircraft master switch; therefore, when the baggage door is opened, the light will illuminate regardless of the position of the master switch. When the baggage compartment light option is installed, the baggage door should not be left open or ajar for extended time periods as battery depletion could result.

#### **NOTE**

It is the pilot's responsibility to be sure when baggage is loaded that the airplane C.G. falls within the allowable C.G. range. (See Weight and Balance Section.)

### **7.33 FINISH**

All exterior surfaces are finished with acrylic lacquer. To keep the finish attractive, economy size spray cans of touch-up paint are available from Piper Dealers. An optional polyurethane finish is available.

### **7.35 EMERGENCY LOCATOR TRANSMITTER\***

The Emergency Locator Transmitter (ELT) when installed, is located in the aft portion of the fuselage just below the stabilator leading edge and is accessible through a plate on the right side of the fuselage. This plate is attached with slotted-head nylon screws for ease of removal; these screws may be readily removed with a variety of common items such as a dime, a key, a knife blade, etc. If there are no tools available in an emergency the screw heads may be broken off by any means. The ELT is an emergency locator transmitter which meets the requirements of FAR 91.52.

A battery replacement date is marked on the transmitter to comply with FAA regulations, the battery must be replaced on or before this date. The battery must also be replaced if the transmitter has been used in an emergency situation or if the accumulated test time exceeds one hour, or if the unit has been inadvertently activated for an undetermined time period.

#### **NOTE**

If for any reason a test transmission is necessary, the test transmission should be conducted only in the first five minutes of any hour and limited to three audio sweeps. If the tests must be made at any other time, the tests should be coordinated with the nearest FAA tower or flight service station.

#### **NARCO ELT 10 OPERATION**

On the ELT unit itself is a three position switch placarded "ON," "OFF" and "ARM." The ARM position sets the ELT so that it will transmit after impact and will continue to transmit until its battery is drained. The ARM position is selected when the ELT is installed in the airplane and it should remain in that position.

To use the ELT as a portable unit in an emergency, remove the cover and unlatch the unit from its mounting base. The antenna cable is disconnected by a left quarter-turn of the knurled nut and a pull. A sharp tug on the two small wires will break them loose. Deploy the self-contained antenna by pulling the plastic tab marked "PULL FULLY TO EXTEND ANTENNA." Move the switch to ON to activate the transmitter.

In the event the transmitter is activated by an impact, it can only be turned off by moving the switch on the ELT unit to OFF. Normal operation can then be restored by pressing the small clear plastic reset button located on the top of the front face of the ELT and then moving the switch to ARM.

A pilot's remote switch located on the left side panel is provided to allow the transmitter to be turned on from inside the cabin. The pilot's remote switch is placarded "ON" and "ARMED." The switch is normally in the ARMED position. Moving the switch to ON will activate the transmitter. Moving the switch back to the ARMED position will turn off the transmitter only if the impact switch has not been activated.

The ELT should be checked to make certain the unit has not been activated during the ground check. Check by selecting 121.50 MHz on an operating receiver. If there is an oscillating chirping sound, the ELT may have been activated and should be turned off immediately. This requires removal of the access cover and moving the switch to OFF, then press the reset button and return the switch to ARM. Recheck with the receiver to ascertain the transmitter is silent.

\*Optional Equipment

### **CCC CIR 11-2 OPERATION**

On the unit itself is a three position selector switch placarded "OFF," "ARM" and "ON." The ARM position is provided to set the unit to the automatic position so that it will transmit only after impact and will continue to transmit until the battery is drained to depletion or until the switch is manually moved to the OFF position. The ARM position is selected when the transmitter is installed at the factory and the switch should remain in that position whenever the unit is installed in the airplane. The ON position is provided so the unit can be used as a portable transmitter or in the event the automatic feature was not triggered by impact or to periodically test the function of the transmitter.

Select the OFF position when changing the battery, when rearming the unit if it has been activated for any reason, or to discontinue transmission.

#### **NOTE**

If the switch has been placed in the ON position for any reason, the OFF position has to be selected before selecting ARM. If ARM is selected directly from the ON position, the unit will continue to transmit in the ARM position.

A pilot's remote switch, located on the left side panel, is provided to allow the transmitter to be controlled from inside the cabin. The pilot's remote switch is placarded "ON," "AUTO ARM" and "OFF RESET." The switch is normally left in the AUTO ARM position. To turn the transmitter off, move the switch momentarily to the OFF RESET position. The aircraft master switch must be ON to turn the transmitter OFF. To actuate the transmitter for tests or other reasons, move the switch upward to the ON position and leave it in that position as long as transmission is desired.

The unit is equipped with a portable antenna to allow the locator to be removed from the aircraft in case of an emergency and used as a portable signal transmitter.

The locator should be checked during the ground check to make certain the unit has not been accidentally activated. Check by tuning a radio receiver to 121.50 MHz. If there is an oscillating sound, the locator may have been activated and should be turned off immediately. Reset to the ARM position and check again to insure against outside interference.

THIS PAGE INTENTIONALLY LEFT BLANK

### **7.37 PIPER EXTERNAL POWER\***

An optional starting installation known as Piper External Power (PEP) allows the airplane engine to be started from an external battery without the necessity of gaining access to the airplane battery. The cable from the external battery can be attached to a receptacle under the left side of the nose section of the fuselage. Instructions on a placard located on the cover of the receptacle should be followed when starting with external power. For instructions on the use of the PEP, refer to Starting Engines - Section 4.

### **7.39 ICE PROTECTION SYSTEM\***

For flight into known icing conditions, a complete ice protection system (Figure 7-27) is available as optional equipment on the Seneca II.

The ice protection system consists of the following components: pneumatic wing and empennage boots, wing ice detection light, electrothermal propeller deice pads, electric windshield panel, heated lift detectors, and heated pitot head.

The pneumatic wing and empennage boots are installed on the leading edges of the wings, the vertical stabilizer and the horizontal stabilator. During normal operation, when the surface deicer system is turned off, the engine-driven pressure pumps apply a constant suction to the deicer boots to provide smooth, streamlined leading edges.

Deicer boots are inflated by a momentary "ON"-type "SURFACE DE-ICE" switch (Figure 7-29) located on the instrument panel directly above the control quadrant. Actuation of the surface deice switch activates a system cycle timer which energizes the pneumatic pressure control valves for six seconds. The boot solenoid valves are activated and air pressure is released to the boots, inflating all surface deicers on the airplane. A "Wing-Tail Deicer" indicator light, with a press-to-test feature, illuminates when the surface deicer boots inflate. When the cycle is complete, the deicer solenoid valves permit automatic overboard exhaustion of pressurized air. Suction is then reapplied to the deicer boots. The deicer boots do not inflate during the press-to-test cycle.

Circuit protection for the surface deicer system is provided by a "Wing-Tail De-icers" circuit breaker located on the circuit breaker panel.

Wing icing conditions may be detected during night flight by use of an ice detection light installed in the outboard side of the left engine nacelle. The light is controlled by an "ICE LIGHT" switch (Figure 7-29) located on the instrument panel to the right of the surface deice switch. A "Wing Ice Light" circuit breaker located in the circuit breaker panel provides circuit protection.

Electrothermal propeller deicer pads are bonded to the leading edges of the propeller blades. Each deicer pad has two separate heaters, one for the outboard and one for the inboard half. The system is controlled by an "On-Off"-type "PROP DE-ICE" switch (Figure 7-29) located to the right of the surface deice switch. Power for the propeller deicers is supplied by the airplane's electrical system through a "Prop De-ice" circuit breaker in the circuit breaker panel. When the prop deice switch is actuated, power is applied to a timer through the "Prop De-icer" ammeter which monitors the current through the propeller deicing system. With the propeller deicing system on, the prop deicer ammeter needle should indicate within the shaded portion of the ammeter for a normal reading.

\*Optional Equipment

**ISSUED: AUGUST 23, 1976  
REVISED: JUNE 30, 1983**

**REPORT: VB-850  
7-31**

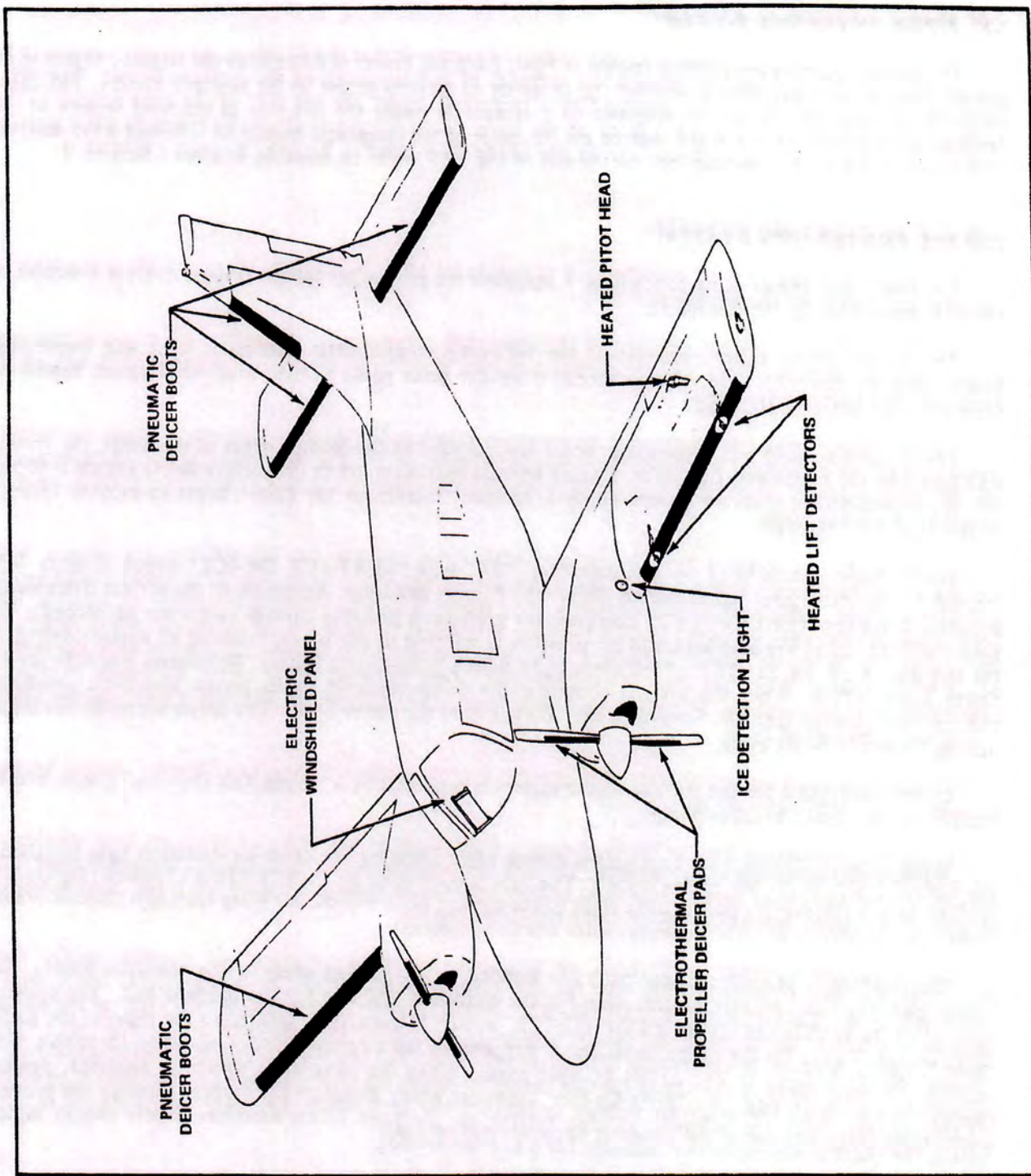

ICE PROTECTION SYSTEM

Figure 7-27



Power from the timer is cycled to brush assemblies which distribute power to slip rings. The current is then supplied from the slip rings directly to the electrothermal propeller deicer pads.

The Hartzell propellers are deiced by heating the outboard half and then the inboard half of the deicer pads in a timer controlled sequence. The heating sequence of the deicer pads is conducted in the following order:

- (a) Outboard halves of the propeller deicer pads on the right engine.
- (b) Inboard halves of the propeller deicer pads on the right engine.
- (c) Outboard halves of the propeller deicer pads on the left engine.
- (d) Inboard halves of the propeller deicer pads on the left engine.

\* The optional McCauley propellers are deiced by heating the entire deicer pads alternately in the following sequence.

- (a) The entire deicer pads on the right engine for 90 seconds.
- (b) The entire deicer pads on the left engine for 90 seconds.

When the system is turned on, heating may begin on any one of the above steps, depending upon the positioning of the timer switch when the system was turned off from previous use. Once begun, cycling will proceed in the above sequence and will continue until the system is turned off.

A preflight check of the propeller deicers can be performed by turning the prop deice switch on and feeling the propeller deicer pads for proper heating sequence. The deicer pads should become warm to the touch.

The heat provided by the deicer pads reduces the adhesion between the ice and the propeller so that centrifugal force and the blast of airstream cause the ice to be thrown off the propeller blades in very small pieces.

A heated glass panel is installed on the exterior of the pilot's windshield to provide visibility in icing conditions. The panel is heated by current from the airplane's electrical power supply and controlled by an "ON-OFF" control switch, circuit breaker. The control switch/circuit breaker is located in the right hand side of the de-ice panel and placarded "WINDSHIELD PANEL HEAT - SEE PILOT'S OPERATING HANDBOOK."

An operational check may be performed by turning the heated windshield panel switch on for a period not exceeding 30 seconds. Proper operation is indicated by the glass section being warm to the touch.

#### CAUTION

If the airplane is to be flown with the heated glass panel removed, rotate the receptacle plate 180° and replace it to cover the holes in the fuselage skin. Also replace the windshield collar screws.

Two heated lift detectors and a heated pitot head installed on the left wing are controlled by a single "On-Off"-type "HEATED PITOT" switch located on the switch panel to the left of the pilot.

The heated lift detectors, one inboard and one outboard on the left wing, are installed to prevent icing conditions from interfering with operation of the stall warning transmitters. A "Stall Warn Heat" circuit breaker in the circuit breaker panel protects the system against an overvoltage condition. The stall warning system should not be depended on when there is ice on the wing.

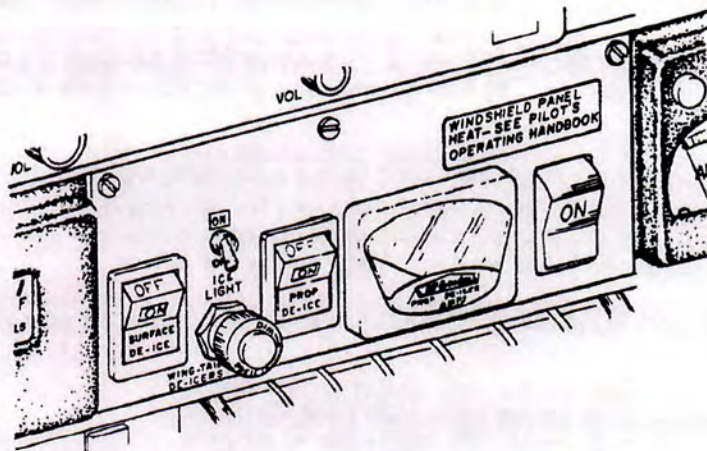

ICE DETECTION LIGHT, SURFACE DEICER, PROPELLER DEICER AND HEATED WINDSHIELD CONTROL SWITCHES

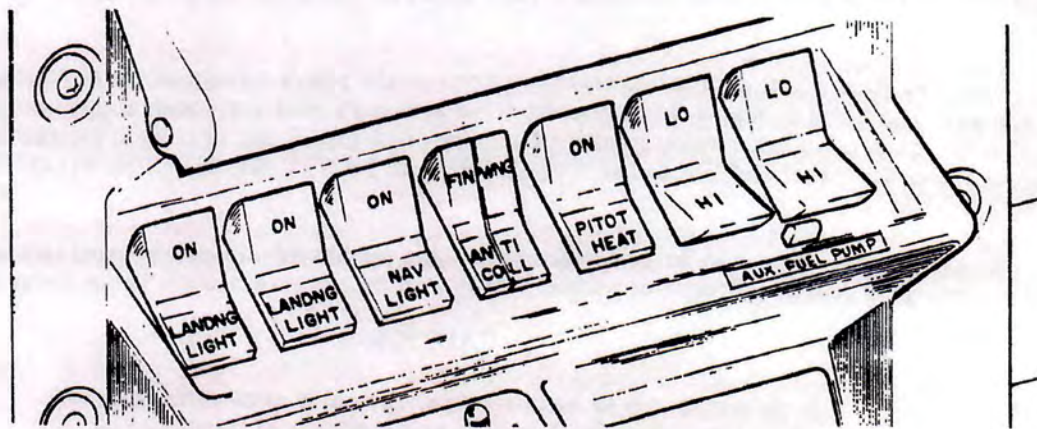

HEATED PITOT AND HEATED STALL WARNING TRANSMITTER CONTROL SWITCHES

ICE PROTECTION SYSTEM CONTROL SWITCHES

Figure 7-29

A heated pitot head, mounted under the left wing, is installed to provide pitot pressure for the airspeed indicator with heat to alleviate ice accumulation from blocking the pressure intake. The heated pitot head also has a separate circuit breaker located in the circuit breaker panel and labeled "Pitot Heat."

With the heated pitot switch on, check the heated pitot head and heated lift detector for proper heating.

#### CAUTION

Care should be taken when an operational check of the heated pitot head and the heated lift detectors is being performed. Both units become very hot. Ground operation should be limited to 3 minutes maximum to avoid damaging the heating elements.

#### 7.41 RADAR\*

A weather radar system can be installed in this airplane. The basic components of this installation are an antenna, a transmitter/receiver, and a cockpit indicator. The function of the weather radar system is to detect weather conditions along the flight path and to visually display a continuous weather outline on the cockpit indicator. Through interpretation of the advance warning given on the display, the pilot can make an early decision on the most desirable weather avoidance course.

In addition to its primary purpose, weather mapping, the system can be used for navigation. A ground mapping feature allows the pilot to identify coastlines, water masses, islands, high ground, etc. This provides the pilot with a guidance feature which may be useful in adverse weather conditions or over areas where ground-based navigational aids are limited.

For detailed information on the weather radar system and for procedures to follow in operating and adjusting the system to its optimum efficiency, refer to the appropriate operating and service manuals provided by the radar system manufacturer.

#### WARNING

Heating and radiation effects of radar can cause serious damage to the eyes and tender organs of the body. Personnel should not be allowed within fifteen feet of the area being scanned by the antenna while the system is transmitting. Do not operate the radar during refueling or in the vicinity of trucks or containers accomodating explosives or flammables. Flashbulbs can be exploded by radar energy. Before operating the radar in any mode other than STANDBY, direct the nose of the airplane so that the forward 120 degree sector is free of any metal objects such as other aircraft or hangars for a distance of at least 100 yards, and tilt the antenna upward 15 degrees. Do not operate the radar while the airplane is in a hangar or other enclosure.

\*Optional equipment

ISSUED: AUGUST 23, 1976  
REVISED: AUGUST 1, 1977

REPORT: VB-850  
7-35

NOTE

When operating weather avoidance radar systems inside of moderate to heavy precipitation, it is advisable to set the range scale of the radar to its lowest scale.

7.43 AIR CONDITIONING

The air conditioning system is a recirculating air system. The major components include an evaporator, a condenser, a compressor, a blower, switches and temperature controls.

The evaporator is located behind the rear baggage compartment. This cools the air used for the air conditioning system.

The condenser is mounted aft of the firewall on the left engine. A retractable condenser scoop extends when the air conditioner is on and retracts to a flush position when the air conditioner is off.

If the air conditioner is operated on the ground, the condenser scoop operates to a ground opening position which is larger than the in-flight opening. A circuit through the squat switch on the right main gear prevents the scoop operating to the ground opening when the aircraft is in flight.

The compressor is mounted on the rear left side of the left engine. It has an electric clutch which automatically engages or disengages the compressor to the belt drive system of the compressor.

Air from the baggage area is drawn through the evaporator by the blower and distributed through an overhead duct to individual outlets located adjacent to each occupant.

The switches and temperature control are located on the lower right side of the instrument panel. The temperature control regulates the temperature of the cabin. Turning the control clockwise increases cooling; counterclockwise decreases cooling.

The fan speed switch and the air conditioning ON-OFF switch are inboard of the temperature control. The fan can be operated independently of the air conditioning; however, the fan must be on for air conditioner operation. Turning either switch off will disengage the compressor clutch and retract the condenser door. Cooling air should be felt within one minute after the air conditioner is turned on.

NOTE

If the system is not operating in 5 minutes, turn the system OFF until the fault is corrected.

The fan switch allows operation of the fan with the air conditioner turned OFF to aid in cabin air circulation. "LOW" or "HIGH" can be selected to direct a flow of air through the air conditioner outlets in the overhead duct. These outlets can be adjusted or turned off individually.

The condenser door light is located to the left of the warning gear unsafe light in front of the pilot. The door light illuminates when the door is open and is off when the door is closed.

A circuit breaker on the circuit breaker panel protects the air conditioning electrical system.

#### 7.45 PORTABLE OXYGEN SYSTEM

A portable oxygen system to provide supplementary oxygen for the crew and passengers during high altitude flights (above 10,000 feet) is available as optional equipment. The system is secured to the middle center seat with the forward facing seating arrangement and mounted between the center seats with the club seating arrangement. (Refer to Section 9, Supplement 2, for FAA Approve supplemental information.)

The major components of the system consist of two console cylinder kits and six oxygen masks. Each console is equipped with a 22 cubic foot oxygen cylinder, an oxygen supply gauge, an ON-OFF flow control knob and two plug-in receptacles. Two single supply line masks and two dual supply line masks, which utilize dual manifold connectors, are provided to supply six masks with only four outlets.

Each cylinder is enclosed in a console carrying case with a separate supply gauge and ON-OFF flow control knob mounted on the sloped face of each unit. Two plug-in outlets are mounted below the gauge and control knob on each console. The masks for the rear seats are stowed in the pockets on the center seats and all other masks are stowed in the consoles.

When fully charged, each cylinder contains oxygen at a pressure of 1850 psi at 70° F. the filler port is enclosed by a cover at the rear of each unit. If high altitude flight is anticipated, it should be determined that the oxygen supply is adequate for the proposed flight and that the passengers are briefed. When oxygen is required, insert the mask plug-in connector into an outlet and lock by rotating the connector approximately 1/4 turn. Don mask (s) and rotate the ON-OFF control knob fully counterclockwise (approximately two full turns).

Each mask assembly oxygen line incorporates a flow indicator. When the red pellet in the indicator disappears, oxygen is flowing through the line normally. If the red indicator appears in any of the lines during a period when oxygen is essential, the airplane should be lowered to a safe altitude immediately.

Always remove fittings from the oxygen receptacles and stow the masks when they are not in use. Connect only those mask assemblies being used to prevent oxygen loss through and unused mask assembly. If the control knob is ON and the fitting is in the receptacle, oxygen will flow through the mask continuously. If a dual manifold connector is used, both masks must be donned. Masks may be damaged if they are not properly stowed.

#### WARNING

Positively no smoking while oxygen is being used by anyone in the airplane.

To stop the flow of oxygen through the system, the control knob should be turned OFF by rotating fully clockwise, finger tight.

To preclude the possibility of fire by spontaneous combustion, oil, grease, paint, hydraulic fluid and other flammable material should be kept away from oxygen equipment.

### **7.47 FIXED OXYGEN SYSTEM**

A fixed oxygen system to provide supplementary oxygen for the crew and passengers during high altitude flights (above 10,000 feet) is available as optional equipment. The major components of the Scott oxygen system are a 63 cubic foot oxygen cylinder, an oxygen supply gauge, an on-off flow control knob, a pressure regulator, six plug in receptacles and six oxygen masks.

The oxygen cylinder is mounted aft in the tail cone. When fully charged, the cylinder contains oxygen at a pressure of 1850 psi at 70° F. The oxygen supply gauge is mounted in the aft overhead vent duct. The oxygen flow control knob, labeled "Pull-On" is mounted in the pilot's overhead panel. The pressure regulator is mounted directly on the oxygen cylinder, once the oxygen flow control knob is on, each of the oxygen plug-in receptacles operates as an automatic on-off valve. The oxygen cylinder can be recharged through the access door aft of the rear window on the left side of the fuselage.

If high altitude flight is anticipated, it should be determined that the oxygen supply is adequate for the proposed flight and that the passengers are briefed. When oxygen is required, the control knob should be pulled forward to the ON position, allowing oxygen to flow from the cylinder through the system. Connecting the constant flow mask fitting to a receptacle and turning it 90 degrees clockwise, automatically releases oxygen to the mask through the on-off valve feature of the receptacle. The occupant then dons the mask and breathes normally for a sufficient supply of oxygen.

Each mask assembly oxygen line incorporates a flow indicator. When the red pellet in the indicator disappears, oxygen is flowing through the line normally. If the red indicator appears in any of the lines during a period when oxygen use is essential, the airplane should be lowered to a safe altitude immediately.

When not in use, mask may be stowed in the storage pockets behind the front and center seats. Always remove fittings from the oxygen receptacles and stow the mask when they are not in use. If the control knob is pulled on and the fitting is in the receptacle, oxygen will flow through the mask continuously. Masks may be damaged if they are not properly stowed.

#### **CAUTION**

**Positively NO SMOKING while oxygen is being used by anyone in the aircraft.**

To stop the flow of oxygen through the system, the control knob should be pushed aft to the OFF position. To bleed down low pressure lines, it is recommended that the mask assembly be left connected to the outlet for at least three minutes after the control knob is turned off.

To preclude the possibility of fire by spontaneous combustion, oil, grease, paint, hydraulic fluid, and other flammable material should be kept away from oxygen equipment.

**TABLE OF CONTENTS**

**SECTION 8**

**AIRPLANE HANDLING, SERVICING AND MAINTENANCE**

<b>Paragraph No.</b>		<b>Page No.</b>
8.1	General . . . . .	8-1
8.3	Airplane Inspection Periods . . . . .	8-3
8.5	Preventive Maintenance . . . . .	8-4
8.7	Airplane Alterations . . . . .	8-5
8.9	Ground Handling . . . . .	8-6
8.11	Engine Air Filter . . . . .	8-8
8.13	Brake Service . . . . .	8-8
8.15	Landing Gear Service . . . . .	8-9
8.17	Propeller Service . . . . .	8-9
8.19	Oil Requirements . . . . .	8-10
8.21	Fuel System . . . . .	8-10
8.23	Tire Inflation . . . . .	8-12
8.25	Battery Service . . . . .	8-12
8.27	Serial Number Plates . . . . .	8-13
8.29	Lubrication . . . . .	8-13
8.31	Cleaning . . . . .	8-13
8.33	Winterization . . . . .	8-15

3

3

3



## SECTION 8

### AIRPLANE HANDLING, SERVICING AND MAINTENANCE

#### 8.1 GENERAL

This section provides general guidelines relating to the handling, servicing and maintenance of the Seneca II.

Every owner should stay in close contact with his Piper dealer or distributor and Authorized Piper Service Center to obtain the latest information pertaining to his aircraft and to avail himself of the Piper Aircraft Service Back-up.

Piper Aircraft Corporation takes a continuing interest in having the owner get the most efficient use from his aircraft and keeping it in the best mechanical condition. Consequently, Piper Aircraft from time to time issues Service Bulletins, Service Letters and Service Spares Letters relating to the aircraft.

Service Bulletins are of special importance and should be complied with promptly. These are sent to the latest registered owners, distributors and dealers. Depending on the nature of the bulletin, material and labor allowances may apply, and will be addressed in the body of the Bulletin.

Service Letters deal with product improvements and service hints pertaining to the aircraft. They are sent to dealers, distributors and occasionally (at the factory's discretion) to latest registered owners, so they can properly service the aircraft and keep it up to date with the latest changes. Owners should give careful attention to the Service Letter information.

Service Spares Letters offer improved parts, kits and optional equipment which were not available originally and which may be of interest to the owner.

If an owner is not having his aircraft serviced by an Authorized Piper Service Center, he should periodically check with a Piper dealer or distributor to find out the latest information to keep his aircraft up to date.

Piper Aircraft Corporation has a Subscription Service for the Service Bulletins, Service Letters and Service Spares Letters. This service is offered to interested persons such as owners, pilots and mechanics at a nominal fee, and may be obtained through Piper dealers and distributors.

A service manual, parts catalog, and revisions to both, are available from Piper dealers or distributors. Any correspondence regarding the airplane should include the airplane model and serial number to insure proper response.

**THIS PAGE INTENTIONALLY LEFT BLANK**

### 8.3 AIRPLANE INSPECTION PERIODS

The Federal Aviation Administration (FAA) occasionally publishes Airworthiness Directives (ADs) that apply to specific groups of aircraft. They are mandatory changes and are to be complied with within a time limit set by the FAA. When an AD is issued, it is sent to the latest registered owner of the affected aircraft and also to subscribers of the service. The owner should periodically check with his Piper dealer or A & P mechanic to see whether he has the latest issued AD against his aircraft.

Piper Aircraft Corporation provides for the initial and first 50-hour inspection, at no charge to the owner. The Owner Service Agreement which the owner receives upon delivery of the aircraft should be kept in the aircraft at all times. This identifies him to authorized Piper dealers and entitles the owner to receive service in accordance with the regular service agreement terms. This agreement also entitles the transient owner full warranty by any Piper dealer in the world.

One hundred hour inspections are required by law if the aircraft is used commercially. Otherwise this inspection is left to the discretion of the owner. This inspection is a complete check of the aircraft and its systems, and should be accomplished by a Piper Authorized Service Center or by a qualified aircraft and power plant mechanic who owns or works for a reputable repair shop. The inspection is listed, in detail, in the inspection report of the appropriate Service Manual.

An annual inspection is required once a year to keep the Airworthiness Certificate in effect. It is the same as a 100-hour inspection except that it must be signed by an Inspection Authorized (IA) mechanic or a General Aviation District Office (GADO) representative. This inspection is required whether the aircraft is operated commercially or for pleasure.

A Progressive Maintenance program is approved by the FAA and is available to the owner. It involves routine and detailed inspections at 50-hour intervals. The purpose of the program is to allow maximum utilization of the aircraft, to reduce maintenance inspection cost and to maintain a maximum standard of continuous airworthiness. Complete details are available from Piper dealers.

A spectographic analysis of the oil is available from several sources. This system, if used intelligently, provides a good check of the internal condition of the engine. For this system to be accurate, oil samples must be sent in at regular intervals, and induction air filters must be cleaned or changed regularly.

### **8.5 PREVENTIVE MAINTENANCE**

The holder of a Pilot Certificate issued under FAR Part 61 may perform certain preventive maintenance described in FAR Part 43. This maintenance may be performed only on an aircraft which the pilot owns or operates and which is not used in air carrier service. The following is a list of the maintenance which the pilot may perform:

- (a) Repair or change tires and tubes.
- (b) Service landing gear wheel bearings, such as cleaning, greasing or replacing.
- (c) Service landing gear shock struts by adding air, oil or both.
- (d) Replace defective safety wire and cotter keys.
- (e) Lubrication not requiring disassembly other than removal of non-structural items such as cover plates, cowling or fairings.
- (f) Replenish hydraulic fluid in the hydraulic reservoirs.
- (g) Refinish the exterior or interior of the aircraft (excluding balanced control surfaces) when removal or disassembly of any primary structure or operating system is not required.
- (h) Replace side windows and safety belts.
- (i) Replace seats or seat parts with replacement parts approved for the aircraft.
- (j) Replace bulbs, reflectors and lenses of position and landing lights.
- (k) Replace cowling not requiring removal of the propeller.
- (l) Replace, clean or set spark plug clearance.
- (m) Replace any hose connection, except hydraulic connections, with approved replacement hoses.
- (n) Remove the battery and check fluid level and specific gravity.

Although the above work is allowed by law, each individual should make a self analysis as to whether he has the ability to perform the work.

If the above work is accomplished, an entry must be made in the appropriate logbook. The entry should contain:

- (a) The date the work was accomplished.
- (b) Description of the work.
- (c) Number of hours on the aircraft.
- (d) The certificate number of pilot performing the work.
- (e) Signature of the individual doing the work.

### 8.7 AIRPLANE ALTERATIONS

If the owner desires to have his aircraft modified, he must obtain FAA approval for the alteration. Major alterations accomplished in accordance with Advisory Circular 43.13-2, when performed by an A & P mechanic, may be approved by the local FAA office. Major alterations to the basic airframe or systems not covered by AC 43.13-2 require a Supplemental Type Certificate.

The owner or pilot is required to ascertain that the following Aircraft Papers are in order and in the aircraft.

- (a) To be displayed in the aircraft at all times:
  - (1) Aircraft Airworthiness Certificate Form FAA-8100-2.
  - (2) Aircraft Registration Certificate Form FAA-8050-3.
  - (3) Aircraft Radio Station License if transmitters are installed.
  
- (b) To be carried in the aircraft at all times:
  - (1) Pilot's Operating Handbook.
  - (2) Weight and Balance data plus a copy of the latest Repair and Alteration Form FAA-337, if applicable.
  - (3) Aircraft equipment list.

Although the aircraft and engine logbooks are not required to be in the aircraft, they should be made available upon request. Logbooks should be complete and up to date. Good records will reduce maintenance cost by giving the mechanic information about what has or has not been accomplished.

---

**8.9 GROUND HANDLING**

**(a) Towing**

The airplane may be moved on the ground by the use of the nose wheel steering bar that is stowed aft of the fifth and sixth seats or by power equipment that will not damage or excessively strain the nose gear steering assembly. Towing lugs are incorporated as part of the nose gear fork.

**CAUTION**

When towing with power equipment, do not turn the nose gear beyond its steering radius in either direction, as this will result in damage to the nose gear and steering mechanism.

**CAUTION**

Do not tow the airplane when the controls are secured.

In the event towing lines are necessary, ropes should be attached to both main gear struts as high up on the tubes as possible. Lines should be long enough to clear the nose and/or tail by not less than fifteen feet, and a qualified person should ride in the pilot's seat to maintain control by use of the brakes.

**(b) Taxiing**

Before attempting to taxi the airplane, ground personnel should be instructed and approved by a qualified person authorized by the owner. Engine starting and shut-down procedures as well as taxi techniques should be covered. When it is ascertained that the propeller back blast and taxi areas are clear, power should be applied to start the taxi roll, and the following checks should be performed:

- (1) Taxi a few feet forward and apply the brakes to determine their effectiveness.
- (2) Taxi with the propeller set in low pitch, high RPM setting.
- (3) While taxiing, make slight turns to ascertain the effectiveness of the steering.
- (4) Observe wing clearance when taxiing near buildings or other stationary objects. If possible, station an observer outside the airplane.
- (5) When taxiing over uneven ground, avoid holes and ruts.
- (6) Do not operate the engine at high RPM when running up or taxiing over ground containing loose stones, gravel, or any loose material that may cause damage to the propeller blades.

(c) Parking

When parking the airplane, be sure that it is sufficiently protected from adverse weather conditions and that it presents no danger to other aircraft. When parking the airplane for any length of time or overnight, it is suggested that it be moored securely.

- (1) To park the airplane, head it into the wind if possible.
- (2) Set the parking brake by pulling back on the brake lever and depressing the knob on the handle. To release the parking brake, pull back on the handle until the catch disengages; then allow the handle to swing forward.

CAUTION

Care should be taken when setting brakes that are overheated or during cold weather when accumulated moisture may freeze a brake.

- (3) Aileron and stabilator controls should be secured with the front seat belt and chocks used to properly block the wheels.

(d) Mooring

The airplane should be moored for immovability, security and protection. The following procedures should be used for the proper mooring of the airplane:

- (1) Head the airplane into the wind if possible.
- (2) Retract the flaps.
- (3) Immobilize the ailerons and stabilator by looping the seat belt through the control wheel and pulling it snug.
- (4) Block the wheels.
- (5) Secure tie-down ropes to the wing tie-down rings and to the tail skid at approximately 45 degree angles to the ground. When using rope of non-synthetic material, leave sufficient slack to avoid damage to the airplane should the ropes contract.

CAUTION

Use bowline knots, square knots or locked slip knots. Do not use plain slip knots.

NOTE

Additional preparations for high winds include using tie-down ropes from the landing gear forks and securing the rudder.

- (6) Install a pitot head cover if available. Be sure to remove the pitot head cover before flight.
- (7) Cabin and baggage doors should be locked when the airplane is unattended.

### **8.11 ENGINE INDUCTION AIR FILTERS**

**(a) Removing Induction Air Filter**

- (1) Remove the right hand section of the cowling to gain access to the air filter box.**
- (2) Turn the four studs and remove the air filter box cover.**
- (3) Lift the air filter from the filter box.**

**(b) Cleaning Induction Air Filters**

The induction air filters must be cleaned at least once every 50 hours, and more often, even daily, when operating in dusty conditions. Extra filters are inexpensive, and a spare should be kept on hand for use as a rapid replacement.

To clean the filter:

- (1) Tap filter gently to remove dirt particles. Do not use compressed air or cleaning solvents.**
- (2) Inspect filter. If paper element is torn or ruptured or gasket is damaged, the filter should be replaced. The usable life of the filter should be restricted to one year or 500 hours, whichever comes first.**

**(c) Installation of Induction Air Filters**

After cleaning, place filter in air box and install cover. Secure cover by turning studs. Replace cowl.

### **8.13 BRAKE SERVICE**

The brake system is filled with MIL-H-5606 (petroleum base) hydraulic brake fluid. This should be checked periodically or at every 50-hour inspection and replenished when necessary. The brake reservoir is located to the rear of the front baggage compartment. Remove the access panel marked "Brake Reservoir Behind" located at the top rear of the compartment. Keep the fluid level at the level marked on the reservoir.

No adjustment of brake clearance is necessary. Refer to the PA-34-200T Service Manual for brake lining replacement instructions.



8.15 LANDING GEAR SERVICE

Two jack points are provided for jacking the aircraft for servicing. One is located outboard of each main landing gear and one just aft of the nose gear. Before jacking, attach a tail support to the tail skid. Approximately 500 pounds of ballast should be placed on the tail support.

CAUTION

Be sure to apply sufficient support ballast; otherwise the airplane may tip forward, and the nose section could be damaged.

Landing gear oleos should be serviced according to instruction on the units. Under normal static load (empty weight of airplane plus full fuel and oil), main oleo struts should be exposed three and one half inches and the nose oleo strut should be exposed two and one half inches. Refer to PA-34-200T Service Manual for complete information on servicing oleo struts.

8.17 PROPELLER SERVICE

(a) Hartzell Propellers:

The gas charge in the propeller cylinder should be kept at the pressure specified on the placard located in the spinner cap. The pressure in the cylinder will increase about one-third psi for every degree Fahrenheit increase in temperature. This effect should be considered when checking pressure. The charge maintained must be accurate and free of excessive moisture since moisture may freeze the piston during cold weather. Dry nitrogen gas is recommended.

CHAMBER PRESSURE REQUIREMENTS WITH  
TEMPERATURE FOR HARTZELL COUNTERWEIGHT TYPE PROPELLERS

Temp. ° F	PRESSURE (psi)	
	FOR PROPELLER HUBS: BHC-C2YF-2CKF and BHC-C2YF-2CLKF	FOR PROPELLER HUBS: BHC-C2YF-2CKUF and BHC-C2YF-2CLKUF
70 to 100	62 ± 2	22 ± 2
40 to 70	57 ± 2	17 ± 2
0 to 40	54 ± 2	14 ± 2
-30 to 0	49 ± 2	9 ± 2

NOTE: Do not check pressure or charge with propeller in feather position.

(b) McCauley Propellers:

Since the McCauley propellers use oil pressure and compression spring force to achieve activation, there is no air/gas accumulator pressure to maintain. The propellers have been set at the factory and should not require any further servicing.

(c) Hartzell and McCauley Propellers:

The spinner and backing plate should be checked for the presence of oil, cleaned and inspected for cracks frequently. Before each flight the propeller should be inspected for nicks, scratches, or corrosion. If found, they should be repaired as soon as possible by a rated mechanic, since a nick or scratch causes an area of increased stress which can lead to serious cracks or the loss of a propeller tip. The back face of the blades should be painted when necessary with flat black paint to retard glare. To prevent corrosion, all surfaces should be cleaned and waxed periodically.

CAUTION

Do not operate three bladed McCauley propellers with the spinner bulkhead installed and the spinner dome removed. Damage can result to the spinner bulkhead cuff plates.

8.19 OIL REQUIREMENTS

The oil capacity of the Teledyne Continental engines is 8 quarts per engine with a minimum safe quantity of 3 quarts per engine. It is recommended that oil be added if the quantity falls to 6 quarts. It is recommended that engine oil be drained and renewed every 100 hours, or sooner under unfavorable conditions. Full flow cartridge type oil filters should be replaced each 50 hours of operation. The following grades are required for temperatures:

	Oil Viscosity per Average Ambient Temp.	S.A.E. No.
	Aviation Grade	
Below 40°F	1065	30
Above 40°F	1100	50

8.21 FUEL SYSTEM

(a) Servicing Fuel System

The fuel screens in the strainers require cleaning at 50 hour or 90 day intervals, whichever occurs first. The fuel gascolator strainers are located in the wing between the fuel selector valves and the auxiliary pumps in the nacelles. The fuel injector screen is located in the housing where the fuel inlet line connects to the injector. This screen should be cleaned every 50 hours of operation.

**(b) Fuel Requirements**

The minimum aviation grade fuel for the PA-34-200T is 100. Since the use of lower grades can cause serious engine damage in a short period of time, the engine warranty is invalidated by the use of lower octanes.

Whenever 100 or 100LL grade fuel is not available, commercial grade 100/130 should be used. (See Fuel Grade Comparison Chart.) Refer to the latest issue of Continental Service Bulletin "Fuel and Oil Grades" for additional information.

A summary of the current grades as well as the previous fuel designations is shown in the following chart:

**FUEL GRADE COMPARISON CHART**

Previous Commercial Fuel Grades (ASTM-D910)				Current Commercial Fuel Grades (ASTM-D910-75)			Current Military Fuel Grades (MIL-G-5572E) Amendment No. 3				
Grade	Color	Max. TEL ml U.S. gal.		Grade	Color	Max. TEL ml U.S. gal.		Grade	Color	Max. TEL ml U.S. gal.	
80 87	red	0.5		80	red	0.5		80 87	red	0.5	
91 98	blue	2.0		*100LL	blue	2.0		none	none	none	
100 130	green	3.0		100	green	**3.0		100 130	green	**3.0	
115 145	purple	4.6		none	none	none		115 145	purple	4.6	

- \* - Grade 100LL fuel in some overseas countries is currently colored green and designated as "100L."
- \*\* - Commercial fuel grade 100 and grade 100 130 (both of which are colored green) having TEL content of up to 4 ml U.S. gallon are approved for use in all engines certificated for use with grade 100 130 fuel.

The operation of the aircraft is approved with an anti-icing additive in the fuel. When an anti-icing additive is used it must meet the specification MIL-1-27686, must be uniformly blended with the fuel while refueling, must not exceed .15% by volume of the refueled quantity, and to ensure its effectiveness should be blended at not less than .10% by volume. One and one half liquid ozs. per ten gallon of fuel would fall within this range. A blender supplied by the additive manufacturer should be used. Except for the information contained in this section, the manufacturer's mixing or blending instructions should be carefully followed.

**CAUTIONS**

Assure that the additive is directed into the flowing fuel stream. The additive flow should start after and stop before the fuel flow. Do not permit the concentrated additive to come in contact with the aircraft painted surfaces or the interior surfaces of the fuel tanks.

Some fuels have anti-icing additives pre-blended in the fuel at the refinery, so no further blending should be performed.

Fuel additive can not be used as a substitute for preflight draining of the fuel system drains.

(c) **Filling Fuel Tanks**

Observe all required precautions for handling gasoline. Fill the fuel tanks to the bottom of the filler neck with 100/130 octane fuel. Each wing holds a maximum of 49 gallons, giving a total of 98 gallons of fuel. With optional fuel tanks installed, the total fuel capacity is increased to 128 gallons.

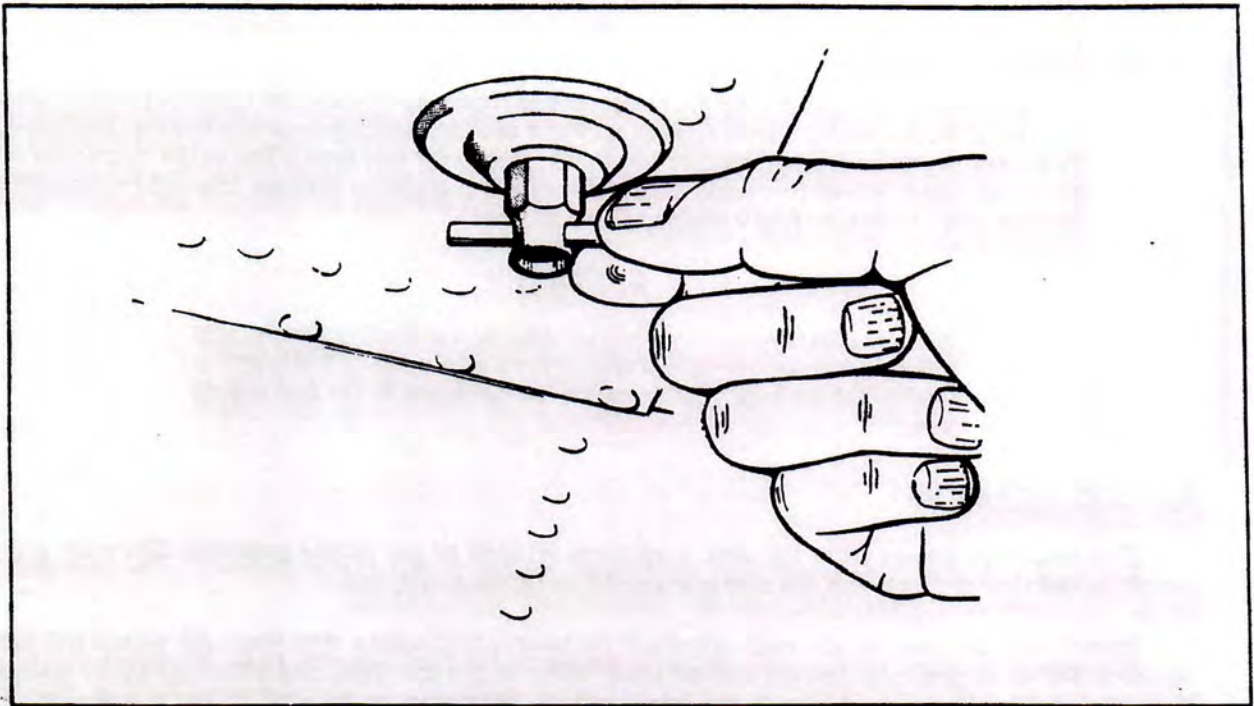

**FUEL DRAIN**

Figure 8-1

(d) **Draining Fuel Strainer, Sumps and Lines**

Each gascolator strainer is provided with a quick drain which should be drained before the first flight of the day and after refueling, to check for fuel contamination. If contamination is found, fuel should be drained until the contamination stops. If contamination persists after draining fuel for a minute, contact a mechanic to check the fuel system.

Each fuel tank is provided with a fuel quick drain to check for contamination. Each tank should be checked for contamination in accordance with the above procedure. Crossfeed drains are located on the bottom of the fuselage inboard of the right flap. The fuel drained at each quick drain should be collected in a transparent container and examined for contamination.

**CAUTION**

When draining any amount of fuel, care should be taken to ensure that no fire hazard exists before starting the engine.

After draining, each quick drain should be checked to make sure it has closed completely and is not leaking.

(e) Draining Fuel System

The bulk of the fuel may be drained from the system by opening the valve at the inboard end of each tank. Push up on the arms of the drain valve and turn counterclockwise to hold the drain open. Drain the fuel from the fuel strainer bowl and remove the fuel supply line at the carburetor servo. Run the electric driven fuel pump until the system is completely drained, this will require selecting all fuel tanks to ensure fuel is drained from all lines.

**CAUTION**

When the fuel system is completely drained and fuel is replenished it will be necessary to run the engine for a minimum of 3 minutes at 1000 RPM on each tank to ensure no air exists in the fuel supply lines.

**8.23 TIRE INFLATION**

For maximum service from the tires, keep them inflated to the proper pressures. The main gear tires should be inflated to 55 psi and the nose gear should be inflated to 31 psi.

Interchange the tires on the main wheels, if necessary, to produce even wear. All wheels and tires are balanced before original installation, and the relationship of the tire, tube, and wheel should be maintained if at all possible. Unbalanced wheels can cause extreme vibration on takeoff. In the installation of new components, it may be necessary to rebalance the wheel with the tire mounted.

When checking the pressure, examine the tires for wear, cuts, bruises, and slippage.

**8.25 BATTERY SERVICE**

Access to the 12-volt 35 ampere hour battery is gained through the nose baggage compartment. It is located under the floor panel of the nose baggage compartment. The battery container has a plastic drain tube which is normally closed off. This tube should be opened occasionally to drain off any accumulation of liquid.

The battery fluid level must not be brought above the baffle plates. It should be checked every 30 days to determine that the fluid level is proper and the connections are tight and free of corrosion. DO NOT fill the battery above the baffle plates. DO NOT fill the battery with acid - use distilled water only. A hydrometer check will determine the percent of charge in the battery.

If the battery is not properly charged, recharge it starting with a rate of 4 amperes and finishing with a rate of 2 amperes. Quick charges are not recommended.

The external power receptacle, if installed, is located on the left side of the nose section. Be sure that master switch is off while inserting or removing a plug at this receptacle.

Refer to the PA-34-200T Service Manual for detailed procedures for cleaning and servicing the battery.

### 8.27 SERIAL NUMBER PLATES

The serial number plate is located on the left side of the fuselage near the leading edge of the stabilator. The serial number should always be used when referring to the airplane on service or warranty matters.

### 8.29 LUBRICATION

Lubrication at regular intervals is an essential part of the maintenance of an airplane. For lubrication instructions and a chart showing lubrication points, types of lubricants to be used, lubrication methods and recommended frequencies, refer to the PA-34-200T Service Manual.

### 8.31 CLEANING

#### (a) Cleaning Engine Compartment

Before cleaning the engine compartment, place a strip of tape on the magneto vents to prevent any solvent from entering these units.

- (1) Place a large pan under the engine to catch waste.
- (2) With the engine cowling removed, spray or brush the engine with solvent or a mixture of solvent and degreaser. In order to remove especially heavy dirt and grease deposits, it may be necessary to brush areas that were sprayed.

#### CAUTION

Do not spray solvent into the alternator, pressure pump, starter, air intakes, or alternate air inlets.

- (3) Allow the solvent to remain on the engine from five to ten minutes. Then rinse the engine clean with additional solvent and allow it to dry.

#### CAUTION

Do not operate the engine until excess solvent has evaporated or otherwise been removed.

- (4) Remove the protective tape from the magnetos.
- (5) Lubricate the controls, bearing surfaces, etc., in accordance with the Lubrication Chart in the PA-34-200T Service Manual.

(b) Cleaning Landing Gear

Before cleaning the landing gear, place a plastic cover or similar material over the wheel and brake assembly.

- (1) Place a pan under the gear to catch waste.
- (2) Spray or brush the gear area with solvent or a mixture of solvent and degreaser, as desired. Where heavy grease and dirt deposits have collected, it may be necessary to brush areas that were sprayed, in order to clean them.
- (3) Allow the solvent to remain on the gear from five to ten minutes. Then rinse the gear with additional solvent and allow to dry.
- (4) Remove the cover from the wheel and remove the catch pan.
- (5) Lubricate the gear in accordance with the Lubrication Chart in the PA-34-200T Service Manual.
- (6) Caution: Do not brush the micro switches.

(c) Cleaning Exterior Surfaces

The airplane should be washed with a mild soap and water. Harsh abrasives or alkaline soaps or detergents could make scratches on painted or plastic surfaces or could cause corrosion of metal. Cover areas where cleaning solution could cause damage. To wash the airplane, use the following procedure:

- (1) Flush away loose dirt with water.
- (2) Apply cleaning solution with a soft cloth, a sponge or a soft bristle brush.
- (3) To remove exhaust stains, allow the solution to remain on the surface longer.
- (4) To remove stubborn oil and grease, use a cloth dampened with naphtha.
- (5) Rinse all surfaces thoroughly.
- (6) Any good automotive wax may be used to preserve painted surfaces. Soft cleaning cloths or a chamois should be used to prevent scratches when cleaning or polishing. A heavier coating of wax on the leading surfaces will reduce the abrasion problems in these areas.

(d) Cleaning Windshield and Windows

- (1) Remove dirt, mud and other loose particles from exterior surfaces with clean water.
- (2) Wash with mild soap and warm water or with aircraft plastic cleaner. Use a soft cloth or sponge in a straight back and forth motion. Do not rub harshly.
- (3) Remove oil and grease with a cloth moistened with kerosene.

CAUTION

Do not use gasoline, alcohol, benzene, carbon tetrachloride, thinner, acetone, or window cleaning sprays.

- (4) After cleaning plastic surfaces, apply a thin coat of hard polishing wax. Rub lightly with a soft cloth. Do not use a circular motion.
- (5) A severe scratch or mar in plastic can be removed by rubbing out the scratch with jeweler's rouge. Smooth both sides and apply wax.



(e) **Cleaning Headliner, Side Panels and Seats**

- (1) Clean headliner, side panels, and seats with a stiff bristle brush, and vacuum where necessary.
- (2) Soiled upholstery, except leather, may be cleaned with a good upholstery cleaner suitable for the material. Carefully follow the manufacturer's instructions. Avoid soaking or harsh rubbing.

**CAUTION**

Solvent cleaners require adequate ventilation.

- (3) Leather should be cleaned with saddle soap or a mild hand soap and water.

(f) **Cleaning Carpets**

To clean carpets, first remove loose dirt with a whisk broom or vacuum. For soiled spots and stubborn stains use a noninflammable dry cleaning fluid. Floor carpets may be removed and cleaned like any household carpet.

(g) **Cleaning Deicing Equipment\***

Clean the deicer boots when the airplane is washed, using a mild soap and water solution. Boots should be waxed or coated with one of several available boot care products for proper operation in icing conditions.

In cold weather, wash the boots while the airplane is in a warm hangar, if possible. If the cleaning is to be done outdoors, heat the soap and water solution before taking it to the airplane. If difficulty is encountered with water freezing on the boots, use a portable type ground heater to direct a blast of warm air along the area being cleaned.

Cleaning the boots with petroleum products such as benzol or nonleaded gasoline is not recommended, since such products are injurious to rubber. If such solvents are employed, they should be used sparingly and wiped off the surface with a clean dry cloth before the cleaner has time to soak into the rubber.

**8.33 WINTERIZATION**

For winter operation a winterization kit is installed on the inlet opening of the oil cooler outboard chamber of the plenum chamber. This kit should be installed whenever the ambient temperature is 50°F or less. When the kit is not being used it can be stowed in the nose cone compartment, left hand side, forward of the door, using the strap provided.

\*Optional equipment

THIS PAGE INTENTIONALLY LEFT BLANK

TABLE OF CONTENTS

SECTION 9

SUPPLEMENTS

Paragraph Supplement No.		Page No.
9.1	General .....	9-1
1	Windshield Heating Installation .....	9-3
2	Oxygen Installation .....	9-5
2A	Fixed Oxygen Installation .....	9-6a
3	AutoControl IIIB Autopilot Installation .....	9-7
4	AltiMatic IIIC Autopilot Installation .....	9-11
5	Air Conditioning Installation .....	9-19
6	KFC 200 AFCS (With FD Installation) .....	9-21
7	KFC 200 AFCS (Without FD Installation) .....	9-31
8	KNS 80 Navigation System .....	9-41
9	ANS 351 Area Navigation Computer .....	9-45
10	NP-2041A Area Navigation Computer Programmer .....	9-49
11	RDR-160 Weather Radar System .....	9-53
12	RDR-160 IN2026A Weather Radar System .....	9-57
13	Piper Control Wheel Clock Installation .....	9-61
14	RCA Weather Scout II Monochrome Weather Radar .....	9-63
15	RCA Weather Scout II Color Weather Radar .....	9-66
16	Garmin-GNC 430	1-7
17	SHADIN FCC File	

1880

1881

1882

1883

Year	...	...	...
1880	...	...	...
1881	...	...	...
1882	...	...	...
1883	...	...	...
1884	...	...	...
1885	...	...	...
1886	...	...	...
1887	...	...	...
1888	...	...	...
1889	...	...	...
1890	...	...	...

1891

1892

**SECTION 9**  
**SUPPLEMENTS**

**9.1 GENERAL**

This section provides information in the form of Supplements which are necessary for efficient operation of the airplane when equipped with one or more of the various optional systems and equipment not provided with the standard airplane.

All of the Supplements provided by this section are "FAA Approved" and consecutively numbered as a permanent part of this Handbook. The information contained in each Supplement applies only when the related equipment is installed in the airplane.

**THIS PAGE INTENTIONALLY LEFT BLANK**

## SUPPLEMENT 1

### WINDSHIELD HEATING INSTALLATION

#### SECTION 1 - GENERAL

This supplement supplies information necessary for the efficient operation of the airplane when the optional windshield heating system is installed. The information contained within this supplement is to be used in conjunction with the complete handbook.

This supplement has been "FAA Approved" as a permanent part of this handbook and must remain in this handbook at all times when the optional windshield heating system is installed.

#### SECTION 2 - LIMITATIONS

Under no circumstances should the unit be turned on for a period exceeding 30 seconds unless:

- (a) The aircraft is in flight or
- (b) Ice exists on the heated panel.

#### SECTION 3 - EMERGENCY PROCEDURES

No changes to the basic Emergency Procedures provided by Section 3 of this Pilot's Operating Handbook are necessary for this supplement.

#### SECTION 4 - NORMAL PROCEDURES

An operational check is accomplished by turning the heated panel switch on for a period not exceeding 30 SECONDS. Proper operation is indicated by the glass section being warm to the touch.

#### SECTION 5 - PERFORMANCE

An additional compass deviation card is required with this installation. This card should indicate corrected readings with windshield heat and radios on.

**THIS PAGE INTENTIONALLY LEFT BLANK**



SUPPLEMENT 2

OXYGEN INSTALLATION - SCOTT AVIATION PRODUCTS  
EXECUTIVE MARK III PART NUMBER 802180-00 OR 802180-01

SECTION 1 - GENERAL

This supplement supplies information necessary for the operation of the airplane when the optional oxygen system is installed. The information contained within this supplement is to be used in conjunction with the complete handbook.

This supplement has been "FAA Approved" as a permanent part of this handbook and must remain in this handbook at all times when the optional oxygen system is installed.

SECTION 2 - LIMITATIONS

- (a) No smoking allowed.
- (b) The aircraft is restricted to six occupants with two (2) oxygen units installed.
- (c) The aircraft is restricted to four occupants with one (1) oxygen unit installed.
- (d) Oxygen duration:

DURATION IN HOURS AT ALTITUDE

Persons Using Each Unit	5,000	10,000	15,000	20,000	25,000
1	10.6	6.3	4.7	3.8	3.3
2	5.3	3.2	2.4	1.9	1.7
3	3.5	2.1	1.6	1.3	1.1
4	2.7	1.6	1.2	.95	.8

NOTE

For six occupants maximum duration will be obtained with three (3) persons utilizing each unit. See above chart for number of persons vs duration (per unit).

---

**SECTION 3 - EMERGENCY PROCEDURES**

- (a) Time of useful consciousness at 25,000 feet is approximately 3 minutes.
- (b) If oxygen flow is interrupted as evidenced by the flow indicators or hypoxic indications;
  - (1) Install another mask unit.
  - (2) Install mask connection in an unused outlet if available.
  - (3) If flow is not restored, immediately descend to below 12,500 feet.

**SECTION 4 - NORMAL PROCEDURES**

**PREFLIGHT**

- (a) Check oxygen quantity.
- (b) Installation (Forward facing seating arrangement only)
  - (1) Remove middle center seat and secure oxygen units to seat by use of belts provided.
  - (2) Reinstall seat and secure seat by adjusting the middle seat belt tightly around seat aft of the oxygen units.
- (c) Installation (Club seating arrangement only)
  - (1) Install mounting base between center seats utilizing slotted receptacles for front attachment points and bolts for aft attachment points.
  - (2) Slide oxygen bottles into position on top of mounting base ensuring that all mounting lugs engage in the slotted receptacle and that the locking pin is in the raised position.
- (d) Turn on oxygen system and check flow indicators on all masks. Masks for the two aft seats are stowed in the seat pockets of the middle seats. All other masks are stowed in the oxygen system containers.

**IN-FLIGHT**

- (a) Adjust oxygen mask.
- (b) Turn on system.
- (c) Monitor flow indicators and quantity.

**CAUTION**

Use of oxygen unit is prohibited when gauge approaches red area.

**SECTION 5 - PERFORMANCE**

No changes to the basic performance provided by Section 5 of this Pilot's Operating Handbook are necessary for this supplement.

SUPPLEMENT 2A

FIXED OXYGEN SYSTEM INSTALLATION - SCOTT AVIATION PRODUCTS  
AMBASSADOR MARK III PART NUMBER 802889-03

SECTION 1 - GENERAL

This supplement supplies information necessary for the operation of the airplane when the optional fixed oxygen system is installed. The information contained within this supplement is to be used in conjunction with the complete handbook.

This supplement has been "FAA Approved" as a permanent part of this handbook and must remain in this handbook at all times when the optional fixed oxygen system is installed.

SECTION 2 - LIMITATIONS

- (a) No smoking allowed when oxygen system is in use.
- (b) Oxygen duration: (Bottle pressure 1850 PSI)

DURATION IN HOURS AT ALTITUDE  
(Based on 90% Consumption)

Persons Using System	5,000	10,000	15,000	20,000	25,000
1	7.4	7.7	8.1	8.3	8.5
2	3.7	3.9	4.1	4.2	4.3
3	2.5	2.6	2.7	2.8	2.8
4	1.9	1.9	2.0	2.1	2.1
5	1.5	1.5	1.6	1.7	1.7
6	1.2	1.3	1.4	1.4	1.4

SECTION 3 - EMERGENCY PROCEDURES

- (a) Time of useful consciousness at 25,000 feet is approximately 3 minutes.
- (b) If oxygen flow is interrupted as evidenced by the flow indicators or hypoxic indications;
  - (1) Install another mask unit.
  - (2) Install mask connection in an unused outlet if available.
  - (3) If flow is not restored, immediately descend to below 12,500 feet.

**SECTION 4 - NORMAL PROCEDURES**

**PREFLIGHT**

- (a) Check oxygen quantity.
- (b) Turn on oxygen system and check flow indicators on all masks. All masks are stored in the seat pockets of the front and middle seats.

**IN-FLIGHT**

- (a) Adjust oxygen mask.
- (b) Turn on system.
- (c) Monitor flow indicators and quantity.

**CAUTION**

Do not use oxygen system below 200 PSI to prevent contamination and/or moisture from entering depleted cylinder-regulator assembly. If cylinder has been depleted it must be removed and refurbished in accordance with the manufacturer's recommended procedures.

**SECTION 5 - PERFORMANCE**

No changes to the basic performance provided by Section 5 of this Pilot's Operating Handbook are necessary for this supplement.

SUPPLEMENT 3

AUTOCONTROL IIIB AUTOPILOT INSTALLATION

SECTION 1 - GENERAL

This supplement supplies information necessary for the operation of the airplane when the optional Piper AutoControl IIIB Autopilot is installed. The information contained within this supplement is to be used in conjunction with the complete handbook.

This supplement has been "FAA Approved" as a permanent part of this handbook based on EDO-AIRE Mitchell STC SA3024SW-D and must remain in this handbook at all times when the optional Piper AutoControl IIIB Autopilot is installed.

SECTION 2 - LIMITATIONS

- (a) Autopilot operation prohibited above 172 KIAS. (Autopilot Vmo)
- (b) Autopilot must be "OFF" for takeoff and landing.

SECTION 3 - EMERGENCY PROCEDURES

- (a) In an emergency the AutoControl IIIB can be disconnected by:
  - (1) Pushing the AP ON-OFF switch "OFF."
  - (2) Pulling the AP circuit breaker.
- (b) The autopilot can be overpowered at either control wheel.
- (c) An autopilot runaway, with a 3 second delay in the initiation of recovery while operating in climb, cruise or descending flight, could result in a 60° bank and 150 foot altitude loss.
- (d) An autopilot runaway, with a 1 second delay in the initiation of recovery, during an approach operation, coupled or uncoupled, could result in 18° and 20 foot altitude loss.
- (e) Emergency operation with optional NSD 360 and NSD 360A (HSI) - Slaved and/or Non-Slaved:

NSD 360

- (1) Appearance of HDG Flag:
  - a. Check air supply gauge (vac or pressure) for adequate air supply (4 in. Hg. min.).
  - b. Check compass circuit breaker.
  - c. Observe display for proper operation.
- (2) To disable heading card - pull circuit breaker and use magnetic compass for directional data.

NOTE

If heading card is not operational, autopilot should not be used.

- (3) With card disabled:
  - a. VOR and Glide Slope displays are still functional; use card set to rotate card to aircraft heading for correct picture.
  - b. Localizer - left-right information still usable. Flag information is disabled - compare needle with No. 2 indicator for valid left-right needle operation.
- (4) Slaving Failure - (i.e. failure to self-correct for gyro drift):
  - a. Check gyro slaving switch is set to No. 1 position.
  - b. Check for HDG Flag.
  - c. Check compass circuit breaker.
  - d. Reset heading card while observing slaving meter.
  - e. Select slaving amplifier No. 2 (gyro slaving switch is set to No. 2 position).
  - f. Reset heading card while checking slaving meter.
  - g. Switch to free gyro and periodically set card as unslaved gyro.

NSD 360A (Instrument with red-white striped NAV-HDG Flags)

- (1) The emergency procedures for the NSD 360A remain identical to those listed for the NSD 360 (above), except that the presence of the NAV Flag on a localizer frequency invalidates the NAV left-right information. Usable navigation data will be indicated in both VOR and Localizer modes by the absence of the NAV Flag, whether the card is disabled or not.
- (2) In the localizer mode the "TO-FROM" arrows may remain out of view, depending upon the design of the NAV converter used in the installation.

## SECTION 4 - NORMAL PROCEDURES

### PREFLIGHT

#### (a) AUTOPILOT

- (1) Place radio coupler in HDG mode (if installed) and place the AP "ON-OFF" switch to the "ON" position to engage roll section. Rotate roll command knob left and right and observe that control wheel describes a corresponding left and right turn, then center knob.
- (2) Set proper D.G. heading on D.G. and turn HDG bug to aircraft heading. Engage HDG mode rocker switch and rotate HDG bug right and left. Aircraft control wheel should turn same direction as bug. Grasp control wheel and manually override servo, both directions.

#### (b) RADIO COUPLER - (OPTIONAL)

- (1) Tune and identify VOR or VOT station. Position radio coupler to OMNI mode. Place autopilot and HDG switches to the ON position. Set HDG bug to aircraft heading and rotate OBS to cause OMNI indicator needle to swing left and right slowly. Observe that control wheel rotates in direction of needle movement.
- (2) Disengage AP "ON-OFF" switch. Reset radio coupler control to HDG.

### IN-FLIGHT

- (a) Trim airplane (ball centered).
- (b) Check air pressure or vacuum to ascertain that the directional gyro and attitude gyro are receiving sufficient air.

- (c) Roll Section:
- (1) To engage, center ROLL COMMAND knob, push AP "ON-OFF" switch to "ON" position. To turn, rotate ROLL COMMAND knob in desired direction. (Maximum angle of bank should not exceed 30°.)
  - (2) For heading mode, set directional gyro with magnetic compass. Push directional gyro HDG knob in, rotate bug to aircraft heading. Push console heading rocker (HDG) switch to "ON" position. To select a new aircraft heading, push D.G. heading knob "IN" and rotate, in desired direction of turn, to the desired heading.
- (d) Radio Coupling VOR-ILS with H.S.I. (Horizontal Situation Indicator) Type Instrument Display. (Optional)
- (1) VOR Navigation
    - a. Tune and identify VOR station. Select desired course by rotating CRS knob of H.S.I. (H.S.I. course knob).
    - b. Select OMNI mode on radio coupler.
    - c. Select HDG mode on autopilot console to engage coupler. Aircraft will turn to a 45° intercept angle to intercept the selected VOR course. Intercept angle magnitude depends on radio needle off course magnitude, 100% needle deflection will result in 45° intercept with the intercept angle diminishing as the needle offset diminishes.
    - d. NAV mode - NAV mode provides reduced VOR sensitivity for tracking weak, or noisy VOR signals. NAV mode should be selected after the aircraft is established on course.
  - (2) ILS-LOC Front Course
    - a. Set inbound, front, localizer course with H.S.I. course knob.
    - b. Select LOC-Normal on radio coupler to intercept and track inbound on the localizer. Select LOC-REV to intercept and track the localizer course outbound to the procedure turn area.
    - c. Select HDG mode on autopilot console to engage coupler.
  - (3) ILS - Back Course
    - a. Set inbound, front localizer course with H.S.I. course knob.
    - b. Select LOC-REV on radio coupler to intercept and track inbound on the back localizer course. Select LOC-NORM to intercept and track outbound on the back course to the procedure turn area.
    - c. Select HDG mode on autopilot console to engage coupler.
- (e) Radio Coupling - VOR/ILS with standard directional gyro. (Optional)
- Radio coupler operation in conjunction with a standard directional gyro and VOR/LOC display differs from operation with an integrated display (H.S.I.) only in one respect. The HDG bug is used as the radio course datum and therefore must be set to match the desired VOR course as selected on the OBS.
- (1) For VOR intercepts and tracking:

Select the desired VOR course and set the HDG bug to the same heading. Select OMNI mode on the coupler and HDG mode on the autopilot console.
  - (2) For ILS Front Course intercepts and tracking:

Tune the localizer frequency and place the HDG bug on the inbound, front course heading. Select LOC-NORM mode on the coupler and HDG mode on the autopilot console.

**(3) For LOC Back Course intercepts and tracking:**

Tune the localizer frequency and place the HDG bug on the inbound course heading to the airport. Select LOC-REV mode with coupler and HDG mode on the autopilot console.

**SECTION 5 - PERFORMANCE**

No changes to the basic performance provided by Section 5 of the Pilot's Operating Handbook are necessary for this supplement.



SUPPLEMENT 4

ALTIMATIC IIC AUTOPILOT INSTALLATION

SECTION 1 - GENERAL

This supplement supplies information necessary for the operation of the airplane when the optional AltiMatic IIC Autopilot is installed. The information contained within this supplement is to be used in conjunction with the complete handbook.

This supplement has been "FAA Approved" as a permanent part of this handbook based on EDO-AIRE Mitchell STC SA3023SW-D and must remain in this handbook at all times when the optional AltiMatic IIC Autopilot is installed.

SECTION 2 - LIMITATIONS

- (a) Autopilot operation prohibited above 172 KIAS. (Autopilot Vmo)
- (b) Autopilot must be "OFF" during takeoff and landing.
- (c) Autopilot operation not authorized with greater than 25° of flap extension.
- (d) Required placard P/N 13A660-1 "Conduct Trim Check prior to flight (see P/O/H)" to be installed in clear view of pilot.
- (e) During autopilot operation, the pilot must be in his seat with the safety belt fastened.

SECTION 3 - EMERGENCY PROCEDURES

This aircraft is equipped with a Master Disconnect/Interrupt Switch on the pilot's control wheel. When the switch button is depressed it will disconnect the autopilot. When depressed and held it will interrupt all Electric Elevator Trim Operations. Trim operations will be restored when the switch is released. If an autopilot or trim emergency is encountered, do not attempt to determine which system is at fault. Immediately depress and hold the Master Disconnect/Interrupt button. Turn off autopilot and trim master switch and retrim aircraft, then release the interrupt switch.

NOTE

During examination of this supplement, the pilot is advised to locate and identify the autopilot controls, the trim master switch and circuit breaker for both systems.

- (a) In the event of an autopilot malfunction the autopilot can be:  
(1) Overpowered at either control wheel.

**CAUTION**

Do not overpower autopilot pitch axis for periods longer than 3 seconds because the autotrim system will operate in a direction to oppose the pilot and will, thereby, cause an increase in the pitch overpower forces.

- (2) Disconnected by depressing the Master Disconnect/Interrupt Switch.  
(3) Disconnected by depressing the Trim Switch "AP OFF" bar.  
(4) Disconnected by pushing the roll rocker switch "OFF."
- (b) In the event of a trim malfunction:  
(1) Depress and hold the Master Trim Interrupt Switch.  
(2) Trim Master Switch - "OFF." Retrim aircraft as necessary using manual trim system.  
(3) Release Master Interrupt Switch - be alert for possible trim action.  
(4) Trim Circuit Breaker - Pull. Do not operate trim until problem is corrected.
- (c) If a trim runaway occurs with the autopilot operating, the above procedure will disconnect the autopilot which will immediately result in higher control wheel forces. Be prepared to manually retrim, as necessary to eliminate undesirable forces.
- (d) Altitude Loss During Malfunction:  
(1) An autopilot malfunction during climb, cruise or descent with a 3 second delay in recovery initiation could result in as much as 60° of bank and 200' of altitude loss.  
(2) Altitude loss - high altitude descent - 3 second delay in recovery could result in a 60° bank and a 420' altitude loss.  
(3) An autopilot malfunction during an approach with a 1 second delay in recovery initiation could result in as much as 20° of bank and 75' altitude loss. Maximum altitude loss measured in approach configuration gear down and operating either coupled or uncoupled, single or multi-engine.
- (e) Emergency Operation With Optional NSD 360 and NSD 360A (HSI) - Slaved and/or Non-Slaved:  
NSD 360  
(1) Appearance of HDG Flag:  
a. Check air supply gauge (vac or pressure) for adequate air supply (4 in. Hg. min.).  
b. Check compass circuit breaker.  
c. Observe display for proper operation.  
(2) To disable heading card - pull circuit breaker and use magnetic compass for directional data.

**NOTE**

If heading card is not operational, autopilot should not be used.

- (3) With card disabled:
  - a. VOR and Glide Slope displays are still functional; use card set to rotate card to aircraft heading for correct picture.
  - b. Localizer - left-right information still usable. Flag information is disabled - compare needle with No. 2 indicator for valid left-right needle operation.
- (4) Slaving Failure - (i.e. failure to self-correct for gyro drift):
  - a. Check gyro slaving switch is set to No. 1 position.
  - b. Check for HDG Flag.
  - c. Check compass circuit breaker.
  - d. Reset heading card while observing slaving meter.
  - e. Select slaving amplifier No. 2 (gyro slaving switch is set to No. 2 position).
  - f. Reset heading card while checking slaving meter.
  - g. Switch to free gyro and periodically set card as unslaved gyro.

NSD 360A (Instrument with red-white striped NAV-HDG Flags)

- (1) The emergency procedures for the NSD 360A remain identical to those listed for the NSD 360 (above), except that the presence of the NAV Flag on a localizer frequency invalidates the NAV left-right information. Usable navigation data will be indicated in both VOR and Localizer modes by the absence of the NAV Flag, whether the card is disabled or not.
- (2) In the localizer mode the "TO-FROM" arrows may remain out of view, depending upon the design of the NAV converter used in the installation.

(f) Single Engine Operations:

- (1) Engine failure during an autopilot approach operation: Disengage autopilot conduct remainder of approach manually.
- (2) Engine failure during go around: Disengage autopilot, retrim aircraft, perform normal aircraft engine out procedures then re-engage autopilot.
- (3) Engine failure during normal climb, cruise, descent: Retrim aircraft, perform normal aircraft engine out procedures.
- (4) Maintain aircraft yaw trim throughout all single engine operations.

## SECTION 4 - NORMAL PROCEDURES

### PREFLIGHT INSPECTION - AUTOPILOT

- (a) Roll Section
  - (1) Place Radio Coupler in "Heading" mode and place roll rocker switch "ON" to engage roll section. Rotate roll command knob left and right and observe that control wheel describes a corresponding left and right turn, then center knob.
  - (2) Set proper D.G. Heading on D.G. and turn Heading Bug to aircraft heading. Engage "Heading" mode rocker switch and rotate heading bug right and left. Aircraft control wheel should turn same direction as bug. Grasp control wheel and manually override servo, both directions.
  - (3) Disengage autopilot by depressing trim switch. Check aileron operation is free and autopilot is disconnected from controls.

(b) Pitch Section

- (1) Engage "Roll" rocker switch.
- (2) Center pitch command disc and engage "Pitch" rocker switch.
- (3) Rotate pitch command disc full DOWN and full UP and check that control wheel moves same direction. Check to see that servo can be overridden by hand at control wheel.

NOTE

Autopilot might not be able to raise elevators, on ground, without assistance from pilot.

- (4) Hold control wheel and disengage autopilot by pressing Master Autopilot Disconnect/Trim Interrupt Switch button. Check Roll and Pitch controls to assure autopilot has disconnected.

TRIM SYSTEM

General

This aircraft is equipped with a Command Trim System designed to withstand any type of single malfunction, either mechanical or electrical, without uncontrolled operation resulting. The preflight check procedure is designed to uncover hidden failures that might otherwise go undetected. Proper operation of the electric trim system is predicated on conducting the following preflight check before each flight. If the trim system fails any portion of the procedure, pull the trim circuit breaker out until trim system is repaired. Substitution of any trim system component for another model is not authorized. For emergency interrupt information, refer to Section 3 of this Supplement.

Command Electric Trim Switch

The Command Electric Trim Switch on the left hand portion of the pilot's control wheel has two functions:

- (1) When the top bar (AP OFF) is pressed, it disconnects the Autopilot.
- (2) When the top bar is pressed AND the rocker is moved forward, nose down trim will occur, when moved aft, nose up trim will occur.

(a) Preflight: Command Trim - Before Each Flight

- (1) Check trim circuit breaker - IN.
- (2) Trim Master Switch - ON.
- (3) AP OFF - Check normal trim operation - UP. Grasp trim wheel and check override capability. Check nose down operation. Recheck override.
- (4) Activate center bar only. Trim should not operate.
- (5) Without pressing center bar, move rocker fore and aft - trim should not operate with either separate action.

(b) Autotrim - Before Each Flight

- (1) AP ON - (Roll and Pitch Sections) Check automatic operation by activating autopilot pitch command UP then DN. Observe trim operation follows pitch command direction.

NOTE

In autopilot mode, there will be approximately a 3 second delay between operation of pitch command and operation of trim.

- (2) Press center bar (AP OFF) - release - check autopilot disengagement.
- (3) Rotate trim wheel to check manual trim operation. Reset to takeoff position prior to takeoff.

#### AUTOPILOT IN-FLIGHT PROCEDURE

- (a) Trim airplane (ball centered).
- (b) Check air pressure or vacuum to ascertain that the directional gyro and attitude gyro are receiving sufficient air.
- (c) Roll Section
  - (1) To engage - Center ROLL COMMAND knob, push ROLL rocker to "ON" position. To turn, rotate console ROLL knob in desired direction.
  - (2) For heading mode, set directional gyro with magnetic compass. Push directional gyro HDG knob in, rotate to select desired heading. Push console heading rocker (HDG) to "ON" position. (Maximum angle to bank will be 20° with heading lock engaged.)
- (d) Pitch Section (Roll section must be engaged prior to pitch section engagement).
  - (1) Center pitch trim indicator with the pitch command disc.
  - (2) Engage pitch rocker switch. To change attitude, rotate pitch command disc in the desired direction.
- (e) Altitude Hold

Upon reaching desired or cruising altitude, engage altitude hold mode rocker switch. As long as Altitude Hold mode rocker is engaged, aircraft will maintain selected altitude. For maximum passenger comfort, rate of climb or descent should be reduced to approximately 500 FPM prior to altitude hold engagement. For accurate Altitude Holding below 100 KIAS lower flaps one or two notches.

#### NOTE

Prior to disengaging Altitude Hold mode, rotate Pitch Command Disc to center.

- (f) Radio Coupling VOR-ILS with H.S.I. type instrument display. (Optional)
  - (1) VOR Navigation
    - a. Tune and identify VOR Station. Select desired course by rotating CRS knob of H.S.I.
    - b. Select OMNI mode on Radio Coupler.
    - c. Select HDG mode on autopilot console to engage coupler. Aircraft will turn to a 45° intercept angle to intercept the selected VOR course. Intercept angle magnitude depends on radio needle off - course magnitude, 100% needle deflection will result in 45° intercept angle, diminishing as the needle off-set diminishes.
    - d. NAV mode - NAV mode provides reduced VOR sensitivity for tracking weak, or noisy, VOR signals. NAV mode should be selected after the aircraft is established on course.

- (2) ILS-LOC Front Course
  - a. Set inbound, front, localizer course with H.S.I. course knob.
  - b. Select LOC-Normal on Radio Coupler to intercept and track inbound on the localizer. Select LOC-REV to intercept and track the localizer course outbound to procedure turn area.
  - c. Select HDG mode on autopilot console to engage coupler.
  
- (3) ILS - Back Course
  - a. Set inbound, front, localizer course with H.S.I. course knob.
  - b. Select LOC-REV, on radio coupler to intercept and track inbound on the back localizer course. Select LOC-NORM to intercept and track outbound on the back course to the procedure turn area.
  - c. Engage HDG mode on autopilot console to engage coupler.
  
- (g) Radio Coupling - VOR/ILS with standard directional gyro. (Optional)

Radio Coupler operation in conjunction with a standard directional gyro and VOR/LOC display differs from operation with an integrated display (H.S.I.) only in one respect. The HDG bug is used as the radio course datum and therefore must be set to match the desired VOR/ILS course as selected on the O.B.S.

  - (1) For VOR Intercepts and Tracking:

Select the desired VOR Course and set the HDG bug to the same heading. Select OMNI mode on the coupler and engage HDG mode on the autopilot console.
  - (2) For ILS Front Course Intercepts and Tracking:

Tune the localizer frequency and place the HDG bug on the inbound, front course heading. Select LOC-NORM mode on the coupler and engage HDG mode on the autopilot console.
  - (3) For LOC Back Course Intercepts and Tracking:

Tune the localizer frequency and place the HDG bug on the inbound course heading to the airport. Select LOC-REV mode on the coupler and engage HDG mode on the autopilot console.
  
- (h) Coupled Approach Operations
  - (1) VOR or LOC
    - a. After arrival at the VOR Station, track outbound to the procedure turn area as described in Section 4 (f) or (g) as appropriate. Slow to 100-105 KIAS while inbound to FAF and lower one or two notches of flaps (10° or 25°).
    - b. Use HDG mode and Pitch or Altitude Hold modes as appropriate during procedure turn.
    - c. At the F.A.F. inbound, return to pitch mode for control of descent and lower landing gear.
    - d. At the M.D.A. select altitude hold mode and add power for level flight. Monitor altimeter to assure accurate altitude control is being provided by the autopilot.
    - e. Go Around - For missed approach select desired pitch attitude with pitch command disc and disengage altitude hold mode. This will initiate the pitch up attitude change. Immediately add takeoff power and monitor Altimeter and rate of climb for positive climb indication. After climb is established, retract flaps and gear. Adjust attitude as necessary for desired airspeed and select HDG mode for turn from the VOR final approach course.

- (2) ILS - Front Course Approach With Glide Slope Capture. (Optional)
- a. Track inbound to LOM as described in Section 4 (f) or (g) above and in Altitude Hold mode.
  - b. Inbound to LOM slow to 100 to 105 KIAS and lower flaps one or two notches (10° or 25°).
  - c. Automatic Glide Slope capture will occur at Glide Slope intercept if the following conditions are met:
    1. Coupler in LOC-Normal mode.
    2. Altitude Hold mode engaged (Altitude Rocker on Console).
    3. Under Glide Slope for more than 20 seconds.
    4. Localizer radio frequency selected on NAV Receiver.
  - d. At Glide Slope Intercept immediately reduce power to maintain 100 KIAS on final approach and lower landing gear. Glide Slope capture is indicated by lighting of the green Glide Slope engage Annunciator Lamp and by a slight pitch down of the aircraft.
  - e. Monitor localizer and Glide Slope raw data throughout approach. Adjust power as necessary to maintain correct final approach airspeed. All power changes should be of small magnitude and smoothly applied for best tracking performance. Do not change aircraft configuration during approach while autopilot is engaged.
  - f. Conduct missed approach maneuver as described in (h) (1) e. above.

NOTE

Glide Slope Coupler will not automatically decouple from Glide Slope. Decoupling may be accomplished by any of the following means:

1. Disengage Altitude Mode.
2. Switch Radio Coupler to HDG Mode.
3. Disengage Autopilot.

SECTION 5 - PERFORMANCE

No changes to the basic performance provided by Section 5 of the Pilot's Operating Handbook are necessary for this supplement.

**THIS PAGE INTENTIONALLY LEFT BLANK**



SUPPLEMENT 5

AIR CONDITIONING INSTALLATION

SECTION 1 - GENERAL

This supplement supplies information necessary for the efficient operation of the airplane when the optional air conditioning system is installed. The information contained within this supplement is to be used "as described" in conjunction with the complete handbook.

This supplement has been "FAA Approved" as a permanent part of this handbook and must remain in this handbook at all times when the optional air conditioning system is installed.

SECTION 2 - LIMITATIONS

- (a) To insure maximum climb performance the air conditioner must be turned "OFF" manually prior to takeoff to disengage the compressor and retract the condenser door. Also the air conditioner must be turned "OFF" manually before the landing approach in preparation for a possible go-around.
- (b) Placards  
In full view of the pilot, in the area of the air conditioner controls when the air conditioner is installed:

"AIR CONDITIONER MUST BE OFF PRIOR TO TAKE-OFF  
AND LANDING AND SINGLE ENGINE OPERATION"

In full view of the pilot, beside the condenser door light:

"AIR COND DOOR OPEN"

SECTION 3 - EMERGENCY PROCEDURES

No changes to the basic Emergency Procedures provided by Section 3 of this Pilot's Operating Handbook are necessary for this supplement.

SECTION 4 - NORMAL PROCEDURES

Prior to takeoff, the air conditioner should be checked for proper operation as follows:

- (a) Check aircraft master switch "ON".
- (b) Turn the air conditioner control switch to "ON" and the fan switch to one of the operating positions - the "AIR COND DOOR OPEN" warning light will turn on, thereby indicating proper air conditioner condenser door actuation.

- (c) Turn the air conditioner control switch to "OFF" - the "AIR COND DOOR OPEN" warning light will go out, thereby indicating the air conditioner door is in the retracted position.
- (d) If the "AIR COND DOOR OPEN" light does not respond as specified above, an air conditioner system or indicator bulb malfunction is indicated and further investigation should be conducted prior to flight.

The above operational check may be performed during flight if an in flight failure is suspected.

The condenser door light is located to the left of the warning gear unsafe light in front of the pilot. The door light illuminates when the door is open and is off when the door is closed.

#### SECTION 5 - PERFORMANCE

Operation of the air conditioner will cause slight decreases in cruise speed and range. Power from the engine is required to run the compressor, and the condenser door, when extended, causes a slight increase in drag. When the air conditioner is turned off there is normally no measurable difference in climb, cruise or range performance of the airplane.

#### NOTE

To insure maximum climb performance the air conditioner must be turned off manually before takeoff to disengage the compressor and retract the condenser door. Also the air conditioner must be turned off manually before the landing approach in preparation for a possible go-around. The air conditioner must be off during all one engine inoperative operations.

Although the cruise speed and range are only slightly affected by the air conditioner operation, these changes should be considered in preflight planning. To be conservative, the following figures assume that the compressor is operating continuously while the airplane is airborne. This will be the case only in extremely hot weather.

- (a) The decrease in true airspeed is approximately 4 KTS at all power settings.
- (b) The decrease in range may be as much as 25 nautical miles for the 93 gallon capacity.
- (c) The decrease in range may be as as much as 35 nautical miles for the 123 gallon capacity.

The climb performance is slightly affected by the air conditioner operation. A decrease in the rate of climb of as much as 80 fpm can be expected at all altitudes with the air conditioner operating.

SUPPLEMENT 6

KFC 200 AUTOMATIC FLIGHT CONTROL SYSTEM  
(WITH FLIGHT DIRECTOR INSTALLATION)

SECTION 1 - GENERAL

This manual is to acquaint the pilot with the operation of the KFC 200 Automatic Flight Control System with optional Flight Director as installed in the PA-34-200T Seneca II. The airplane must be operated within the limitations herein specified.

This supplement has been "FAA Approved" as a permanent part of this handbook based on King STC SA1147CE and must remain in this handbook at all times when the optional King KFC 200 Automatic Flight Control System is installed.

The KFC 200 is certified in this airplane with two axis control, pitch and roll. The system may be operated as a flight director alone with the pilot steering the airplane to the flight director command presentation or the autopilot can be engaged to steer the airplane to the flight director command presentation.

The airplane is equipped with an electric trim system which is controlled by pilot operation of the trim switch.

The autopilot uses the electric trim to accomplish automatic trimming to unload the autopilot elevator servo so that autopilot disengagement does not result in transient airplane motion. An autotrim/electric pitch trim monitor is provided in the autopilot. Autotrim and/or electric pitch trim faults are visually annunciated on the Mode Annunciator and accompanied by an audible warning.

ABBREVIATIONS

ALT	Altitude or Altitude Hold
AP	Autopilot
APPR	Approach
ARM	System Arm for Capture
BC	Back Course
CDI	Course Deviation Indicator or Control
CPLD	Coupled
DISC	Disconnect
FDI	Flight Director Indicator
FCS	Flight Control System
FD	Flight Director
GA	Go Around
HDG	Heading Select
NAV	Navigation
PAH	Pitch Attitude Hold
PNI	Pictorial Navigation Indicator

**SECTION 2 - LIMITATIONS**

- (a) During autopilot operation, pilot must be seated at the controls with seat belt fastened. Operation is restricted to left side pilot position.
- (b) Maximum speed for autopilot operation is 173 KIAS.
- (c) The maximum altitude for operation of the autopilot has not been determined. The maximum altitude flight tested was 24,000 feet.
- (d) Do not extend flaps beyond 25° during autopilot operation.
- (e) The autopilot must be disengaged during takeoff and landing.
- (f) System approved for Category I operation only (APPR or BC selected).
- (g) Autopilot attitude command limits:
  - Pitch ±15
  - Roll ±25
- (h) Placards:

Location - Pilot's control wheel, left horn:

AP            TRIM  
DISC        INTERRUPT

- Pilot's control wheel, left horn:

CWS

- Pilot's control wheel, left horn:

TRIM UP/DN

- Left throttle lever:

GO AROUND

**SECTION 3 - EMERGENCY PROCEDURES**

- (a) **AUTOPILOT DISENGAGEMENT**  
Disengage the autopilot and/or prevent engagement by:
  - (1) Pilot's DISC switch.
  - (2) AP engage lever on MODE CONTROLLER.
  - (3) Pulling the autopilot circuit breaker.
  - (4) Turning BAT-MASTER switch OFF.
  - (5) Turning RADIO POWER switch OFF.

(b) AUTOMATIC AUTOPILOT DISENGAGEMENT

Any of the following will cause the autopilot to automatically disengage:

- (1) External power failure.
- (2) Actuating manual electric trim.
- (3) Internal Flight Control System failure.
- (4) With KCS 55A system a loss of compass valid, (displaying HDG flag) disengages the AP and FD when a mode using heading information is engaged. With compass flag present only FD and vertical modes can be selected.

(c) ELECTRIC PITCH TRIM

Electric pitch trim can be disengaged by pressing AP and TRIM DISC switch and holding it down until recovery can be made then turn off RADIO POWER and manually retrim the airplane using the manual trim control wheel. After the airplane is trimmed out pull the trim breaker and turn the RADIO POWER switch back on.

(d) MAXIMUM ALTITUDE LOSSES DUE TO AUTOPILOT MALFUNCTION

- |                            |          |
|----------------------------|----------|
| (1) Cruise, Climb, Descent | 400 feet |
| (2) Maneuvering            | 100 feet |
| (3) APPR                   | 50 feet  |
| (4) SE APPR                | 50 feet  |

CAUTION

WHEN THE AUTOPILOT IS ENGAGED, MANUAL APPLICATION OF A FORCE TO THE PITCH AXIS OF THE CONTROL WHEEL FOR A PERIOD OF THREE SECONDS OR MORE WILL RESULT IN THE AUTOTRIM SYSTEM OPERATING IN THE DIRECTION TO CREATE A FORCE OPPOSING THE PILOT. THIS OPPOSING MISTRIM FORCE WILL CONTINUE TO INCREASE, AS LONG AS THE PILOT APPLIES A FORCE TO THE CONTROL WHEEL, AND WILL ULTIMATELY OVERPOWER THE AUTOPILOT. IF THE AUTOPILOT IS DISENGAGED UNDER THESE CONDITIONS, THE PILOT MAY BE REQUIRED TO EXERT CONTROL FORCES IN EXCESS OF 50 POUNDS TO MAINTAIN THE DESIRED AIRCRAFT ATTITUDE. THE PILOT WILL HAVE TO MAINTAIN THIS CONTROL FORCE WHILE HE MANUALLY RETRIMS THE AIRCRAFT.

(e) ENGINE FAILURE (Coupled)

- (1) Disengage AP
- (2) Follow basic Airplane Flight Manual single engine procedures.
- (3) Airplane rudder axis must be manually trimmed prior to engaging autopilot for single-engine operations.

CAUTION

IF RUDDER TRIM CANNOT BE MAINTAINED WHEN POWER IS CHANGED DURING A SINGLE ENGINE COUPLED APPROACH, DISENGAGE AUTOPILOT AND CONTINUE APPROACH MANUALLY.

CAUTION

AT AIRSPEEDS BELOW 96 KIAS, RAPID POWER APPLICATION MAY CAUSE A PRONOUNCED PITCH UP ATTITUDE OF 20° OR MORE.

SECTION 4 - NORMAL PROCEDURES

- (a) The BAT-MASTER switch function is unchanged and can be used in an emergency to shut off all electrical power while the problem is isolated.
- (b) The RADIO POWER switch supplies power to the avionics bus bar of the radio circuit breakers, AP and TRIM circuit breakers.
- (c) The KFC 200 is controlled by the following circuit breakers:

AUTOPILOT - This supplies power to the KC 295 Flight Computer, KA 285 Ann., KI 256 FDI if used, and both AP servos.

FCS MASTER - This in conjunction with the radio power switch supplies power to the avionics bus.

COMPASS SYSTEM - This supplies power to the KCS 55A/55 Compass System.

PITCH TRIM - This supplies power to the FCS Trim System and manual electric trim.

- (d) PILOT'S CONTROL WHEEL SWITCH FUNCTIONS

AP DISC/TRIM INTERRUPT - This emergency disconnect switch will disengage the AP, interrupt the power to the electric trim system, and disconnect all FD Modes. To resume AP control, a FD Mode and the AP lever on the Mode Controller must be re-engaged. In the event of electric trim or autotrim failure, the switch can be held depressed, which removes all power from the trim system to allow the pilot time to turn off the RADIO POWER switch and pull the (PITCH TRIM) circuit breaker.

CWS - This switch when depressed and held will allow the pilot to manually fly the airplane without disengaging the AP. When the switch is released the AP will resume control, (within the pitch and roll attitude limits). The CWS switch will resync the FD in PAH, or ALT hold and will transfer the GA mode to PAH. When the CWS is held depressed Manual Electric Trim may be operated without disengaging the AP.

**MANUAL PITCH TRIM** - The operation of the manual electric trim switch on the pilot's control wheel will disengage the AP lever switch on the Mode Controller. (Except when CWS switch is held depressed as previously noted.)

**GA** - The GA switch is located on the throttle and the operation of switch will indicate a fixed angle of climb of 6° on the FD. Selection of the GA Mode when in the APPR or NAV CPLD Mode will disengage the mode and revert to the FD, (wings level) mode for lateral steering, on models with serial numbers 34-8070021 and below. The AP if engaged will remain engaged and follow the pitch command to climb at the fixed angle.

On models with serial numbers 34-8070022 and up, the AP if engaged will disengage, the AP may be engaged/reengaged with the GA Mode selected and will follow the pitch command to climb at the fixed angle.

(e) **FCS WARNING FLAGS AND ANNUNCIATORS DESIGNATION AND OPERATION**

**FD** - This warning flag mounted in the KI 255 Flight Director Indicator will be in view whenever any of the following conditions are missing: KC 295 internal power valid, VG excitation valid, adapter board valid, or a FD mode not selected. (The KI 256 Flight Director Indicator does not have a warning flag. However, the command bars will be biased out of view whenever the system is invalid or a FD mode is not engaged.)

**HDG/PWR\*** - This warning flag mounted in the Pictorial Navigation Indicator will be in view whenever the directional gyro information is invalid. If a HDG invalid occurs with either NAV, APPR, or HDG modes selected the AP and/or FD is disengaged. Basic FD mode may then be re-engaged along with any vertical mode and the AP re-engaged. This flag is labeled HDG in the KCS 55A Compass System.

**TRIM** - The TRIM warning light, located in the lower right corner of the annunciator panel, will flash and be accompanied by an audible warning whenever autotrim and/or manual electric pitch trim failures occur. Trim servo motor running without a command is monitored on both trim modes. Trim servo motor not running when commanded to run, and the trim servo motor running in the wrong direction are monitored on Autotrim only. The TRIM warning light flashes four times and the audible warning sounds when the test switch on the Mode Controller is depressed.

**GS INVALID** - The G S valid (G S pointer being in view on KI 525) has to be present before G S may couple. If, after G S CPLD, the valid is lost, the system will flash the G S Annunciator and revert from G S CPLD to PAH. If the G S valid returns the system will revert back to G S CPLD.

**NAV FLAG** - The Nav or APPR Modes (ARM or CPLD) may be selected and will function with or without a Nav warning flag present.

**AP Disconnect Alert** - The Autopilot Disconnect Alerter will sound an audible warning for approximately 2 seconds whenever the auto-pilot engage lever on the KC 290 Mode Controller is disengaged, on models with serial numbers 34-8070022 and up only.

\*This warning flag is labeled PWR in the KCS 55 Compass System. All modes may be selected and will function with or without a PWR warning flag present.

- (f) BEFORE ENGAGING FLIGHT CONTROL SYSTEM
- (1) Check that all circuit breakers for the system are in.
  - (2) Allow sufficient time for gyros to come up to speed and system warm-up. (3-4 minutes)
- (g) PREFLIGHT CHECK (Run prior to each flight.)
- (1) With no modes engaged and all valid flags retracted, depress the test button on the Mode Controller. All mode annunciators will be illuminated on the annunciator panel and the red autotrim failure light will flash. At least four or more flashes must be observed to indicate proper operation of the autotrim/manual electric trim feature and an audible warning should sound. The three marker lights will also illuminate during test if the airplane uses the KA 285 as a remote marker indicator.
  - (2) Engage the FD then engage AP, depress the CWS switch, center the flight controls and release CWS. Apply force to the controls to determine if the AP can be overpowered.
  - (3) Check operation of the pilot's control wheel switch functions.
  - (4) Disengage the AP and run the following manual electric trim checks.
    - a. Trim breaker IN.
    - b. Run the trim up and down to check normal trim operation in both directions.
    - c. Run the trim from stop to stop. The time required shall be  $39 \pm 5$  seconds.
    - d. Grasping the manual trim wheel, run the trim both up and down and check overpower capability.
    - e. Press the AP DISC/TRIM INTERRUPT switch down and hold. The manual electric trim will not operate either up or down.
  - (5) Engage the FD and AP and put in a pitch up command using the vertical trim switch on the KC 290 Mode Controller. Hold the control column from moving and observe the autotrim run in the nose-up direction after approximately a three second delay. Use the vertical trim switch and put in a nose-down command. Hold the control column and observe the autotrim run in the nose-down direction after approximately three seconds.
  - (6) Engage the HDG mode and AP. Set the HDG bug to command a right turn. The control wheel will rotate clockwise. Set the HDG bug to command a left turn. The control wheel will rotate counterclockwise.

CAUTION

DISENGAGE THE AP AND CHECK THAT THE AIRPLANE  
MANUAL PITCH TRIM IS IN THE TAKEOFF POSITION  
PRIOR TO TAKE-OFF.

- (h) IN-FLIGHT OPERATION
- (1) Engage Procedure:

After take-off, clean up airplane and establish climb. Engage the FD mode first, monitor flight controls and engage AP. The pitch attitude will lock on any attitude up to  $15^\circ$  pitch attitude. Engaging the CWS switch allows the pilot to momentarily revert to manual control, while retaining his previous modes, except GA, and conveniently resuming that profile at his discretion.
  - (2) Disengage Procedure:

Check the airplane trim by monitoring the command bars before disengaging AP. While monitoring the flight controls disengage the system by one of the following methods: Depressing the pilot's disc. switch, operating the manual trim switch or operating the AP engage lever on the Mode Controller. The AP light on the annunciator panel will flash at least four times and remain off to indicate the AP is disengaged. To deactivate the Flight Director System, depress the FD switch on the Mode Controller or press the AP and Trim Disconnect switch.



- (3) **Flight Director Mode:**  
The FD must be engaged before the AP can be engaged. The FD mode alone indicates PAH and wings level. The pilot may choose to fly the FD manually without the AP engaged by depressing the FD switch on the Mode Controller and selecting any of the other modes he wishes to follow. The FD may be disengaged by depressing the FD switch on the MODE CONTROLLER at any time the AP is not engaged or by pressing the AP and Trim Disconnect switch with or without the AP engaged. FD engagement is displayed on the annunciator panel.

NOTE

THE VERTICAL TRIM SWITCH (LOCATED ON THE KC 290 MODE CONTROLLER PANEL) MAY BE USED TO TRIM THE PITCH ATTITUDE AT A RATE OF ONE DEGREE PER SECOND.

- (4) **Altitude Hold Mode:**  
When the ALT switch on the Mode Controller is pressed the airplane will maintain the pressure altitude existing at the time the switch is depressed. For smooth operation, engage the ALT at no greater than 500 feet per minute climb/descent. The ALT will automatically disengage when Glideslope couples or the go-around switch is depressed. ALT hold may be turned off at any time by depressing the ALT switch. ALT engagement is displayed on the annunciator panel.

NOTE

THE VERTICAL TRIM SWITCH (LOCATED ON THE KC 290 MODE CONTROLLER PANEL) MAY BE USED TO CHANGE OR TRIM THE ALTITUDE UP OR DOWN AT 500 FPM WITHOUT DISENGAGING THE MODE.

- (5) **Heading Mode:**  
Set the heading bug to the desired heading on the PNI, depress the HDG switch on the Mode Controller and HDG will be displayed on the annunciator panel. The airplane will turn to the heading selected and hold. The pilot may then choose any new heading by merely setting the bug on a new heading. The airplane will automatically turn in the direction the heading bug is turned. To disengage the HDG Mode, depress the HDG switch on the MODE CONTROLLER and observe the HDG light go out on the annunciator panel. The HDG Mode will automatically disengage when APPR or NAV CPLD is achieved.

- (6) The navigation mode may be selected by tuning the NAV receiver to the desired frequency, setting the CDI to the desired radial and depressing the NAV switch on the MODE CONTROLLER. If the NAV switch is engaged with a centered needle on the CDI, the mode will go directly to NAV CPLD as displayed on the annunciator panel. If a condition requiring a capture exists at mode engagement, the pilot is required to set up an intercept angle using either HDG or FD mode. NAV may be disengaged by depressing NAV switch or by engaging HDG or APPR when in NAV CPLD.

CAUTION

THE NAV MODE OF OPERATION WILL CONTINUE TO PROVIDE AIRPLANE CONTROL WITHOUT A VALID VOR/LOC SIGNAL (NAV FLAG IN VIEW).

- (7) Approach Mode:  
To select the approach mode, tune the appropriate VOR or LOC frequency and depress the APPR switch on the MODE CONTROLLER. The annunciator will indicate APPR ARM until intercepting the course when it will automatically couple and track. The system can intercept at any angle and will always turn toward the course pointer. See approach procedure for more detail. Approach mode can be disengaged by depressing the APPR switch on the MODE CONTROLLER, by depressing GA switch on the left engine throttle control, or by engaging HDG or NAV when in APPR CPLD. The annunciator panel indicates the status of the approach mode.

CAUTION

THE APPR MODE OF OPERATION WILL CONTINUE TO PROVIDE AIRPLANE CONTROL WITHOUT A VALID VOR/LOC SIGNAL (NAV FLAG IN VIEW).

- (8) Back Course Mode:  
For back course (BC) operation, proceed as for normal approach mode, but engage BC after selecting APPR. The BC switch reverses the signals in the computer and cannot be engaged without a LOC frequency selected. BC status is indicated on the annunciator panel. BC mode can be disengaged by depressing either the BC, APPR, or GA switches, or by selecting other than a LOC frequency on the NAV receiver.
- (9) Trim Up/Dn:  
Operation of the vertical trim switch on the Mode Controller provides a convenient means of adjusting the ALT hold or PAH angle function without disengaging the mode.

- (10) Go Around Mode (GA):

The GA mode may be engaged at any time by depressing the GA switch on the left engine throttle. GA will illuminate on the annunciator panel indicating mode status. The GA mode provides a fixed pitch up angle that will command the best rate of climbout for single engine performance, on models with serial numbers 34-8070021 and below, the AP if engaged will remain engaged. GA will cancel all other vertical modes as well as APPR or NAV CPLD.

On models with serial numbers 34-8070022 and up, the AP if engaged will disengage. GA will cancel all other vertical modes as well as APPR or NAV CPLD.

(i) VOR PROCEDURES

- (1) Tune NAV receiver to appropriate frequency.
- (2) Set desired Heading with the HDG BUG to intercept radial and engage HDG and AP.
- (3) Select desired radial and engage NAV. The airplane will remain on HDG as indicated on the annunciator panel and ARM on the NAV mode. When the airplane intercepts the beam the system will automatically couple and track in NAV mode and indicate CPLD on the annunciator panel.
- (4) A new course may be selected over the VOR station when operating in the NAV mode, by selecting a new radial when the To-From indication changes.
- (5) For VOR approach, see approach procedure.

(j) APPROACH PROCEDURES

- (1) Tune ILS or VOR.
- (2) Set CDI for inbound course.
- (3) Set Heading Bug and engage HDG to intercept course beam at any angle.
- (4) Engage APPR and note APPR ARM on the annunciator panels.
- (5) When airplane approaches beam APPR will couple, HDG will decouple, airplane will track LOC or VOR, and CPLD will illuminate on the annunciator panel.
- (6) When the glideslope beam is intercepted, the glideslope (GS) will couple automatically and indicates GS on the annunciator panel. If the ALT MODE was engaged prior to intercepting the glideslope, it will automatically disengage when GS couples. Airplane will now track LOC and GS. Adjust throttles to control speed on descent. Set HDG bug for missed approach but do not engage HDG.

NOTE

Operation of marker test function after APPR CPLD will reduce the flight control system gains. If this should occur, the APPR switch should be recycled.

(7) Landing or missed approach

- a. Disengage AP and land.
- b. Go-Around by depressing GA switch on left engine throttle. The AP will remain engaged and the FD will indicate a climb. APPR Mode may be used for a straight away missed approach or HDG may be engaged to turn to the missed approach heading.

On models with serial numbers 34-8070021 and below, the AP will remain engaged and the FD will indicate a climb. APPR Mode may be used for a straight away missed approach or HDG may be engaged to turn to the missed approach heading.

On models with serial numbers 34-8070022 and up, the AP, if engaged, will disengage and the FD will indicate a climb. The AP may be engaged/re-engaged after the airplane is established in the Go Around attitude and the airplane in trim. The APPR Mode may be used for a straight away missed approach or HDG may be engaged to turn to the missed approach heading.

(k) BACK COURSE PROCEDURE

Same as front course except that BC is engaged after APPR is engaged and the airplane must be set for descent manually by holding the vertical trim control DN on the Mode Controller or by establishing the desired PAH using the CWS.

**SECTION 5 - PERFORMANCE**

Installation of the King KFC 200 Flight Control System does not effect the basic performance information presented by Section 5 of this handbook.

SUPPLEMENT 7

KFC 200 AUTOMATIC FLIGHT CONTROL SYSTEM  
(WITHOUT FLIGHT DIRECTOR INSTALLATION)

SECTION 1 - GENERAL

This manual is to acquaint the pilot with the operation of the KFC 200 Automatic Flight Control System as installed in the Seneca II. The airplane must be operated within the limitations herein specified.

This supplement has been "FAA Approved" as a permanent part of this handbook based on King STC SA1147CE and must remain in this handbook at all times when the optional King KFC 200 Automatic Flight Control System is installed.

The KFC 200 is certified in this airplane with two axis control, pitch and roll.

The airplane is equipped with an electric trim system which is controlled by pilot operation of the trim switch. The autopilot uses the electric trim to accomplish automatic trimming to unload the autopilot elevator servo so that autopilot disengagement does not result in transient airplane motion. An autotrim/electric pitch trim monitor is provided in the autopilot. Autotrim and/or electric pitch trim faults are visually annunciated on the Mode Annunciator and accompanied by an audible warning.

ABBREVIATIONS

ALT	Altitude or Altitude Hold
AP	Autopilot
APPR	Approach
ARM	System Arm for Capture
BC	Back Course
CDI	Course Deviation Indicator or Control
CPLD	Coupled
DISC	Disconnect
FCS	Flight Control System
GA	Go Around
HDG	Heading Select
NAV	Navigation
PAH	Pitch Attitude Hold
PNI	Pictorial Navigation Indicator

**SECTION 2 - LIMITATIONS**

- (a) During autopilot operation, pilot must be seated at the controls with seat belt fastened. Operation is restricted to left side pilot position.
- (b) Maximum speed for autopilot operation is 173 KIAS.
- (c) The maximum altitude for operation of the autopilot has not been determined. The maximum altitude flight tested was 24,000 feet.
- (d) Do not extend flaps beyond 25° during autopilot operation.
- (e) The autopilot must be disengaged during takeoff and landing.
- (f) System approved for Category I operation only (APPR or BC selected).
- (g) Autopilot attitude command limits:
  - Pitch  $\pm 15^\circ$
  - Roll  $\pm 25^\circ$
- (h) Placards:

Location - Pilot's control wheel, left horn:

AP                      TRIM  
DISC                    INTERRUPT

- Pilot's control wheel, left horn:

CWS

- Pilot's control wheel, left horn:

TRIM UP/DN

- Left throttle lever:

GO AROUND

**SECTION 3 - EMERGENCY PROCEDURES**

- (a) **AUTOPILOT DISENGAGEMENT**  
Disengage the autopilot and/or prevent engagement by:
  - (1) Pilot's DISC switch.
  - (2) AP engage lever on MODE CONTROLLER.
  - (3) Pulling the AUTOPILOT circuit breaker.
  - (4) Turning BAT-MASTER switch OFF.
  - (5) Turning RADIO POWER switch OFF.

(b) AUTOMATIC AUTOPILOT DISENGAGEMENT

Any of the following will cause the autopilot to automatically disengage:

- (1) External power failure.
- (2) Actuating manual electric trim.
- (3) Internal Flight Control System failure.
- (4) With KCS 55A system a loss of compass valid (displaying HDG flag) disengages the AP when a mode using heading information is engaged. With compass flag present only AP and vertical modes can be selected.

(c) ELECTRIC PITCH TRIM

Electric pitch trim can be disengaged by pressing AP DISC/TRIM INTERRUPT switch and holding fully down until recovery can be made then turn off RADIO POWER and manually retrim the airplane using the manual trim control wheel. After the airplane is trimmed out pull the trim breaker and turn the RADIO POWER switch back on.

(d) MAXIMUM ALTITUDE LOSSES DUE TO AUTOPILOT MALFUNCTION

- |                            |          |
|----------------------------|----------|
| (1) Cruise, Climb, Descent | 400 feet |
| (2) Maneuvering            | 100 feet |
| (3) APPR                   | 50 feet  |
| (4) SE APPR                | 50 feet  |

CAUTION

WHEN THE AUTOPILOT IS ENGAGED, MANUAL APPLICATION OF A FORCE TO THE PITCH AXIS OF THE CONTROL WHEEL FOR A PERIOD OF THREE SECONDS OR MORE WILL RESULT IN THE AUTOTRIM SYSTEM OPERATING IN THE DIRECTION TO CREATE A FORCE OPPOSING THE PILOT. THIS OPPOSING MISTRIM FORCE WILL CONTINUE TO INCREASE, AS LONG AS THE PILOT APPLIES A FORCE TO THE CONTROL WHEEL, AND WILL ULTIMATELY OVERPOWER THE AUTOPILOT. IF THE AUTOPILOT IS DISENGAGED UNDER THESE CONDITIONS, THE PILOT MAY BE REQUIRED TO EXERT CONTROL FORCES IN EXCESS OF 50 POUNDS TO MAINTAIN THE DESIRED AIRCRAFT ATTITUDE. THE PILOT WILL HAVE TO MAINTAIN THIS CONTROL FORCE WHILE HE MANUALLY RETRIMS THE AIRCRAFT.

- (e) ENGINE FAILURE (Coupled)
  - (1) Disengage AP.
  - (2) Follow basic Airplane Flight Manual single engine procedures.
  - (3) Airplane rudder axis must be manually trimmed prior to engaging autopilot for single engine operations.

**CAUTION**

IF RUDDER TRIM CANNOT BE MAINTAINED WHEN POWER IS CHANGED DURING A SINGLE ENGINE COUPLED APPROACH, DISENGAGE AUTOPILOT AND CONTINUE APPROACH MANUALLY.

**CAUTION**

AT AIRSPEEDS BELOW 96 KIAS, RAPID POWER APPLICATION MAY CAUSE A PRONOUNCED PITCH UP ATTITUDE OF 20 OR MORE.

**SECTION 4 - NORMAL PROCEDURES**

- (a) The BAT MASTER switch function is unchanged and can be used in an emergency to shut off all electrical power while the problem is isolated.
- (b) The RADIO POWER switch supplies power to the avionics bus bar of the radio circuit breakers, AP and TRIM circuit breakers.
- (c) The KFC 200 is controlled by the following circuit breakers:

**AUTOPILOT** - This supplies power to the KC 295 Flight Computer, KA 285 Annunciator, KC 292 Mode Controller, and both AP servos.

**FCS MASTER** - This in conjunction with the RADIO POWER switch, supplies power to the avionics bus.

**COMPASS SYSTEM** - This supplies power to the KCS 55A/55 Compass System.

**PITCH TRIM** - This supplies power to the FCS Trim System and manual electric trim.

- (d) PILOT'S CONTROL WHEEL SWITCH FUNCTIONS

**AP DISC/TRIM INTERRUPT** - This emergency disconnect switch will disengage the AP and interrupt the power to the electric trim system. To resume AP control, the AP lever on the Mode Controller must be re-engaged. In the event of electric trim or autotrim failure, the switch can be held depressed which removes all power from the trim system to allow the pilot time to turn off the RADIO POWER switch and pull the (PITCH TRIM) circuit breaker.



CWS - This switch when depressed and held will allow the pilot to manually fly the airplane without disengaging the AP. When the switch is released the AP will resume control (within the pitch and roll attitude limits). The CWS switch will resync the AP in PAH or ALT hold and will transfer the GA mode to PAH. When the CWS is held depressed Manual Electric Trim may be operated without disengaging the AP.

MANUAL PITCH TRIM - Operation of the manual electric trim switch on the pilot's control wheel will disengage the AP lever switch on the Mode Controller. (Except when CWS switch is held depressed as previously noted.)

GA - The GA switch is located on the throttle. On models with serial numbers 34-8070021 and below, the operation of the switch will cause the AP to command a fixed angle of climb of 6°. Selection of the GA Mode when in the APPR or NAV CPLD Mode will disengage the mode and revert to the AP (wings level) mode for lateral steering. On models with serial numbers 34-8070022 and up, the AP if engaged will disengage.

(e) FCS WARNING FLAGS AND ANNUNCIATORS DESIGNATION AND OPERATION

HDG/PWR\* - This warning flag mounted in the pictorial Navigation Indicator will be in view whenever the directional gyro information is invalid. If a HDG invalid occurs with either NAV, APPR or HDG modes selected, the AP is disengaged. Basic AP mode may then be re-engaged along with any vertical mode. This flag is labeled HDG in the KCS 55A Compass System.

TRIM - The TRIM Warning light, located in the lower right corner of the annunciator panel, will flash and be accompanied by an audible warning whenever autotrim and/or manual electric pitch trim failures occur. Trim servo motor running without a command is monitored on both trim modes. Trim servo motor not running when commanded to run, and the trim servo motor running in the wrong direction are monitored on Autotrim only. The TRIM warning light flashes four times and the audible warning sounds when the test switch on the Mode Controller is depressed.

GS INVALID - The GS valid (GS pointer being in view on KI 525) has to be present before GS may couple. If, after GS CPLD, the valid is lost, the system will flash the GS Annunciator and revert from GS CPLD to PAH. If the GS valid returns, the system will revert back to GS CPLD.

NAV FLAG - The NAV or APPR Modes (ARM or CPLD) may be selected and will function with or without a NAV warning flag present.

AP Disconnect Alert - The Autopilot Disconnecter Alerter will sound an audible warning for approximately 2 seconds whenever the autopilot engage lever on the KC 290 Mode Controller is disengaged, on models with serial numbers 34-8070022 and up only.

(f) BEFORE ENGAGING FLIGHT CONTROL SYSTEM

- (1) Check that all circuit breakers for the system are in.
- (2) Allow sufficient time for gyros to come up to speed and system warm-up. (3-4 minutes)

\*This warning flag is labeled PWR in the KCS 55 Compass System. All modes may be selected and will function with or without a PWR warning flag present.

- (g) PREFLIGHT CHECK (Run prior to each flight)
- (1) With no modes engaged and all valid flags retracted, depress the test button on the Mode Controller. All mode annunciators except FD will be illuminated on the annunciator panel and the red autotrim failure light will flash and aural alert sound. At least four or more flashes and beeps must be observed to indicate proper operation of the autotrim/manual electric trim feature. The three marker lights will also illuminate during test if the airplane uses the KA 285 as a remote marker indicator.
  - (2) Engage the AP, depress the CWS switch, center the flight controls and release CWS. Apply force to the controls to determine if the AP can be overpowered.
  - (3) Check operation of the pilot's control wheel switch functions.
  - (4) Disengage the AP and run the following manual electric trim checks:
    - a. Trim breaker IN.
    - b. Run the trim up and down to check normal trim operation in both directions.
    - c. Run the trim from stop-to-stop. The time required shall be  $39 \pm 5$  seconds.
    - d. Grasping the manual trim wheel, run the trim both up and down and check overpower capability.
    - e. Press the AP DISC/TRIM INTERRUPT switch down and hold. The manual electric trim will not operate either up or down.
  - (5) Engage the AP and put in a pitch up command using the vertical trim switch on the KC 292 Mode Controller. Hold the control column from moving and observe the autotrim run in the nose up direction after approximately a three second delay. Use the vertical trim switch and put in a nose down command. Hold the control column and observe the autotrim run in the nose down direction after approximately three seconds.
  - (6) Engage the AP and HDG modes. Set the HDG bug to command a right turn. The control wheel will rotate clockwise. Set the HDG bug to command a left turn. The control wheel will rotate counterclockwise.

**CAUTION**

**DISENGAGE THE AP AND CHECK THAT THE AIRPLANE  
MANUAL PITCH TRIM IS IN THE TAKEOFF POSITION  
PRIOR TO TAKEOFF.**

- (h) IN-FLIGHT PROCEDURE
- (1) Engage Procedure:

After takeoff, clean up airplane and establish climb. Monitor flight controls and engage AP. The pitch attitude will lock on any attitude up to 15° pitch attitude. Engaging the CWS switch allows the pilot to momentarily revert to manual control, while retaining his previous modes, except GA, and conveniently resume that profile at his discretion.
  - (2) Disengage Procedure:

While monitoring the flight controls, disengage the system by one of the following methods: depressing the pilot's disconnect switch; operating the manual trim switch or operating the AP engage lever on the Mode Controller. The AP light on the annunciator panel will flash at least four times and remain off to indicate the AP is disengaged.

- (3) **AP Mode:**  
The AP must be engaged before any other mode can be engaged. The AP mode alone indicates PAH and wings level. The AP will automatically follow any other modes engaged. Disengaging the AP disengages all other modes.

NOTE

THE VERTICAL TRIM SWITCH (LOCATED ON THE KC 292 MODE CONTROLLER PANEL) MAY BE USED TO TRIM THE PITCH ATTITUDE AT A RATE OF ONE DEGREE PER SECOND.

- (4) **Altitude Hold Mode:**  
When the ALT switch on the Mode Controller is pressed the airplane will maintain the pressure altitude existing at the time the switch is depressed. For smooth operation, engage the ALT at no greater than 500 feet per minute climb/descent. The ALT will automatically disengage when Glideslope couples or the GO AROUND switch is depressed. ALT hold may be turned off at any time by depressing the ALT switch. ALT engagement is displayed on the annunciator panel.

NOTE

THE VERTICAL TRIM SWITCH (LOCATED ON THE KC 292 MODE CONTROLLER PANEL) MAY BE USED TO CHANGE OR TRIM THE ALTITUDE UP OR DOWN AT 500 FPM WITHOUT DISENGAGING THE MODE.

- (5) **Heading Mode:**  
Set the heading bug to the desired heading on the PNI, engage the AP, and depress the HDG switch on the Mode Controller. HDG and AP will be displayed on the annunciator panel. The airplane will turn to the heading selected and hold. The pilot may then choose any new heading by merely setting the bug on a new heading. The airplane will automatically turn in the direction the heading bug is turned. To disengage the HDG Mode, depress the HDG switch on the Mode Controller and observe the HDG light go out on the annunciator panel. The HDG Mode will automatically disengage when APPR or NAV CPLD is achieved.
- (6) **NAV Mode:**  
The navigation mode may be selected by tuning the NAV receiver to the desired frequency, setting the CDI to the desired radial and with the AP engaged, depressing the NAV switch on the Mode Controller. If the NAV switch is engaged with a centered needle on the CDI, the mode will go directly to NAV CPLD as displayed on the annunciator panel. If a condition requiring a capture exists at mode engagement, the pilot is required to set up an intercept angle using either HDG or AP mode. NAV may be disengaged by pressing Nav switch or by engaging HDG or APPR when in NAV CPLD.

CAUTION

THE NAV MODE OF OPERATION WILL CONTINUE TO PROVIDE AIRPLANE CONTROL WITHOUT A VALID VOR/LOC SIGNAL (NAV FLAG IN VIEW).

(7) Approach Mode:

To select the approach mode, tune the appropriate VOR or LOC frequency and with the AP engaged, depress the APPR switch on the Mode Controller. The annunciator will indicate APPR ARM until intercepting the course when it will automatically couple and track. The system can intercept at any angle and will always turn toward the course pointer. See approach procedure for more detail. Approach mode can be disengaged by depressing the APPR switch on the Mode Controller, by depressing the GA switch on the left engine throttle control, or by engaging HDG or NAV when in APPR CPLD. The annunciator panel indicates the status of the approach mode.

CAUTION

THE APPR MODE OF OPERATION WILL CONTINUE TO PROVIDE AIRPLANE CONTROL WITHOUT A VALID VOR/LOC SIGNAL (NAV FLAG IN VIEW).

(8) Back Course Mode:

For back Course (BC) operation, proceed as for normal approach mode, but engage BC after selecting APPR. The BC switch reverses the signals in the computer and cannot be engaged without a LOC frequency selected. BC status is indicated on the annunciator panel. BC mode can be disengaged by depressing either the BC, APPR, or GA switches, or by selecting other than a LOC frequency on the Nav receiver.

(9) Trim Up/Dn:

Operation of the vertical trim switch on the Mode Controller provides a convenient means of adjusting the ALT hold or PAH angle function without disengaging the mode.

(10) Go Around Mode (GA):

The GA mode may be engaged any time the AP is engaged by depressing the GA switch on the left engine throttle. GA will illuminate on the annunciator panel indicating mode status, on models with serial numbers 34-8070021 and below the GA mode provides a fixed pitch up angle that will command the best rate of climbout for single engine performance. GA will cancel all other vertical modes as well as APPR or NAV CPLD.

On models with serial numbers 34-8070022 and up, the AP if engaged will disengage. GA will cancel all other vertical modes as well as APPR or NAV CPLD.

(i) VOR PROCEDURES

- (1) Tune NAV receiver to appropriate frequency.
- (2) Set desired Heading with the HDG BUG to intercept radial and engage AP and HDG.
- (3) Select desired radial and engage NAV. The airplane will remain on HDG as indicated on the annunciator panel and ARM on the NAV mode. When the airplane intercepts the beam, the system will automatically couple and track in NAV mode and indicate CPLD on the annunciator panel.
- (4) A new course may be selected over the VOR station when operating in the NAV mode, by selecting a new radial when the To-From indication changes.
- (5) For VOR approach, see approach procedure.

(j) APPROACH PROCEDURES

- (1) Tune ILS or VOR.
- (2) Set CDI for inbound course.

- (3) Set Heading Bug and engage HDG to intercept course beam at any angle.
- (4) Engage APPR and note APPR ARM on the annunciator panel.
- (5) When airplane approaches beam APPR will couple, HDG will decouple, airplane will track LOC or VOR, and CPLD will illuminate on the annunciator panel.
- (6) When the glideslope beam is intercepted, the glideslope (GS) will couple automatically and indicate GS on the annunciator panel. If the ALT MODE was engaged prior to intercepting the glideslope, it will automatically disengage when GS couples. Airplane will now track LOC and GS. Adjust throttles to control speed on descent. Set HDG bug for missed approach but do not engage HDG.

NOTE

Operation of marker test function after APPR CPLD will reduce the flight control system gains. If this should occur, the APPR switch should be recycled.

- (7) Landing or missed approach
  - a. Disengage AP and land.
  - b. Go-Around by depressing the GA switch on left engine throttle, on models with serial numbers 34-8070021 and below. The AP will remain engaged and will command a climb. APPR Mode may be used for a straight away missed approach or HDG may be engaged to turn to the missed approach heading.

On models with serial numbers 34-8070022 and up, the AP if engaged will disengage GA will cancel all other vertical modes as well as APPR or NAV CPLD.

(k) BACK COURSE PROCEDURE

Same as front course except that BC is engaged after APPR is engaged and the airplane must be set for descent manually by holding the vertical trim control DN on the Mode Controller or by establishing the desired PAH angle using the CWS.

SECTION 5 - PERFORMANCE

Installation of the King KFC 200 Flight Control System does not effect the basic performance information presented by Section 5 of this handbook.

**THIS PAGE INTENTIONALLY LEFT BLANK**

**SUPPLEMENT 8**

**KNS 80 NAVIGATION SYSTEM**

**SECTION 1 - GENERAL**

This supplement supplies information necessary for the operation of the airplane when the optional KNS 80 Navigation System is installed. The information contained within this supplement is to be used in conjunction with the complete handbook.

This supplement has been "FAA Approved" as a permanent part of this handbook and must remain in this handbook at all times when the optional KNS 80 Navigation System is installed.

**SECTION 2 - LIMITATIONS**

No changes to the basic limitations provided by Section 2 of this Pilot's Operating Handbook are necessary for this supplement.

**SECTION 3 - EMERGENCY PROCEDURES**

No changes to basic Emergency Procedures provided by Section 3 of this Pilot's Operating Handbook are necessary for this supplement.

**SECTION 4 - NORMAL PROCEDURES**

(a) **KNS 80 OPERATION**

The KNS 80 can be operated in any one of 3 basic modes: (a) VOR, (b) RNAV, or (c) ILS. To change for one mode to another, the appropriate pushbutton switch is pressed, except that the ILS mode is entered automatically whenever an ILS frequency is channeled in the USE waypoint. The display will annunciate the mode by lighting a message above the pushbutton. In addition to the standard VOR and RNAV enroute (RNV ENR) modes, the KNS 80 has a constant course width or parallel VOR mode (VOR PAR) and a RNAV approach mode (RNV APR). To place the unit in either of these secondary modes the VOR pushbutton or the RNAV pushbutton, as the case may be, is pushed a second time. Repetitive pushing of the VOR button will cause the system to alternate between the VOR and VOR PAR modes, while repetitive pushing of the RNAV button causes the system to alternate between RNV ENR and RNV APR modes.

- (b) **CONTROLS**
- (1) **VOR BUTTON**  
Momentary pushbutton.  
When pushed while system is in either RNV mode causes system to go to VOR mode. Otherwise the button causes system to toggle between VOR and VOR PAR modes.
  - (2) **RNAV BUTTON**  
Momentary pushbutton.  
When pushed while system is in either VOR mode causes system to go to RNV ENR mode. Otherwise the button causes system to toggle between RNV ENR and RNV APR modes.
  - (3) **HOLD BUTTON**  
Two position pushbutton.  
When in depressed position, inhibits DME from channeling to a new station when the VOR frequency is changed. Pushing the button again releases the button and channels the DME to the station paired with the VOR station.
  - (4) **USE BUTTON**  
Momentary pushbutton.  
Causes active waypoint to take on same value as displayed waypoint and data display to go to FRQ mode.
  - (5) **DSP BUTTON**  
Momentary pushbutton.  
Causes displayed waypoint to increment by 1 and data display to go to frequency mode.
  - (6) **DATA BUTTON**  
Momentary pushbutton.  
Causes waypoint data display to change from FRQ to RAD to DST and back to FRQ.
  - (7) **OFF/PULL ID CONTROL**
    - a. Rotate counterclockwise to switch off power to the KNS 80.
    - b. Rotate clockwise to increase audio level.
    - c. Pull switch out to hear VOR Ident.
  - (8) **DATA INPUT CONTROL**  
Dual concentric knobs. Center knob has "in" and "out" positions.
    - a. **Frequency Data**  
Outer knob varies 1 MHz digit.  
A carryover occurs from the units to tens position.  
Rollover occurs from 117 to 108 or vice versa.  
Center knob varies frequency in .05 MHz steps regardless of whether the switch is in its "in" or "out" position.
    - b. **Radial Data**  
Outer knob varies 10 degree digit.  
A carryover occurs from tens to hundreds position.  
A rollover to zero occurs at 360 degrees.  
Center knob "in" position varies 1 degree digit.  
Center knob "out" position varies 0.1 degree digit.



**c. Distance Data**

Outer knob varies 10 NM digit.

A carryover occurs from the tens to hundreds place.

A rollover to zero occurs at 200 NM.

Center knob "in" position varies 1 NM digit.

Center knob "out" position varies 0.1 NM digit.

**(9) COURSE SELECT KNOB**

Located in CDI unit.

Selects desired course through the VOR ground station or waypoint.

**SECTION 5 - PERFORMANCE**

No changes to the basic performance provided by Section 5 of this Pilot's Operating Handbook are necessary for this supplement.

THIS PAGE INTENTIONALLY LEFT BLANK

SUPPLEMENT 9

ANS 351 AREA NAVIGATION COMPUTER

SECTION 1 - GENERAL

This supplement supplies information necessary for the operation of the airplane when the optional ANS 351 Area Navigation Computer is installed. The information contained within this supplement is to be used in conjunction with the complete handbook.

This supplement has been "FAA Approved" as a permanent part of this handbook and must remain in this handbook at all times when the optional ANS 351 Area Navigation Computer is installed.

SECTION 2 - LIMITATIONS

No changes to the basic limitations provided by Section 2 of this Pilot's Operating Handbook are necessary for this supplement.

SECTION 3 - EMERGENCY PROCEDURES

No changes to basic Emergency Procedures provided by Section 3 of this Pilot's Operating Handbook are necessary for this supplement.

SECTION 4 - NORMAL PROCEDURES

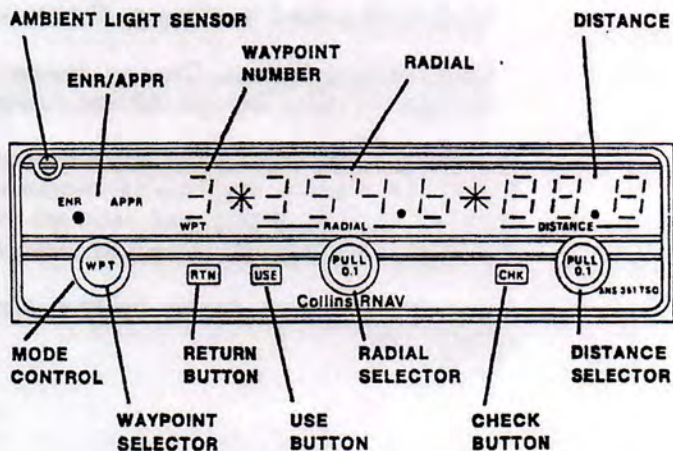

ANS 351 AREA NAVIGATION COMPUTER, CONTROLS AND INDICATORS

(a) CONTROLS

CONTROL OR INDICATOR	FUNCTION
Mode Control	Selects ENR (enroute) or APPR (approach) modes of operation. In the enroute mode, CDI deviation is 1 mile/dot, 5 miles full scale. In approach, CDI deflection is 1/4 mile/dot, 1-1/4 miles full scale.
Waypoint Selector	Sequences display waypoints from 1 through 8. Winking waypoint number indicates inactive waypoints; steadily-on-waypoint number indicates active waypoint.
Return Button	Depressing RTN (return) button returns the display to the active waypoint when an inactive waypoint is currently being displayed.
Use Button	Depressing the USE button converts the waypoint being displayed into the active waypoint.
Radial Selector	Two concentric knobs set radial information into the display. Knobs control information as follows: Large knob: Changes display in 10-degree increments. Small knob pushed in: Changes display 1-degree increments. Small knob pulled out: Changes display in 0.1-degree increments.
Distance Selector	Two concentric knobs set distance information in nautical miles into the display. Knobs control information as follows: Large knob: Changes display in 10-mile increments. Small knob pushed in: Changes display 1-mile increments. Small knob pulled out: Changes display in 0.1-mile divisions from 00.0 through 100 miles. Beyond 100 nmi, changes display in 1-mile increments.
Check Button	Depressing CHK (check) button causes DME and bearing indicators to display raw distance and bearing information. RNAV computation. CDI deviation, to/from display, and autopilot tracking of RNAV path remain unaffected. The check button is spring-loaded to prevent permanent actuation.
Ambient Light Sensor	Automatically adjusts display lighting intensity as a function of cockpit ambient light.

(b) AREA NAVIGATION WAYPOINT PROGRAMMING

(1) Presetting of Waypoint On Ground

Waypoints are entered after engine start, since the waypoint information will probably be lost during the low-voltage condition occurring during engine cranking. Waypoint data should always be written in flight planning form to facilitate checking later in flight. When power is first applied to the ANS 351 and the system is in the RNAV mode, waypoint number 1 will be active, (waypoint number not blinking) and waypoint bearing and distance preset to zero will appear.

- a. Waypoint number 1 coordinates are set into the ANS 351 using concentric knobs under bearing and distance display fields.
- b. The waypoint selection knob is then rotated to select waypoint number 2. Note that the waypoint number is blinking, indicating that the waypoint is at this point inactive. Waypoint number 2 bearing and distance definitions are then set into the ANS 351.
- c. Set up the rest of the desired waypoints as described above.
- d. Press the RTN (return) pushbutton to display the active waypoint.

(2) Changing Waypoints In Flight

To change a waypoint in flight, rotate the waypoint selector until the desired waypoint number and coordinates are displayed on the ANS 351.

- a. Verify that the waypoint definition is correct by comparing the display with the flight plan.
- b. Uncouple the autopilot if tracking RNAV deviation.
- c. Select the desired reference facility frequency on the associated NAV receiver.
- d. Depress the USE pushbutton and note that the waypoint identification number stops winking.
- e. Select the desired course on OBS.
- f. Recouple the autopilot after deviation and distance-to-waypoint indications have stabilized.

**SECTION 5 - PERFORMANCE**

No changes to the basic performance provided by Section 5 of this Pilot's Operating Handbook are necessary for this supplement.

THIS PAGE INTENTIONALLY LEFT BLANK

**SUPPLEMENT 10**

**NP-2041A AREA NAVIGATION COMPUTER PROGRAMMER**

**SECTION 1 - GENERAL**

This supplement supplies information necessary for the operation of the airplane when the optional NP-2041A Area Navigation Computer Programmer is installed. The information contained within this supplement is to be used in conjunction with the complete handbook.

This supplement has been "FAA Approved" as a permanent part of this handbook and must remain in this handbook at all times when the optional NP-2041A Area Navigation Computer Programmer is installed.

**SECTION 2 - LIMITATIONS**

No changes to the basic limitations provided by Section 2 of this Pilot's Operating Handbook are necessary for this supplement.

**SECTION 3 - EMERGENCY PROCEDURES**

No changes to basic Emergency Procedures by Section 3 of this Pilot's Operating Handbook are necessary for this supplement.

**SECTION 4 - NORMAL PROCEDURES**

**NOTE**

The #1 VOR and DME receivers supply information to the NAV computer programmer, which in turn drives the pilot's navigation displays.

- (a) Turn the VHF COM/NAV on and set the DME frequency pairing selector to N1.
- (b) Turn the DME on.
- (c) **FREQUENCY SELECTION**
  - (1) **MANUAL** - Set KBD/NAV 1/COM 1 selector on COM/NAV to NAV 1. Set in frequency of the reference VOR/DME station.
  - (2) **KEYBOARD** - Set KBD/NAV 1/COM 1 selector on COM/NAV to KBD. Set in the frequency of VOR/DME station from the keyboard on the NP-2041A.

- (d) Set the mode selector on the NP-2041A to VOR/LOC.
- (e) Set the display selector on the NP-2041A to SBY.
- (f) Address Standby Waypoint 1 by pressing the SBY WPT key and the #1 key.
- (g) Program Waypoint 1 parameters (any sequence).

**NOTE**

Pressing the **FREQ**, **BRG**, **DST**, **EL**, or **CRS** keys causes flashing dot to appear in the associated display window. A flashing dot indicates the parameter that is being addressed. As number keys corresponding to data are pressed, the numbers appear in the addressed window. If valid data is entered into the window, the flashing dot will extinguish when the **ENTER** key is pressed. If invalid data is entered in the window, the data will be rejected when the **ENTER** key is pressed and the window will revert to a flashing dot, which indicates data should be re-entered.

- (1) **STATION FREQUENCY** - Press **FREQ** key; press number keys corresponding to the frequency of the VOR station; and press the **ENTER** key.
- (2) **WAYPOINT BEARING** - Press **BRG** key; press number keys corresponding to the waypoint bearing; and press the **ENTER** key.
- (3) **WAYPOINT DISTANCE** - Press **DIST** key; press number keys corresponding to the waypoint distance; and press the **ENTER** key.
- (4) **STATION ELEVATION** - Press **EL** key; press number keys corresponding to the station elevation in hundreds of feet; and press the **ENTER** key.
- (5) **INBOUND AND OUTBOUND COURSE** - Press **CRS** key; press number keys corresponding to the desired inbound or outbound course (depending upon whether **IN** or **OUT** annunciator lamp is illuminated); and press the **ENTER** key.

Press **CRS XFR** key; **IN/OUT** annunciator lamps will switch. Press **CRS** key, press number keys corresponding to the desired inbound or outbound course (as annunciated); and press the **ENTER** key.

- (h) Repeat Step (f) and (g) for any (or all) of the remaining waypoints.
- (i) Press **SBY WPT** key; press number key corresponding to the waypoint desired to be recalled from memory; and verify data.
- (j) Set the display selector to **BRG/DST**.



- (k) Press the WPT XFR key to transfer the standby waypoint to active.

**NOTE**

Provided the KBD/NAV 1/COM 1 selector on the COM/NAV unit is set to KBD, the NAV receiver and DME will be automatically tuned to the frequency stored for the active waypoint. The stored inbound course will be displayed in the CRS window for 30 seconds to allow the CRS control (OBS) on the IN-831 HSI to be set to that course. After the waypoint has been passed, the CRS XFR key can be pressed to recall the outbound course which will appear for 30 seconds to allow the CRS to be reset.

The course pointer on the IN-881 HSI will automatically reset to the display course, provided its function switch is in the HSI position.

- (l) With the mode selector set to VOR/LOC, the following data is displayed.
- (1) DISPLAY SELECTOR SET TO BRG/DST - Bearing and distance to the selected VOR/DME station are displayed.
  - (2) DISPLAY SELECTOR SET TO KTS/TTS - Ground speed in knots and time-to-station are displayed in minutes.
  - (3) HSI - The HSI presents unprocessed information with conventional angular sensitivity, i.e., full scale deviation equals 10° off course.
  - (4) DISPLAY SELECTOR SET TO SBY - Data stored for standby waypoint (number appearing in SBY window) is displayed, and can be altered as desired.
  - (5) DISPLAY SELECTOR SET TO ACT - Data stored for active waypoint (number in ACT display window) is displayed, but cannot be altered.
- (m) With the mode selector set to RNAV, the following data is displayed.
- (1) DISPLAY SELECTOR SET TO BRG/DST - Bearing and distance to the selected waypoint is displayed.
  - (2) DISPLAY SELECTOR SET TO KTS/TTS - Ground speed in knots and time-to-waypoint is displayed in minutes.
  - (3) HSI - The HSI presents RNAV information with constant deviation, i. e., full scale deviation represents 5 nautical miles off course out to a distance of 100 nautical miles. From thereon full scale deviation represents 3° off course.
  - (4) DISPLAY SELECTOR SET TO SBY - Data stored for standby waypoint (number appearing in SBY window) is displayed and can be altered as desired.
  - (5) DISPLAY SELECTOR SET TO ACT - Data stored for active waypoint (number appearing in ACT window) is displayed, but cannot be altered.

- (n) With the mode selector set to APR, the displays are the same as RNAV, except full scale deviation represents 1.25 nautical miles off course out to 25 nautical miles. From thereon, full scale deviation represents 3° off course.
- (o) Program COM and NAV frequencies by performing the following steps.

**NOTE**

To program the COM/NAV Unit from the NP-2041A keyboard, the KBD/NAV/COM selector switches must be set to KBD.

- (1) **MODE SELECTOR** - The mode selector on the NP-2041A can be on in any position other than OFF or TEST to program COM 1 or COM 2 frequencies.
- (2) **COM 1 FREQUENCY** - Press COM 1 key; press number keys corresponding to the desired frequency; and press the ENTER key.
- (3) **COM 2 FREQUENCY** - Press COM 2 key; press number keys corresponding to the desired frequency; and press the ENTER key.
- (4) **NAV 1 FREQUENCY** - Set the mode selector to VOR/LOC. (To tune NAV 1 from keyboard, mode selector must be set to VOR/LOC.) Press NAV 1 key; press number keys corresponding to the desired frequency; and press the ENTER key.
- (5) **NAV 2 FREQUENCY** - Press NAV 2 key; press number keys corresponding to the desired frequency; and press the ENTER key.

**SECTION 5 - PERFORMANCE**

No changes to the basic performance provided by Section 5 of the Pilot's Operating Handbook are necessary for this supplement.

**SUPPLEMENT 11**

**RDR-160 WEATHER RADAR SYSTEM**

**SECTION 1 - GENERAL**

This supplement supplies information necessary for the operation of the airplane when the optional RDR-160 Weather Radar System is installed. The information contained within this supplement is to be used in conjunction with the complete handbook.

This supplement has been "FAA Approved" as a permanent part of this handbook and must remain in this handbook at all times when the optional RDR-160 Weather Radar System is installed.

**SECTION 2 - LIMITATION**

No changes to the basic limitations provided by Section 2 of this Pilot's Operating Handbook are necessary for this supplement.

**SECTION 3 - EMERGENCY PROCEDURES**

No changes to basic Emergency Procedures by Section 3 of this Pilot's Operating Handbook are necessary for this supplement.

**SECTION 4 - NORMAL PROCEDURES**

(a) System Controls

Table 4-3 lists and describes the system controls, all of which are mounted on the panel of the radar indicator. Figure 4-1 illustrates the location of these controls. Table 4-5 lists the alphanumeric readouts of range - range marks and mode selection as a function of switch position.

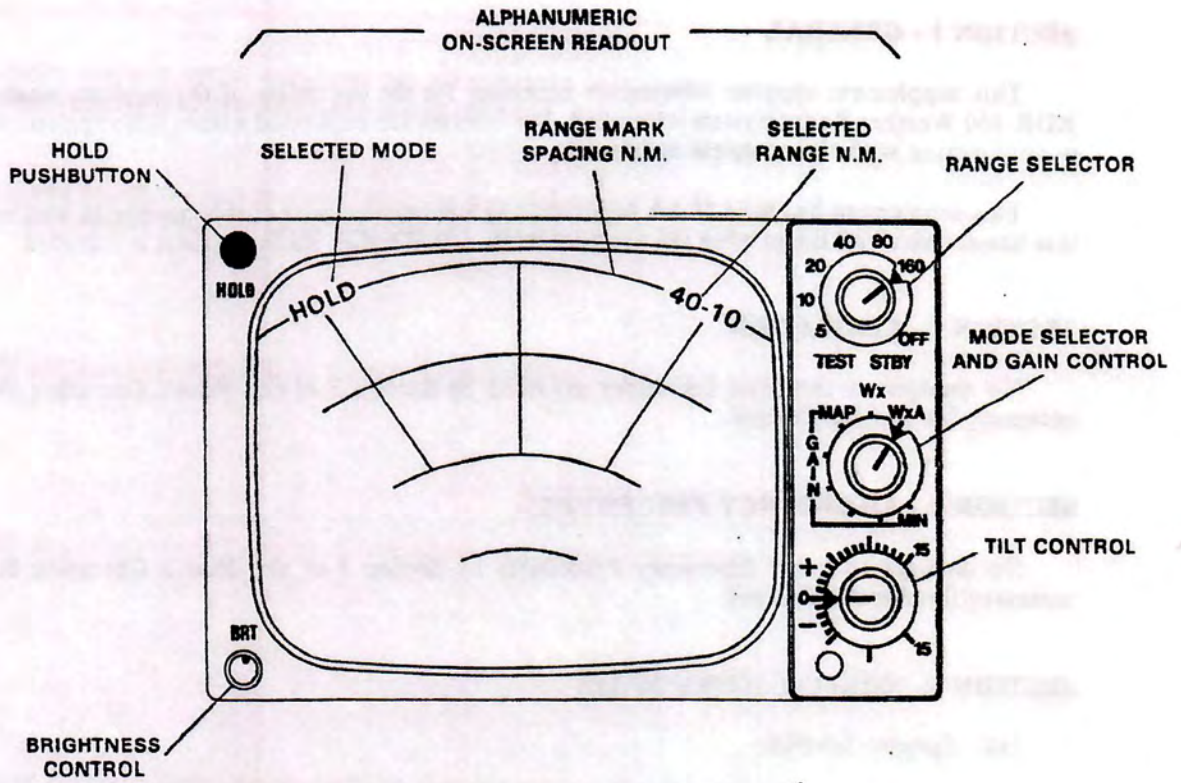

LOCATION OF CONTROLS  
Figure 4-1

CONTROL	FUNCTION	OPERATIONAL USE
OFF/STBY/TEST	Range selector	<ol style="list-style-type: none"> <li>1) Controls primary power to radar system.</li> <li>2) Places system in "standby" condition during warmup period and when system is not in use.</li> <li>3) Places system in "test" mode to determine operability of system. No transmission in "test" mode.</li> <li>4) Selects operating range. Enables transmitter.</li> </ol>
Wx/GAIN/Wx A	Gain control and Mode Selector	<ol style="list-style-type: none"> <li>1) In Wx position, weather image gain is at pre-adjusted level. Contour operation is automatic and constant.</li> <li>2) In GAIN position, 6 levels from MAP (maximum gain) to MIN may be selected for ground mapping operations. Contour operation is disabled.</li> <li>3) In Wx A position, the radar indicator display alternately cycles between the Wx position and the GAIN MAP position. This will verify if a contour storm cell area is a storm cell and not a lake or some other terrain feature.</li> </ol>
HOLD Pushbutton	Video Hold/ Scan	<p>When the HOLD pushbutton initially depressed, weather or ground mapping image last presented is retained (frozen) on indicator display in order to evaluate the significance of storm cell movement. Depressing for a second time reveals direction and distance of target movement during hold period. During HOLD mode, the antenna continues to scan and the display will continue to be presented as long as power is supplied to the system. The word HOLD will be flashing.</p>
TILT	Antenna tilt control	Electrically adjusts the antenna to move the radar beam to 15 degrees up or down from horizontal ("0" position).
BRT	Brightness Control	Control CRT picture insensity.

Table 4-3

**RADAR-160 WEATHER RADAR SYSTEM**

Range Switch Position	Range-Range Mark Readout
**TEST	40-10
5	5-1
10	10-2
20	20-4
40	40-10
80	80-20
160	160-40
Wx-MAP-Wx A Switch Position	Mode Readout*
Wx	Wx
MAP	MAP
WxA	WxA

\*When the HOLD pushbutton is initially depressed, the MODE READOUT displays flashing HOLD.  
\*\*The MODE READOUT displays TEST.

Alphanumeric Readout  
Table 4-5

(b) General Operating Precautions

**WARNING**

DO NOT OPERATE THE RADAR DURING REFUELING OPERATIONS OR IN THE VICINITY OF TRUCKS OF CONTAINERS ACCOMMODATING FLAMMABLES OR EXPLOSIVES; DO NOT ALLOW PERSONNEL WITHIN 15 FEET OF AREA BEING SCANNED BY ANTENNA WHEN SYSTEM IS TRANSMITTING.

- (1) Flash bulbs can be exploded by radar energy.
- (2) Since storm patterns are never stationary, the display is constantly changing, and continued observation is always advisable where areas of turbulence prevail.

**NOTE**

See RDR-160 pilot manual for detailed operating information and analysis of targets.

**SECTION 5 - PERFORMANCE**

No changes to the basic performance provided by Section 5 of the Pilot's Operating Handbook are necessary for this supplement.

**SUPPLEMENT 12**

**RDR-160/IN2026A WEATHER RADAR SYSTEM**

**SECTION 1 - GENERAL**

This supplement supplies information necessary for the operation of the airplane when the optional RDR-160/IN2026A Weather Radar System is installed. The information contained within this supplement is to be used in conjunction with the complete handbook.

This supplement has been "FAA Approved" as a permanent part of this handbook and must remain in this handbook at all times when the optional RDR-160/IN2026A Weather Radar System is installed.

**SECTION 2 - LIMITATIONS**

No changes to the basic limitations provided by Section 2 of this Pilot's Operating Handbook are necessary for this supplement.

**SECTION - 3 EMERGENCY PROCEDURES**

No changes to the basic Emergency Procedures by Section 3 of this Pilot's Operating Handbook are necessary for this supplement.

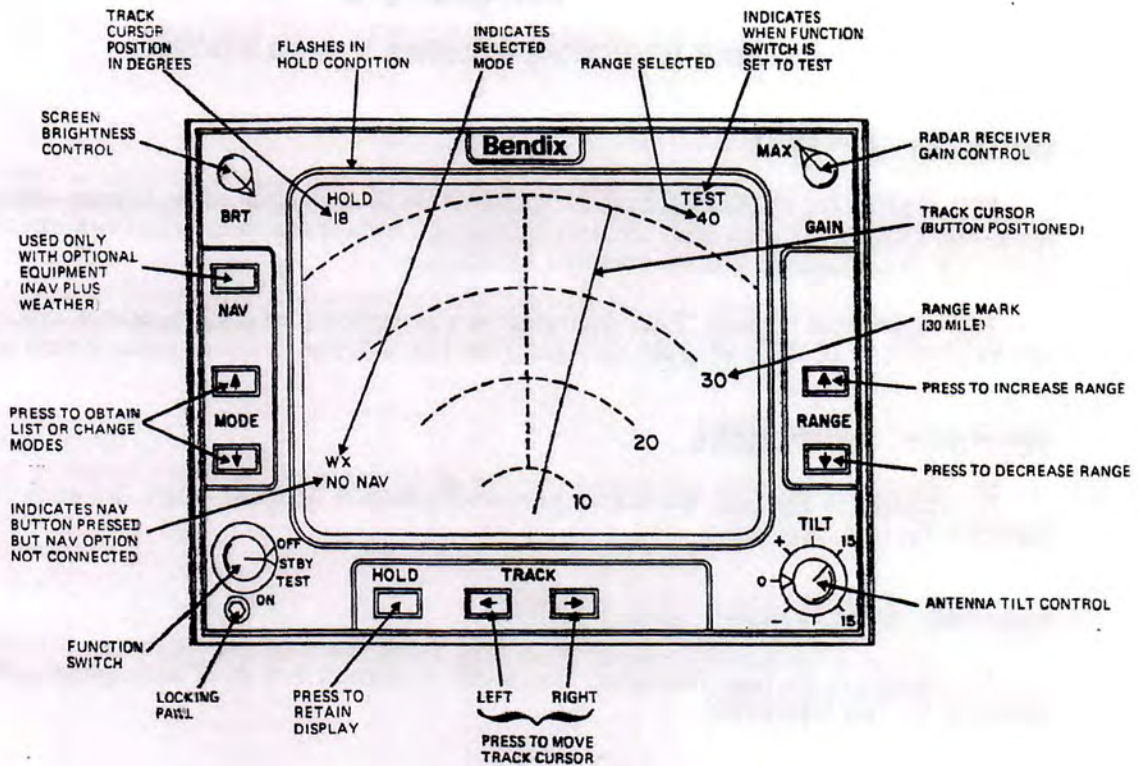

IN-2026A CONTROLS AND DISPLAYS  
Figure 4-1

(a) Equipment Operation and Controls

(1) RDR-160/IN-2026A Controls and Displays

Controls and displays for the RDR-160/IN-2026A Weather Radar System are listed in table 4-3, with a functional description. Location of the controls and displays is shown in figure 4-1. All operating controls and displays are located on the indicator.



CONTROL/DISPLAY	FUNCTION
Function selector	<ol style="list-style-type: none"> <li>1. OFF position removes primary power from the system.</li> <li>2. STBY position places system in the standby condition during warm-up period and when the system is not in use. No display.</li> <li>3. TEST position selects test function to determine operability of the system. A test pattern is displayed. NO transmission exists in the TEST condition.</li> <li>4. ON position selects the condition for normal operation. Radar transmission exists in the ON position.</li> </ol>
[ ↓ ] RANGE button	Clears the display and places the indicator in the next lower range each time the button is pressed (eg: 40 to 20), until minimum range is reached.
TILT control	Electrically adjusts the antenna to move the radar beam up to +15 degrees above the horizontal, or to a maximum of -15 degrees below the horizontal position. The horizontal position is indicated as zero degrees on the control.
TRACK [→] button	When pressed, a yellow track cursor line appears and moves to the right (in one degree steps) while the button is held depressed. The track cursor stops when the button is released, and remains for about 10 to 15 seconds, then disappears unless the button is pressed again. The differential heading will be indicated in yellow numerals in the upper left corner of the display, and disappears simultaneously with the track cursor.
TRACK [←] button	When pressed, the yellow track cursor appears and moves to the left while held depressed. Operation is as explained above.
GAIN control	Varies the radar receiver gain when in the MAP mode. Gain and the STC are preset in TEST function and in the WX and WXA modes.
BRT control	Adjusts brightness of the display for varying cockpit light conditions.
[ ↑ ] MODE button	<p>Pressing momentarily produces an "information list" on the display. Pressing again, while information display is still present, advances the indicator display to the next higher mode shown on the list. The list disappears after a few seconds and the mode does not change if the button is not pressed again. The following standard modes are available in the order shown.</p> <p>NAV FLT LOG - Functions available with optional IU-2023A.            MAP - Ground mapping            WXA - Weather mapping with alert. The red area flashes.            WX - Weather mapping</p> <p>NOTE: When the top mode is reached, the button will not change the mode.</p>

Table 4-3

CONTROL/DISPLAY	FUNCTION
[ ↓ ] MODE button	<p>Moves the indicator display to the next lower mode each time the button is pressed while the list is present. The sequence is as listed above.</p> <p>NOTE: When the bottom mode (WX) is reached, this button will not change the mode.</p>
NAV button (push-on/push-off)	<p>Operational only when optional IU-2023A Remote Computer Unit is connected. When actuated, provides NAV information superimposed over the MODE selected (WX, WXA, or MAP). If interface is not connected, the words NO NAV will be displayed in the lower left corner.</p>
[ ↑ ] RANGE button	<p>Clears the display and advances the indicator to the next higher range each time the button is pressed (eg: 20 to 40, 40 to 80, etc.), until 160 mile range is reached. The range selected is displayed in the upper right corner (on the last range mark), and the distance to each of the other range marks circles is displayed along the right edge of the circles (arcs).</p>
HOLD pushbutton (push-on/push-off)	<p>Retains the display (NAV and weather) when button is actuated (push-on). The word HOLD flashes in the upper left corner of the display. The weather or ground mapping image last presented is retained (frozen) on indicator display in order to evaluate the significance of storm cell movement. Switching back to normal operation (pressing HOLD pushbutton a second time) reveals direction and distance of target movement during HOLD period. In HOLD, the antenna continues to scan and a non-updated display will continue to be presented as long as power is supplied to the system. A change in range selection, with indicator in HOLD results in a blank screen.</p>

Table 4-3 (Cont.)

(b) Operating Precautions

**WARNING**

**DO NOT OPERATE THE RADAR DURING REFUELING OPERATIONS OR IN THE VICINITY OF TRUCKS OR CONTAINERS ACCOMMODATING FLAMMABLES OR EXPLOSIVES. DO NOT ALLOW PERSONNEL WITHIN 15 FEET OF AREA BEING SCANNED BY ANTENNA WHEN SYSTEM IS TRANSMITTING.**

- (1) Flash bulbs can be exploded by radar energy.
- (2) Since storm patterns are never stationary, the display is constantly changing. Continued observation is always advisable in stormy areas.

**SECTION 5 - PERFORMANCE**

No changes to the basic performance provided by Section 5 of the Pilot's Operating Handbook are necessary for this supplement.

**SUPPLEMENT 13**

**PIPER CONTROL WHEEL CLOCK INSTALLATION**

**SECTION 1 - GENERAL**

This supplement supplies information necessary for the operation of the airplane when the optional Piper control wheel clock is installed. The information contained within this supplement is to be used in conjunction with the complete handbook.

This supplement has been "FAA Approved" as a permanent part of this handbook and must remain in this handbook at all times when the optional Piper control wheel clock is installed.

**SECTION 2 - LIMITATIONS**

No changes of the basic limitations provided by Section 2 of this Pilot's Operating Handbook are necessary for this supplement.

**SECTION 3 - EMERGENCY PROCEDURES**

No changes of the basic Emergency Procedures provided by Section 3 of this Pilot's Operating Handbook are necessary for this supplement.

**SECTION 4 - NORMAL PROCEDURES**

(a) **SETTING**

While in the **CLOCK** mode, the time and the date can be set by the operation of the **RST** button.

(b) **DATE SETTING**

Pressing the **RST** button once will cause the **date** to appear with the **month** flashing. Pressing the **ST-SP** button will advance the month at one per second, or at one per push, until the right month appears.

Pressing the **RST** button once again will cause the date to flash, and it can be set in a similar manner.

**(c) TIME SETTING**

The RST button must now be pressed two times to cause the hours digits to flash. The correct hour can be set in as described above

Pressing the RST button once again will now cause the minutes digits to flash. The minutes should be set to the next minute to come up at the zero seconds time mark. The RST button is pressed once more to hold the time displayed. At the time mark, the ST-SP button is pressed momentarily to begin the counting at the exact second.

If the minutes are not advanced when they are flashing in the set mode, pressing the RST button will return the clock to the normal timekeeping mode without altering the minutes timing. This feature is useful when changing time zones, when only the hours are to be changed.

**(d) AUTOMATIC DATE ADVANCE**

The calendar function will automatically advance the date correctly according to the four year perpetual calendar. One day must be added manually on Feb. 29 on leap year. The date advances correctly at midnight each day.

**(e) DISPLAY TEST**

Pressing both the RST and ST-SP buttons at the same time will result in a display test function.

**SECTION 5 - PERFORMANCE**

No changes to the basic performance provided by Section 5 of this Pilot's Operating Handbook are necessary for this supplement.

SUPPLEMENT 14

FOR

RCA WEATHER SCOUT II MONOCHROME WEATHER RADAR

SECTION 1 - GENERAL

This supplement must be attached to the Pilot's Operating Handbook and FAA Approved Airplane Flight Manual when the RCA Weather Scout II Monochrome Weather Radar is installed. The information contained herein supplements or supersedes the basic Pilot's Operating Handbook and FAA Approved Airplane Flight Manual only in those areas listed herein. For limitations, procedures and performance information not contained in this supplement, consult the basic Pilot's Operating Handbook and FAA Approved Airplane Flight Manual.

DESCRIPTION

The Weather Scout System is an alphanumeric digital weather radar system which detects storms along the flightpath and gives the pilot a 4 level visual display of their intensity. Areas of heaviest rainfall (level 3) will be brightest; areas of less severe and moderate rainfall (levels 2 and 1) will be progressively less bright; and no rainfall (level 0) will be black. The radar system performs only the function of weather detection and should not be used, nor relied upon, for proximity warning or anti-collision protection.

The system consists of two units; a Receiver-Transmitter Antenna (RTA) and a Digital Indicator (DI). The DI is mounted in the cockpit and contains all the controls used to operate the radar. For 28-VDC operation, the DI contains a DC-DC converter so that the actual power used in the system is always 14 volts. Range and mode alphanumeric and a test-bar pattern are always displayed on the 5 inch rectangular cathode-ray tube to facilitate evaluation of the weather display.

OPERATING CONTROLS AND DISPLAY FEATURES

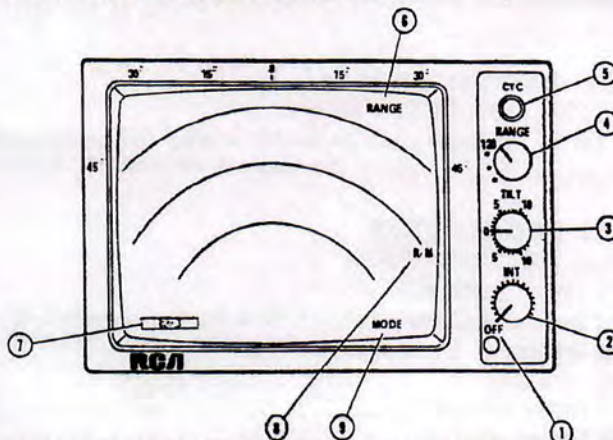

INDICATOR CONTROLS AND DISPLAY FEATURES

All controls used to operate the radar system are located on the Digital Indicator front panel.

- 1 OFF                      On/Off function: full CCW rotation of INTensity control places system in OFF condition.
- 2 INT                      Rotary control used to regulate brightness (INTensity) of display.
- 3 TILT                     Rotary control used to adjust antenna elevation position. Control indexes increments of tilt from 0 to 12 degrees up or down.
- 4. RANGE                 Rotary switch used to select one of four ranges.  
    12/30/60/90  
    or  
    12/30/60/120
- 5 CYC                     Pushbutton switch used to select cyclical contour mode. Level-3 data flashes on and off at 0.5 second intervals to highlight the most intense area of rainfall. Pressing switch second time restores normal or WX mode.
- 6 Range Field            Maximum selected range is displayed. Maximum range is always displayed when Indicator is in ON condition.
- 7 Test Field             Test block displays three illuminated levels.
- 8 Range Mark  
  Identifier               Individual label displayed for each range mark.
- 9 Mode                    Operating mode is displayed as CYC. When system is first turned on, WAIT is displayed until system times out (30-40 seconds).

**SECTION 2 - LIMITATIONS**

- (a) Do not operate radar within 15 feet of ground personnel or when refueling operations are within 100 feet of the aircraft.

**SECTION 3 - EMERGENCY PROCEDURES**

There are no changes to the emergency procedures with this equipment installed.

**SECTION 4 - NORMAL PROCEDURES**

- (a) Preliminary Control Settings
  - (1) Place the Indicator Control in the following positions before applying power from the aircraft electrical system:
    - a. INTensity control ..... Full counterclockwise, in OFF
    - b. TILT control ..... Fully upward
    - c. RANGE switch ..... 12 nautical miles

**NOTE**

Control settings in this position will produce minimum hazards to ground personnel should the radar be activated.

**(b) Operational Control Settings**

- (1) Rotate INTensity control clockwise to bring system into ON condition.
- (2) Note that WAIT is displayed during warm-up period of 30-40 seconds.
- (3) When WX is displayed, rotate INTensity control clockwise until display brightness is at desired level.
- (4) Set RANGE switch to desired range.
- (5) Adjust TILT control for desired forward scan area.

**CAUTION**

If the radar is to be operated while the aircraft is on the ground.

- a. Direct nose of aircraft such that antenna scan sector is free of large metallic objects (hangars, other aircraft) for a distance of 100 feet (30 meters), and tilt antenna fully upward.
- b. Avoid operation during refueling of aircraft or during refueling operations within 100 feet (30 meters).
- c. Prevent personnel from standing within 15 feet from the radiating antenna.

**SECTION 5 - PERFORMANCE**

Installation of the RCA Weather Scout II Monochrome Weather Radar does not affect the basic performance information presented in Section 5 of this handbook.

**THIS PAGE INTENTIONALLY LEFT BLANK**



**SUPPLEMENT 15  
FOR  
RCA WEATHER SCOUT II COLOR WEATHER RADAR**

**SECTION 1 - GENERAL**

This supplement must be attached to the Pilot's Operating Handbook and FAA Approved Airplane Flight Manual when the RCA Weather Scout II Color Weather Radar is installed. The information contained herein supplements or supersedes the basic Pilot's Operating Handbook and FAA Approved Airplane Flight Manual only in those areas listed herein. For limitations, procedures and performance information not contained in this supplement, consult the basic Pilot's Operating Handbook and FAA Approved Airplane Flight Manual.

**DESCRIPTION**

The Weather Scout System is an alphanumeric digital display radar used for weather location and analysis. The system detects storms along the flight path and gives the pilot a visual indication of storm intensity. Target returns are displayed at one of four video levels: 0, 1, 2, or 3. Level 0 is shown as a dark screen because of weak or no returns; levels 1, 2, and 3 are shown as green, yellow, and red displays which represents increasing rainfall, from least to heaviest.

The system consists of three units; a Receiver-Transmitter-Antenna, a Digital Indicator, and a Weather Scout Interface Unit.

- (a) **Receiver - Transmitter-Antenna (RTA)**  
The major assemblies contained in the RTA are the Modulator, IF/AFC Programmer, Antenna Drive, Magnetron, Mixer, Local Oscillator, and Parabolic Antenna.
- (b) **Digital Indicator.**  
The Digital Indicator is installed in the aircraft instrument panel. All of the pilot's operating controls are mounted on the front panel of the Digital Indicator. A rectangular 5 inch TV-type cathode ray tube is used for clear viewing. Range/mode alphanumeric are displayed on the screen to facilitate evaluation of displays.
- (c) **Interface Unit**  
The unit provides signal interface functions between the RTA and Digital Indicator and power interface between the aircraft primary supply and the Weather Scout Weather Radar System.

(d) Operating Controls and Display Features

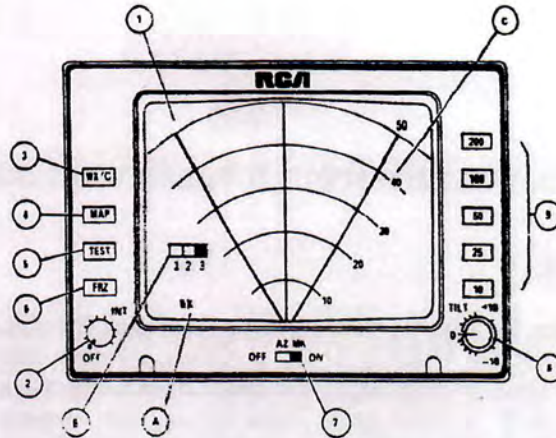

**INDICATOR CONTROLS AND DISPLAY FEATURES**

- (1) Display Area      See item A, B, and C for explanation of alphanumeric display.
- (A) Mode Field      Selected mode is displayed as WX, CYC, MAP, or TEST. STBY is displayed if R-T is warming up and no mode is selected after turn on. WAIT is displayed if a mode is selected prior to end of warm-up or when Indicator and Antenna are synchronizing.
- (B) Auxiliary Field      FRZ is displayed as a blinking word if radar is in freeze mode (to remind pilot that radar display is not being updated for incoming target returns).
- 1, 2, 3, and color bar legend is displayed in WX/C, TEST and MAP modes. In weather mode color bar is green, yellow, and red. In map mode, color bar is cyan, yellow, and magenta.
- (C) Range Mark Identifier      Five labelled range marks are displayed on each range. Label of furthest mark is same as range selected. Range and azimuth marks are displayed in cyan for WX/C and TEST, green for MAP.
- (2) INT/OFF      Rotary control used to regulate brightness (intensity) of display.
- On/Off function: Full CCW rotation of intensity control places system in OFF condition. CW rotation from OFF setting turns system ON. STBY is displayed until WX/C, MAP, or TEST is selected.
- If WX/C or MAP is selected initially or prior to the end of the warm-up period, WAIT will be displayed until RT warms up (approximately 30 seconds).
- If TEST is selected immediately. WAIT will be displayed until Antenna is synchronized (less than 4 seconds) and then test pattern will appear.

- |                               |  |
|-------------------------------|--|
| (3) WX/C                      | <p>Alternate-action switch used to select weather mode or cyclic contour mode.</p> <p>If selected at turn-on, system will come up in weather-mode; second depression of switch will select cyclic contour mode.</p> <p>If selected when system is already operating in another mode, system will return to weather mode; second switch depression will select cyclic contour mode.</p> <p>In cyclic contour mode, 3-level (red) display will flash on and off at a 0.5 second intervals.</p> |
| (4) MAP                       | Pushbutton switch used to select ground mapping mode.  |
| (5) TEST                      | Pushbutton switch used to select test mode. Special test pattern is displayed. In test, transmitter does not transmit and range is automatically 100 n.m.  |
| (6) FRZ                       | Pushbutton switch used to select freeze mode. Radar display is not updated with incoming target return data. As a warning to the pilot, FRZ level will flash on and off at 0.5 second intervals.   |
| (7) AZ MK                     | Slide switch used to display three-azimuth markers at 30-degree intervals.   |
| (8) TILT                      | Rotary control that enables pilot to select angles of antenna beam tilt with relation to airframe. Rotating control CW tilts beam upward; CCW rotation tilts beam downward.  |
| (9) 10/25/50/100<br>(DI-1005) | Pushbutton switches used to select desired range. Five range marks are displayed for each range.   |

**SECTION 2 - LIMITATIONS**

Do not operate radar within 15 feet of ground personnel or when refueling operations are within 100 feet of aircraft.

**SECTION 3 - EMERGENCY PROCEDURES**

There are no changes to the emergency procedures with this equipment installed.

**SECTION 4 - NORMAL PROCEDURES**

- (a) Preliminary Control Settings
- (1) Place the Indicator Control in the following positions before applying power from the aircraft electrical system:
- a. INTensity control..... Fully counterclockwise, in OFF
  - b. TILT control..... Fully upward
  - c. RANGE switch ..... 10 nautical miles

NOTE

Control settings in this position will produce minimum hazards to ground personnel should the radar be activated.

(b) Operational Control Settings

- (1) Rotate INTensity control clockwise to bring system into ON condition.
- (2) Note that STBY is displayed until a mode is selected.
- (3) Depress WX and note that WAIT is displayed during remaining portion of warm-up period.
- (4) When WX is displayed, rotate INTensity control clockwise until display brightness is at desired level.
- (5) Set RANGE switch to desired range.
- (6) Adjust TILT control for desired forward scan area.

NOTE

To place radar in STBY mode after it has been operating, rotate INT control momentarily to OFF, then back to desired viewing position. Radar will then remain in STBY with no radiated power until an operating mode is selected.

CAUTION

- If the radar is to be operated while the aircraft is on the ground.
- a. Direct nose of aircraft such that antenna scan sector is free of large metallic objects (hangars, other aircraft) for a distance of 100 feet (30 meters), and tilt antenna fully upward.
  - b. Avoid operation during refueling of aircraft or during refueling operations within 100 feet (30 meters).
  - c. Prevent personnel from standing within 15 feet from the radiating antenna.

SECTION 5 - PERFORMANCE

Installation of the RCA Weather Scout II Color Weather Radar does not affect the basic performance information presented in Section 5 of this handbook.

Airborne Division  
Parker Hannifin Corporation  
711 Taylor Street  
Elyria, Ohio 44035

FAA APPROVED  
AIRPLANE FLIGHT MANUAL SUPPLEMENT  
FOR  
PIPER PA-34-200T SENECA II

Ser. Nos. A11 34-8070084

Reg. No. N35727

This supplement must be attached to the FAA Approved Airplane Flight Manual when Airborne Pneumatic Wing and Tail Deice System 711A or 711B are installed in accordance with STC SA473GL. The information contained herein supplements or supersedes the basic manual only in those areas listed herein. For limitations, procedures and performance information not contained in this supplement, consult the basic airplane flight manual.

FAA APPROVED

*Charles E. Arnold*  
*for* W. F. Horn

Chief, Engineering & Manufacturing  
Branch, AGL-210  
Federal Aviation Administration  
Great Lakes Region, Des Plaines, IL

DATE NOV 21 1980

FAA APPROVED  
DATE: NOV 21 1980

AIRBORNE DEICE SYSTEM 711A & 711B, AFM/POH SUPPLEMENT

SECTION 1 - GENERAL

This supplement is FAA approved and must be attached to, and used in conjunction with, the basic AFM or POH when the Airborne pneumatic wing and tail deice system is installed in accordance with STC SA473GL.

This supplement provides information necessary for the operation of the aircraft when the Airborne system is installed either separately or in conjunction with certain Piper Ice Protection System items. For limitations, procedures and other data not covered herein, refer to the basic AFM or POH.

SECTION 2 - LIMITATIONS

- (a) Flight into known icing conditions is prohibited for aircraft not equipped as specified in Section 2, paragraph (b) of this supplement.
- (b) For flight in icing conditions, the following equipment must be installed in accordance with Airborne STC SA473GL, Piper drawings or in an FAA approved manner.
  - (1) Airborne 711A or 711B pneumatic wing and empennage deice system and ice detection light.
  - (2) Electrothermal propeller boots.
  - (3) Electric windshield panel.
  - (4) Heated pitot head.
  - (5) Heated lift detectors
  - (6) Propeller spinners
- (c) Placards
  - (1) For aircraft not equipped as specified in Section 2, paragraph (b) - on the pneumatic deice control panel:

WARNING: THIS AIRCRAFT IS  
NOT APPROVED FOR  
FLIGHT IN ICING  
CONDITIONS

AIRBORNE DEICE SYSTEM 711A & 711B, AFM/POH SUPPLEMENT

- (2) On the instrument panel or deice control panel near the surface deice control switch:

NOTICE:  
IF BLUE LIGHT IS ON MORE THAN  
20 SECONDS, MOVE SURFACE DEICE  
SWITCH TO MANUAL OFF POSITION

- (3) On the deice control panel above the ice detection light switch:

WING ICE  
LIGHT ON

- (4) On the deice control panel between the ice detection light switch and the blue indicator light:

OFF

WING & TAIL

- (5) On the deice control panel below the blue indicator light:

DEICERS

AIRBORNE DEICE SYSTEM 711A & 711B, AFM/POH SUPPLEMENT

SECTION 3 - EMERGENCY PROCEDURES

The Emergency Procedures provided in the basic AFM/POH are applicable in their entirety and do not require any change for this supplement.

Additional Emergency Procedures specifically applicable to the Airborne pneumatic deice system are provided as follows:

(a) BOOTS FAIL TO DEFLATE AND/OR

BLUE INDICATOR LIGHT STAYS ON MORE THAN 20 SECONDS

- (1) Press surface deice switch to "Manual Off" position.
- (2) Pull "Wing-Tail Deicers" circuit breaker, if necessary.
- (3) Do not attempt to reactivate the pneumatic boot system with less than 1/4 inch of ice accumulation--operation of the boots with less than 1/4 inch ice accumulation can result in inability to remove existing or continuing ice build-up.



AIRBORNE DEICE SYSTEM 711A & 711B, AFM/POH SUPPLEMENT

SECTION 4 - NORMAL PROCEDURES

PRE-FLIGHT

Pre-flight procedures for Piper Ice Protection System equipment installed in conjunction with the Airborne pneumatic wing and tail deice system are provided in the basic AFM or POH and related supplements.

Additional pre-flight procedures applicable to the Airborne pneumatic deice system are as follows:

- (a) Examine boots for damage. Replace boots or repair damage before dispatch into forecast icing conditions.
- (b) Turn on ice detection light and check for operation.

CAUTION  
ICE LIGHT BECOMES VERY HOT

- (c) With engines running at cruise RPM,
  - (1) Press deice switch to "on" position.
  - (2) Blue indicator light should come on during boot inflation and extinguish within 10 seconds.
  - (3) Press deice switch to "on" position. While the blue light is on (before the boots reach maximum inflation pressure), press deice switch to manual off. Blue light should extinguish and boots should return to deflated position.

CAUTION  
CONTINUOUS RAPID CYCLING OF PNEUMATIC  
BOOT SYSTEM SHOULD BE AVOIDED

## AIRBORNE DEICE SYSTEM 711A & 711B, AFM/POH SUPPLEMENT

### IN-FLIGHT

For aircraft fully equipped as specified in Section 2, paragraph (b) of this supplement, the basic AFM or POH and related supplements provide the normal procedures for flight into known icing conditions. No additional procedures for the Airborne system are required.

For aircraft equipped with only the Airborne wing and tail pneumatic deice system, the following procedures apply in the event of an inadvertent icing encounter.

- (a) Take immediate action to fly out of icing conditions.
- (b) If ice continues to build up, allow 1/4 to 1/2 inch of ice to accumulate.
- (c) Press deice switch to "on" position to cycle boots and remove ice.
- (d) Repeat steps (b) & (c) as required.

#### WARNING

DO NOT CYCLE PNEUMATIC BOOTS WITH LESS THAN 1/4 INCH OF ICE ACCUMULATION. OPERATION OF THE BOOTS WITH LESS THAN 1/4 INCH ICE ACCUMULATION CAN RESULT IN INABILITY TO REMOVE EXISTING OR CONTINUING ICE BUILD-UP.

### SECTION 5 - PERFORMANCE

Information regarding changes in aircraft performance with ice protection equipment installed is provided in the basic AFM or POH.

### SECTION 6 - SYSTEM DESCRIPTION AND OPERATION

The description and operation of the Airborne pneumatic wing and tail deice system is identical to the Piper Ice Protection System except as follows:

## AIRBORNE DEICE SYSTEM 711A & 711B, AFM/POH SUPPLEMENT

Actuation of the surface deice switch activates the pneumatic system control valves and closes the circuit for the blue light on the deice control panel. The blue light indicates that the boot inflation cycle has been activated. When the boots have inflated to their normal operating pressure, a pressure sensing switch deactivates the control valves and turns the inflation indicator light off. The boots then deflate and the system returns to the vacuum hold-down mode.

### SECTION 7 - HANDLING, SERVICING AND MAINTENANCE

Information regarding routine servicing and maintenance of the deice boots is provided in the basic AFM or POH.

Adjustment, servicing and maintenance instructions for the Airborne pneumatic wing and tail deice system are provided in the 711 Kit Installation Manual. This manual should remain with the aircraft or be otherwise readily available to persons performing work on the system.

-END-

Aeronautical Testing Service, Inc.  
18820 59th Drive NE  
Arlington, WA 98223  
STC SA00109SE

STC SA00109SE

Report ATS 94-04b

AERONAUTICAL TESTING SERVICE, INC.

FAA APPROVED

PILOT'S OPERATING HANDBOOK SUPPLEMENT

for

**PIPER SENECA II**

**SERIAL NUMBERS 34-7770001 THROUGH 34-8170092**

This Pilot's Operating Handbook Supplement must be carried in the airplane when an ATS Vortex Generator Kit is installed in accordance with STC SA00109SE. The information contained herein supplements or supersedes the information in the airplane markings, placards, and handbook only in those areas listed herein. For limitations, procedures, and performance information not contained in this supplement, consult the airplane markings, placards, and handbook.

FAA Approved:



---

Manager, Aircraft Modification Branch  
Seattle Aircraft Certification Office

Date: August 4, 1994

### Airplane Flight Manual Supplement Log of Revisions

Revision	Revised Pages	Description of Revision	FAA Approval and Date

94-04b

### Airplane Flight Manual Supplement Log of Pages

Pages	Revision Number	Date
Title Page	Original Issue	August 3, 1994
i	"	"
ii	"	"
iii	"	"
1-1	"	"
2-1	"	"
2-2	"	"
3-1	"	"
4-1	"	"
6-1	"	"

ATS 94-04b

## TABLE OF CONTENTS

<b>SECTION 1</b>	<b>GENERAL</b>
<b>SECTION 2</b>	<b>LIMITATIONS</b>
<b>SECTION 3</b>	<b>EMERGENCY PROCEDURES</b>
<b>SECTION 4</b>	<b>NORMAL PROCEDURES</b>
<b>SECTION 6</b>	<b>WEIGHT AND BALANCE</b>

**SECTION 1  
GENERAL**

**NO CHANGES EXCEPT:**

**1.1 INTRODUCTION**

The purpose of the ATS, Inc. VG Kit is to improve stall characteristics and to reduce  $V_{MCA}$  through control of boundary layer airflow. Although the ATS, Inc. VG Kit reduces  $V_{MCA}$ , the pilot is encouraged to fly by reference to the performance specifications in the airplane markings, placards, and handbook to provide an increased margin of safety. The ATS, Inc. modification consists of fifty (50) vortex generators mounted on the wings and vertical fin and a split flap at the trailing edge of the flap. If more than four vortex generators are missing or damaged, the aircraft must be flown in accordance with the original markings, placards, and handbook. If more than six vortex generators are missing or damaged, the aircraft is not airworthy and must be repaired before flight.

**1.11 MAXIMUM WEIGHTS**

(c) Maximum Zero Fuel Weight (lbs) - Standard 4168

The new Zero Fuel Weight envelope is:

CG Position (inches)	Weight (lbs)
94.60	4168
86.41 to 94.60	4000
82.00 to 94.60	3400

Straight line variation between the points above.



**SECTION 2  
LIMITATIONS**

**NO CHANGES EXCEPT:**

**2.1 GENERAL**

The purpose of the ATS, Inc. VG Kit is to improve stall characteristics and to reduce  $V_{MCA}$  through control of boundary layer airflow. Although the ATS, Inc. VG Kit reduces  $V_{MCA}$ , the pilot is encouraged to fly by reference to the performance specifications in the airplane markings, placards, and handbook to provide an increased margin of safety. The ATS, Inc. modification consists of fifty (50) vortex generators mounted on the wings and vertical fin and a split flap at the trailing edge of the flap. If more than four vortex generators are missing or damaged, the aircraft must be flown in accordance with the original markings, placards, and handbook. If more than six vortex generators are missing or damaged, the aircraft is not airworthy and must be repaired before flight.

**2.3 AIRSPEED LIMITATIONS**

SPEED	KIAS	KCAS
Air Minimum Control Speed ( $V_{MC}$ ) - Lowest airspeed at which airplane is controllable with one engine operating, no flaps, and a five degree bank into the operating engine.	61	62

**2.5 AIRSPEED INDICATOR MARKINGS**

MARKING	KIAS
Radial Red Line (Minimum Control Speed - Single Engine)	61

A 94-04b

**SECTION 2  
LIMITATIONS**

ATS, Inc.  
POH Supplement for Piper Seneca II  
STC SA00109SE

**2.11 WEIGHT LIMITS**

(d) Maximum Zero Fuel Weight - Standard (See pages 6-61 and 6-62.) **4168 LBS**

The new Zero Fuel Weight envelope is:

CG Postion (inches)	Weight (lbs)
94.60	4168
86.41 to 94.60	4000
82.00 to 94.60	3400

Straight line variation between the points above.

**NO CHANGES EXCEPT:**

**2.33 PLACARDS**

In full view of the pilot:

MAXIMUM TAKEOFF WEIGHT 4570 POUNDS  
MAXIMUM LANDING WEIGHT 4342 POUNDS  
MAXIMUM ZERO FUEL WEIGHT VARIES  
WITH CENTER OF GRAVITY POSITION  
CONSULT POH SUPPLEMENT

In full view of the pilot:

MINIMUM SINGLE ENGINE CONTROL SPEED 61 KIAS

**SECTION 3**  
**EMERGENCY PROCEDURES**

**NO CHANGES EXCEPT:**

**3.3 EMERGENCY CHECK LIST**

**AIRSPEEDS FOR SAFE OPERATION**

Minimum Single Engine Control . . . . . 61 KIAS

**ENGINE INOPERATIVE PROCEDURES**

Minimum control speed . . . . . 61 KIAS

**3.7 ENGINE INOPERATIVE PROCEDURE**

**ENGINE SECURING PROCEDURE (FEATHERING PROCEDURE)**

Keep in mind that the minimum single engine control speed is 61 KIAS and the best single engine rate of climb is 89 KIAS when beginning the feathering procedure.

**ENGINE FAILURE DURING TAKEOFF**

The single engine minimum control speed for this airplane is 61 KIAS under standard conditions.

**ENGINE FAILURE DURING CLIMB**

The single engine minimum control speed for this airplane is 61 KIAS under standard conditions.

94-04b

**SECTION 4**  
**NORMAL PROCEDURES**

**NO CHANGES EXCEPT:**

**4.51  $V_{MCA}$  - MINIMUM SINGLE-ENGINE CONTROL SPEED**

$V_{MCA}$  is the airspeed below which a twin-engine aircraft cannot be controlled in flight with one engine operating at takeoff power and the other engine windmilling and a five degree bank into the operating engine.  $V_{MCA}$  for the Seneca II has been determined to be 61 KIAS.

**4.53 STALLS**

The loss of altitude during a power off stall with the gear and flaps retracted may be as much as 300 feet. The loss of altitude with the gear down and 40° of flaps may also be as much as 300 feet.

A power on stall may result in as much as 150 feet of altitude loss.

**SECTION 6**  
**WEIGHT AND BALANCE**

**NO CHANGES EXCEPT:**

**6.1 GENERAL**

The addition of the ATS, Inc. Vortex Generator Kit increases the Zero Fuel Weight of Seneca II aircraft. Use the following C.G. Envelope Diagram .

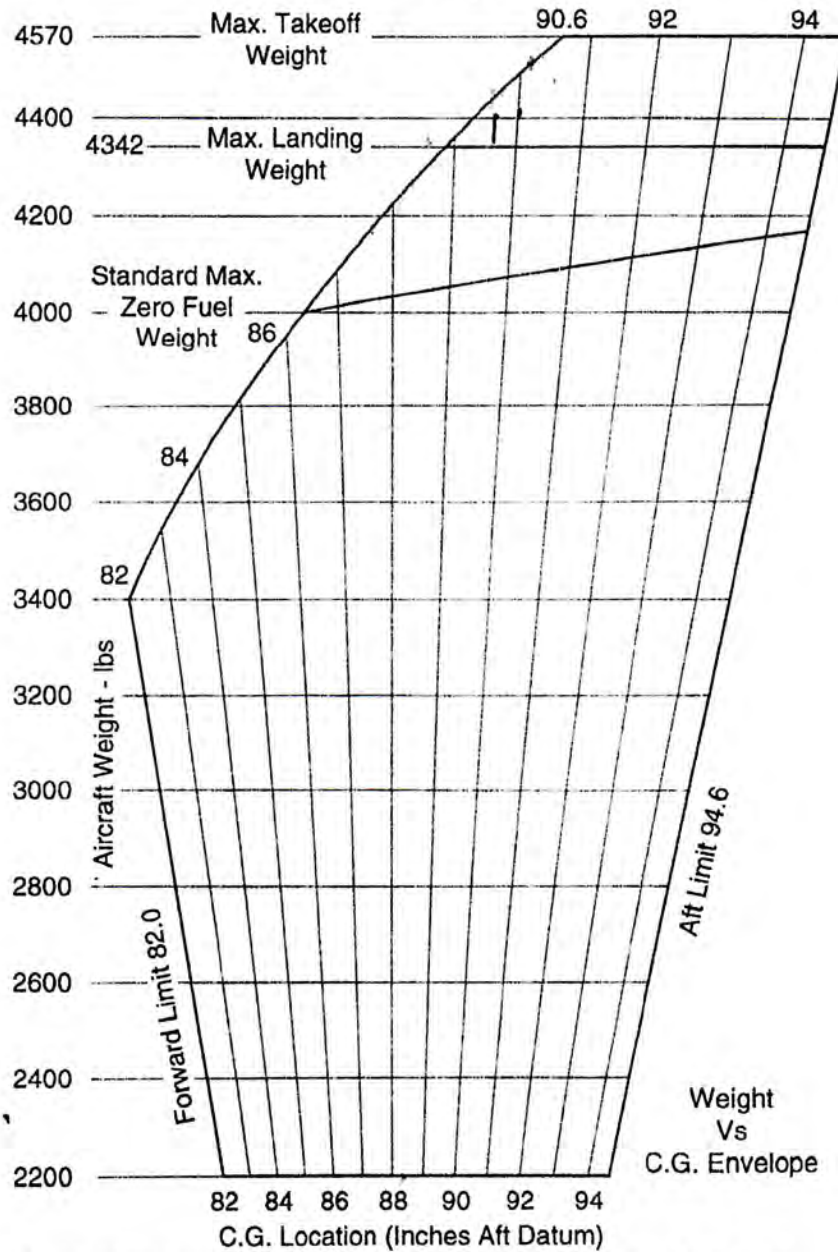

Moment change due to retracting Landing Gear = -32 in.-lbs.

**C.G. RANGE AND WEIGHT**

For optional equipment Zero Fuel Weight increase see P.O.H.

94-04b

Garmin International, Inc.  
1200 E. 151<sup>st</sup> Street  
Olathe, Kansas 66062 U.S.A.

FAA APPROVED

AIRPLANE FLIGHT MANUAL SUPPLEMENT  
or  
SUPPLEMENTAL AIRPLANE FLIGHT MANUAL  
for the  
Garmin GNS 400W, 420W, 420AW, 430W, or 430AW  
GPS/SBAS Navigation System  
as installed in

Piper Seneca II

Make and Model Airplane

Registration Number: N35727 Serial Number: 34-8070084

This document serves as an Airplane Flight Manual Supplement or as a Supplemental Airplane Flight Manual when the aircraft is equipped with the Garmin GNS 400W, 420W, 420AW, 430W, or 430AW GPS/SBAS Navigation System. This document must be carried in the airplane at all times when the Garmin GNS unit is installed in accordance with STC SA01933LA-D. This document must be incorporated into the FAA Approved Airplane Flight Manual or provided as an FAA Approved Supplemental Airplane Flight Manual.

The information contained herein supplements the information in the FAA Approved Airplane Flight Manual. For limitations, procedures, loading and performance information not contained in this document, refer to the FAA Approved Airplane Flight Manual, markings, or placards.

FAA Approved By:



Michael Warren  
ODA STC Unit Administrator  
Garmin International, Inc.  
ODA-240087-CE

Date: 20-NOV-2014

LOG OF REVISIONS				
Rev. No.	Page		Description	FAA Approved
	No.	Date		
A Original	All	11-20-07	Complete Supplement	<u>Seyed-Youssef Hashemi</u> Mgr. Flt. Test Br., ANM-160L FAA, Los Angeles ACO Transport Airplane Directorate  Date: <u>Nov. 20, 2007</u>
B	All	07/31/09	Added '-D' to STC number, added LP approach type	<u>David G Armstrong</u>  ODA STC Unit Administrator ODA-240087-CE Garmin International, Inc.
C	All	03/21/13	Complete Rewrite	<u>Michael Warren</u>  ODA STC Unit Administrator ODA-240087-CE Garmin International, Inc.
D	10, 14	01/27/14	Added LP +V approach type	<u>Michael Warren</u>  ODA STC Unit Administrator ODA-240087-CE Garmin International, Inc.
E	8,9  11  13,14  21  22	11/20/2014	Updated document revisions and added Flight Stream 210  Added note for Flight Stream 210  Added sections 2.14 and 2.15  Updated GTN Crossfill section  Added Section 7.3	See Page 1

## Table of Contents

SECTION	PAGE
<b>Section 1. GENERAL</b>	<b>4</b>
1.1 Garmin 4XXW Series GPS/WAAS Nav Com	4
1.2 GPS/SBAS TSO-C146a Class 3 Operation	5
<b>Section 2. LIMITATIONS</b>	<b>7</b>
2.1 Pilot's Guide	7
2.2 Kinds of Operation	7
2.3 System Software	8
2.4 Navigation database	8
2.5 Flight Planning	9
2.6 Approaches	10
2.7 Autopilot Coupling	11
2.8 Terrain Proximity Function	11
2.9 VNAV – Vertical Navigation Calculation Page	12
2.10 Weather Display (Optional)	12
2.11 Traffic Display (Optional)	12
2.12 Manual GTN Crossfill	12
2.13 Flight Stream 210 (Optional)	12
<b>Section 3. EMERGENCY PROCEDURES</b>	<b>14</b>
3.1 Emergency Procedures	14
3.2 Abnormal Procedures	14
<b>Section 4. NORMAL PROCEDURES</b>	<b>16</b>
4.1 Unit Power On	16
4.2 Before Takeoff	16
4.3 HSI and EHSI Operation	17
4.4 Autopilot Operation	17
4.5 Coupling the Autopilot during approaches	18
4.6 Traffic Mode Selection (Optional)	19
<b>Section 5. PERFORMANCE</b>	<b>19</b>
<b>Section 6. WEIGHT AND BALANCE</b>	<b>19</b>
<b>Section 7. SYSTEM DESCRIPTIONS</b>	<b>20</b>
7.1 Pilot's Guide	20
7.2 Manual GTN Crossfill	20
7.3 Flight Stream 210	20



## Section 1. GENERAL

### 1.1 Garmin 4XXW Series GPS/WAAS Nav Com

The Garmin GNS Series GPS/WAAS Navigator is a panel-mounted product that contains a GPS/WAAS receiver for GPS approved primary navigation under TSO-C146a, (plus optional VHF Com and VHF Nav radios) in an integrated unit with a moving map and color display. The 4XXW Series unit features a graphical display which may also be used to depict traffic, weather, or terrain data.

The navigation functions are operated by dedicated keys and graphical menus which are controlled by the buttons and the dual concentric rotary knob along the bottom and right side of the display.

Optional VHF Com and VHF Nav radio functions are controlled via dedicated buttons and knobs on the left side of the display and adjacent to frequencies they are controlling.



Figure 1 - 430W Series Control and Display Layout

## **1.2 GPS/SBAS TSO-C146a Class 3 Operation**

The GNS complies with AC 20-138A and has airworthiness approval for navigation using GPS and SBAS (within the coverage of a Satellite Based Augmentation System complying with ICAO Annex 10) for IFR en route, terminal area, and non-precision approach operations (including those approaches titled “GPS”, “or GPS”, and “RNAV (GPS)” approaches). The Garmin GNSS navigation system is composed of the GNS navigator and antenna, and is approved for approach procedures with vertical guidance including “LPV” and “LNAV/VNAV” and without vertical guidance including “LP” and “LNAV,” within the U.S. National Airspace System.

The Garmin GNSS navigation system complies with the equipment requirements of AC 90-105 and meets the equipment performance and functional requirements to conduct RNP terminal departure and arrival procedures and RNP approach procedures without RF (radius to fix) legs. Part 91 subpart K, 121, 125, 129, and 135 operators require operational approval from the FAA.

The Garmin GNSS navigation system complies with the equipment requirements of AC 90-100A for RNAV 2 and RNAV 1 operations. In accordance with AC 90-100A, Part 91 operators (except subpart K) following the aircraft and training guidance in AC 90-100A are authorized to fly RNAV 2 and RNAV 1 procedures. Part 91 subpart K, 121, 125, 129, and 135 operators require operational approval from the FAA.

***Applicable to dual installations consisting of two Garmin GNSS units:*** The Garmin GNSS navigation system has been found to comply with the requirements for GPS Class II oceanic and remote navigation (RNP-10) without time limitations in accordance with AC 20-138A and FAA Order 8400.12A. The Garmin GNSS navigation system can be used without reliance on other long-range navigation systems. This does not constitute an operational approval.

The Garmin GNSS navigation system has been found to comply with the navigation requirements for GPS Class II oceanic and remote navigation (RNP-4) in accordance with AC 20-138A and FAA Order 8400.33. The Garmin GNSS navigation system can be used without reliance on other long-range navigation systems. Additional equipment may be required to obtain operational approval to utilize RNP-4 performance. This does not constitute an operational approval.

The Garmin GNSS navigation system complies with the accuracy, integrity, and continuity of function, and contains the minimum system functions required for P-RNAV operations in accordance with JAA Administrative & Guidance Material Section One: General Part 3: Temporary Guidance Leaflets, Leaflet No 10 (JAA TGL-10 Rev 1). The GNSS navigation system has one or more TSO-C146a Class 3 approved Garmin GNS Navigation Systems. The Garmin GNSS navigation system complies with the accuracy, integrity, and continuity of function, and contains the minimum system functions required for B-RNAV operations in accordance with EASA AMC 20-4. The Garmin GNSS navigation system complies with the equipment requirements for P-RNAV and B-RNAV/RNAV-5 operations in accordance with AC 90-96A CHG 1. This does not constitute an operational approval.

Garmin International holds an FAA Type 2 Letter of Acceptance (LOA) in accordance with AC 20-153 for database integrity, quality, and database management practices for the navigation database. Flight crew and operators can view the LOA status at [FlyGarmin.com](http://FlyGarmin.com) then select "Type 2 LOA Status."

Navigation information is referenced to the WGS-84 reference system.

Note that for some types of aircraft operation and for operation in non-U.S. airspace, separate operational approval(s) may be required in addition to equipment installation and airworthiness approval.

## Section 2. LIMITATIONS

### 2.1 Pilot's Guide

The Quick Reference Guide, part number and revision listed below (or later applicable revisions), must be immediately available for the flight crew whenever navigation is predicated on the use of the 4XXW Series unit.

- 400W Series Quick Reference Guide P/N 190-00356-01 Rev J

The Pilot's Guide Addendum, part number and revision listed below (or later applicable revision), must be immediately available for the flight crew whenever one or more of the following units are installed and utilized with the 4XXW Series unit:

GDL 69/69A XM Satellite Data link  
GDL 88 ADS-B Transceiver  
GTX 330/330D TIS  
GTS 8XX Series TAS  
Flight Stream 210

- 400W/500W Series Optional Displays P/N 190-00356-30 Rev L

The Pilot's Guide Addendum, part number and revision listed below (or later applicable revision), must be immediately available for the flight crew whenever one or more of the following units are installed and utilized with the 4XXW Series unit:

Stormscope® Lightning Detection System  
Skywatch® Traffic Advisory System  
Bendix/King® Traffic Advisory System  
Avidyne/Ryan TCAD Traffic System

- 400W/500W Series Display Interfaces P/N 190-00356-31 Rev D

### 2.2 Kinds of Operation

This AFM supplement does not grant approval for IFR operations to aircraft limited to VFR operations. Additional aircraft systems may be required for IFR operational approval. Systems limited to VFR shall be placarded in close proximity to the 4XXW Series unit: **"GPS LIMITED TO VFR USE ONLY"**.

### 2.3 System Software

This AFMS/AFM is applicable to the software versions shown in Table 1.

The Main and GPS software versions are displayed on the start-up page immediately after power-on.

Software Item	Approved Software Version <i>(or later FAA approved versions for this STC)</i>	
	SW version	As displayed on unit
Main SW Version	5.20	5.20
GPS SW Version	5.0	5.0
Flight Stream 210	2.11	2.11 (Displayed on GNS)

**Table 1 – Required Equipment**

### 2.4 Navigation database

GPS/SBAS based IFR enroute, oceanic, and terminal navigation is prohibited unless the flight crew verifies and uses a valid, compatible, and current navigation database or verifies each waypoint for accuracy by reference to current approved data.

“GPS”, “or GPS”, and “RNAV (GPS)” instrument approaches using the Garmin navigation system are prohibited unless the flight crew verifies and uses the current navigation database. GPS based instrument approaches must be flown in accordance with an approved instrument approach procedure that is loaded from the navigation database.

Discrepancies that invalidate a procedure should be reported to Garmin International. The affected procedure is prohibited from being flown using data from the navigation database until a new navigation database is installed in the aircraft and verified that the discrepancy has been corrected. Navigation database discrepancies can be reported at [FlyGarmin.com](http://FlyGarmin.com) by selecting “Aviation Data Error Report.” Flight crew and operators can view navigation database alerts at [FlyGarmin.com](http://FlyGarmin.com) then select “NavData Alerts.”

If the navigation database cycle will change during flight, the flight crew must ensure the accuracy of navigation data, including suitability of navigation facilities used to define the routes and procedures for flight. If an amended chart affecting navigation data is published for the procedure, the database must not be used to conduct the procedure.

## 2.5 Flight Planning

For flight planning purposes, in areas where SBAS coverage is not available, the flight crew must check RAIM availability.

- Within the United States, RAIM availability can be determined using the Garmin WFDE Prediction program, Garmin part number 006-A0154-04 software version 3.00 or later approved version with Garmin approved antennas or the FAA's enroute and terminal RAIM prediction website: [www.raimprediction.net](http://www.raimprediction.net), or by contacting a Flight Service Station.
- Within Europe, RAIM availability can be determined using the Garmin WFDE Prediction program or Europe's AUGER GPS RAIM Prediction Tool at <http://augur.ecacnav.com/augur/app/home>.
- For other areas, use the Garmin WFDE Prediction program.

This RAIM availability requirement is not necessary if SBAS coverage is confirmed to be available along the entire route of flight. The route planning and WFDE prediction program may be downloaded from the Garmin website on the internet. For information on using the WFDE Prediction Program, refer to Garmin WAAS FDE Prediction Program, part number 190-00643-01, 'WFDE Prediction Program Instructions'.

For flight planning purposes, for operations within the U.S. National Airspace System on RNP and RNAV procedures when SBAS signals are not available, the availability of GPS RAIM shall be confirmed for the intended route of flight. In the event of a predicted continuous loss of RAIM of more than five minutes for any part of the intended route of flight, the flight shall be delayed, canceled, or rerouted on a track where RAIM requirements can be met. The flight may also be re-planned using non-GPS based navigational capabilities.

For flight planning purposes for operations within European B-RNAV/RNAV-5 and P-RNAV airspace, if more than one satellite is scheduled to be out of service, then the availability of GPS RAIM shall be confirmed for the intended flight (route and time). In the event of a predicted continuous loss of RAIM of more than five minutes for any part of the intended flight, the flight shall be delayed, canceled, or rerouted on a track where RAIM requirements can be met.

### *Applicable to dual installations consisting of two Garmin GNSS units:*

For flight planning purposes, for operations where the route requires Class II navigation the aircraft's operator or flight crew must use the Garmin WFDE Prediction program to demonstrate that there are no outages on the specified route that would prevent the Garmin GNSS navigation system to provide GPS Class II navigation in oceanic and remote areas of operation that requires RNP-10 or RNP-4 capability. If the Garmin WFDE Prediction program indicates fault exclusion (FDE) will be unavailable for more than 34 minutes in accordance with FAA Order 8400.12A for RNP-10 requirements, or 25 minutes in accordance with FAA Order 8400.33 for RNP-4 requirements, then the operation must be rescheduled when FDE is available.

Both Garmin GPS navigation receivers must be operating and providing GPS navigation guidance for operations requiring RNP-4 performance.

North Atlantic (NAT) Minimum Navigational Performance Specifications (MNPS) Airspace operations per AC 91-49 and AC 120-33 require both GPS/SBAS receivers to be operating and receiving usable signals except for routes requiring only one Long Range Navigation sensor. Each display computes an independent navigation solution based on its internal GPS receiver.

Whenever possible, RNP and RNAV routes including Standard Instrument Departures (SIDs), and Standard Terminal Arrival (STAR), routes should be loaded into the flight plan from the database in their entirety, rather than loading route waypoints from the database into the flight plan individually. Selecting and inserting individual named fixes from the database is permitted, provided all fixes along the published route to be flown are inserted. Manual entry of waypoints using latitude/longitude or place/bearing is prohibited.

#### **NOTE**

If flight plan information is imported from a portable electronic device utilizing the Flight Stream 210, all waypoints and flight plan information must be verified by the crew.

It is not acceptable to flight plan a required alternate airport based on RNAV(GPS) LP/LPV or LNAV/VNAV approach minimums. The required alternate airport must be flight planned using an LNAV approach minimums or available ground-based approach aid.

Navigation information is referenced to the WGS-84 reference system, and should only be used where the Aeronautical Information Publication (including electronic data and aeronautical charts) conform to WGS-84 or equivalent.

## **2.6 Approaches**

- Instrument approaches using GPS guidance may only be conducted when the GNS is operating in the approach mode. (LNAV, LNAV+V, L/VNAV, LPV, LP, or LP +V)

#### **NOTE**

*Advisory* vertical guidance deviation is provided when the GNS annunciates LNAV+V or LP +V. The controlling minimums remain LNAV or LP even when advisory vertical guidance is provided. Advisory vertical guidance information displayed on the VDI in this mode is only an aid to help flight crews comply with altitude restrictions. When using advisory vertical guidance, the flight crew must use the primary barometric altimeter to ensure compliance with all altitude restrictions in

accordance with the LNAV or LP approach procedure.

- When conducting instrument approaches referenced to true North, the NAV Angle on the AUX-Units/Position page must be set to **True**.
- The navigation equipment required to join and fly an instrument approach procedure is indicated by the title of the procedure and notes on the IAP chart. Navigating the final approach segment (that segment from the final approach fix to the missed approach point) of an ILS, LOC, LOC-BC, LDA, SDF, MLS, VOR, TACAN approach, or any other type of approach not approved for GPS, is not authorized with GPS navigation guidance. GPS guidance can only be used for approach procedures with GPS or RNAV in the procedure title. When using the Garmin VOR/LOC/GS receivers to fly the final approach segment, VOR/LOC/GS navigation data must be selected and presented on the CDI of the pilot flying.
- Not all published Instrument Approach Procedures (IAP) are in the navigation database. Flight crews planning to fly an RNAV instrument approach must ensure that the navigation database contains the planned RNAV Instrument Approach Procedure and that approach procedure must be loaded from the navigation database into the GNS system flight plan by its name. Users are prohibited from flying any approach path that contains manually entered waypoints.
- IFR approaches are prohibited whenever any physical or visual obstruction (such as a throw-over yoke) restricts pilot view or access to the GNS and/or the CDI.

## **2.7 Autopilot Coupling**

IFR installations of a Garmin 4XXW Series unit allow the operator to fly all phases of flight based on the navigation information presented to the pilot; however, not all modes may be coupled to the autopilot. All autopilots may be coupled in Oceanic (OCN), Enroute (ENR), and Terminal (TERM) modes; however, the FAA requires that vertical coupling of an autopilot for approaches be demonstrated to meet their intended function and provide safe and proper operation to published minimums. This installation is limited to:

- Lateral coupling only for GPS approaches. Coupling to the vertical path for GPS approaches is not authorized.

## **2.8 Terrain Proximity Function**

Terrain and obstacle information appears on the map and terrain display pages as red and yellow tiles or towers, and is depicted for advisory use only. Aircraft maneuvers and navigation must not be predicated upon the use of the terrain display. Terrain and obstacle information is advisory only and is not equivalent to warnings provided by TAWS.



The terrain display is intended to serve as a situational awareness tool only. By itself, it may not provide either the accuracy or the fidelity on which to base decisions and plan maneuvers to avoid terrain or obstacles.

### **2.9 VNAV – Vertical Navigation Calculation Page**

VNAV information accessible by pressing the “VNAV” button may be utilized for advisory information only. Use of VNAV information for Instrument Approach Procedures does not guarantee Step-Down Fix altitude protection, or arrival at approach minimums in a normal position to land.

### **2.10 Weather Display (Optional)**

This limitation applies to data linked weather products from SiriusXM via a GDL 69/69A or FIS-B via a GDL 88.

Do not use data link weather information for maneuvering in, near, or around areas of hazardous weather. Information provided by data link weather products may not accurately depict current weather conditions.

Do not use the indicated data link weather product age to determine the age of the weather information shown by the data link weather product. Due to time delays inherent in gathering and processing weather data for data link transmission, the weather information shown by the data link weather product may be significantly older than the indicated weather product age.

Do not rely solely upon data link services to provide Temporary Flight Restriction (TFR) or Notice to Airmen (NOTAM) information. Not all TFRs and NOTAMS can be depicted on the GNS.

### **2.11 Traffic Display (Optional)**

Traffic may be displayed on the GNS when connected to an approved optional TCAS I, TAS, TIS, or ADS-B traffic device. These systems are capable of providing traffic monitoring and alerting to the flight crew. Traffic shown on the display may or may not have traffic alerting available. The display of traffic is an aid to visual acquisition and may not be utilized for aircraft maneuvering.

### **2.12 Manual GTN Crossfill**

When Manual GTN Crossfill is in use, the crew must verify each flight plan leg prior to using the GNS to navigate. See section 7.2 for additional information.

### **2.13 Flight Stream 210 (Optional)**

The Flight Stream 210 provides the ability for the crew to import flight plans from a portable electronic device to the GNS. The crew must verify all flight plan and waypoint information imported from a portable electronic device prior to use on the GNS. See section 7.3 for additional information.

### **2.14 Portable Electronic Devices**

This STC does not relieve the operator from complying with the requirements of 91.23 or any other operational regulation regarding portable electronic devices.

**Section 3. EMERGENCY PROCEDURES**

**3.1 Emergency Procedures**

No change.

**3.2 Abnormal Procedures**

**3.2.1 LOSS OF GPS/SBAS NAVIGATION DATA**

When the GPS/SBAS receiver is inoperative or GPS navigation information is not available or invalid, the GNS will enter one of two modes: Dead Reckoning mode (DR) or Loss Of Integrity mode (LOI). The mode is indicated on the GNS by an amber “DR” or “INTEG”.

If the Loss Of Integrity annunciation is displayed, revert to an alternate means of navigation appropriate to the route and phase of flight.

If the Dead Reckoning annunciation is displayed, the map will continue to be displayed with an amber ownship icon. Course guidance will be removed on the CDI. Aircraft position will be based upon the last valid GPS position, then estimated by Dead Reckoning methods. Changes in true airspeed, altitude, heading, or winds aloft can affect the estimated position substantially. Dead Reckoning is only available in Enroute and Oceanic modes. Terminal and Approach modes do not support Dead Reckoning.

**If Alternate Navigation Sources (ILS, LOC, VOR, DME, ADF) Are Available:**

Navigation..... **USE ALTERNATE SOURCES**

**If No Alternate Navigation Sources Are Available:**

DEAD RECKONING (DR) MODE:

Navigation..... **USE GNS**

**NOTE**

All information normally derived from GPS will become less accurate over time.

LOSS OF INTEGRITY (LOI) MODE:

Navigation .....**FLY TOWARDS KNOWN VISUAL CONDITIONS**

**NOTE**

All information derived from GPS will be removed.

**NOTE**

The airplane symbol is removed from all maps. The map will remain centered at the last known position. “No GPS Position” will be annunciated in the center of the map.

**3.2.2 GPS APPROACH DOWNGRADE**

During a GPS LPV, LNAV/VNAV, LP +V, or LNAV+V approach, if GPS accuracy requirements cannot be met by the GPS receiver prior to the Final Approach Fix, the GNS will downgrade the approach. The downgrade will remove vertical deviation indication from the VDI and change the approach annunciation accordingly from LPV, L/VNAV, LP +V, or LNAV+V to LNAV. The approach may be continued using the LNAV only minimums. After the Final Approach Fix has been passed, the approach will be aborted using the indications described below.

During a GPS approach in which GPS accuracy requirements cannot be met by the GPS receiver for any GPS approach type, the GNS will flag all CDI guidance and display a system message “ABORT APPROACH - Loss of Navigation”. Immediately upon viewing the message, the unit will revert to Terminal navigation mode alarm limits. If the position integrity is within these limits lateral guidance will be restored and the GPS may be used to execute the missed approach, otherwise alternate means of navigation must be utilized.

**3.2.3 LOSS OF COM RADIO TUNING FUNCTIONS**

**If alternate COM is available:**

Communications ..... **USE ALTERNATE COM**

**If no alternate COM is available:**

COM RMT XFR key (if installed).....**PRESS AND HOLD FOR 2 SECONDS**

**NOTE**

This procedure will tune the active COM radio the emergency frequency 121.5, regardless of what frequency is displayed on the GNS. Certain failures of the tuning system will automatically tune 121.5 without flight crew action.

## Section 4. NORMAL PROCEDURES

Refer to the 4XXW Series unit Quick Reference Guide defined in paragraph 2.1 on page 7 of this document for normal operating procedures. This includes all GPS operations, VHF COM and NAV, and Multi-Function Display information. For information on TIS traffic or data linked weather, see the Pilot's Guide addendum for optional displays. For information on active traffic device or Stormscope operation and displays see the Pilot's Guide addendum for display interfaces.

The 4XXW Series unit requires a reasonable degree of familiarity to prevent operations without becoming too engrossed at the expense of basic instrument flying in IMC and basic see-and-avoid in VMC. Pilot workload will be higher for pilots with limited familiarity in using the unit in an IFR environment, particularly without the autopilot engaged. Garmin provides training tools with the Pilot's Guide and PC based simulator. Pilots should take full advantage of these training tools to enhance system familiarization.

### 4.1 Unit Power On

Database ..... **REVIEW EFFECTIVE DATES**

Self Test ..... **VERIFY OUTPUTS TO NAV INDICATORS**

Self Test - GPS Remote Annunciator (If Installed):

VLOC .....	<b>ILLUMINATED</b>
GPS .....	<b>ILLUMINATED</b>
INTG.....	<b>ILLUMINATED</b>
TERM .....	<b>ILLUMINATED</b>
WPT .....	<b>ILLUMINATED</b>
APR.....	<b>ILLUMINATED</b>
MSG.....	<b>ILLUMINATED</b>
SUSP.....	<b>ILLUMINATED</b>

### 4.2 Before Takeoff

System Messages and Annunciators ..... **CONSIDERED**

### **4.3 HSI and EHSI Operation**

If an HSI is used to display navigation data from the GNS the pilot should rotate the course pointer as prompted on the GNS.

If an EHSI is used to display navigation data from the GNS the course pointer may autoslew to the correct course when using GPS navigation. When using VLOC navigation the course pointer will not autoslew and must be rotated to the correct course by the pilot. For detailed information about the functionality of the EHSI system, refer to the FAA approved Flight Manual or Flight Manual Supplement for that system.

#### **CAUTION**

The pilot must verify the active course and waypoint for each flight plan leg. The pilot must verify proper course selection each time the CDI source is changed from GPS to VLOC.

### **4.4 Autopilot Operation**

The GNS may be coupled to an optional autopilot, if installed in the aircraft, when operating as prescribed in the LIMITATIONS section of this manual.

Autopilots coupled to the GNS system in an analog (NAV) mode will follow GPS or VHF navigation guidance as they would with existing VOR receivers.

Autopilots that support GPSS or GPS Roll Steering in addition to the analog course guidance will lead course changes, fly arcing procedures, procedure turns, and holding patterns if coupled in GPSS mode.

For autopilot operating instructions, refer to the FAA approved Flight Manual or Flight Manual Supplement for the autopilot.

## 4.5 Coupling the Autopilot during approaches

### CAUTION

When the CDI source is changed on the GNS, autopilot mode may change. Confirm autopilot mode selection after CDI source change on the GNS. Refer to the FAA approved Flight Manual or Flight Manual Supplement for the autopilot.

- This installation prompts the flight crew and requires the pilot to enable the approach outputs just prior to engaging the autopilot in APR mode.

#### To couple an approach:

Once established on the final approach course with the final approach fix as the active waypoint, the GNS will issue a flashing message indication with the following message “APR Guidance Available, Use PROC before A/P APR”.

PROC Button ..... **PRESS**  
“Enable A/P APR Outputs?” ..... **SELECT**  
ENT Button..... **PRESS**

If coupled, Autopilot will revert to ROL mode at this time.

Autopilot..... **ENGAGE APPROACH MODE**

- This installation supports coupling to the autopilot in approach mode once vertical guidance is available.

#### To couple an approach:

Once established on the final approach course with the final approach fix as the active waypoint, the GNS will enable vertical guidance.

Vertical Guidance ..... **CONFIRM AVAILABLE**  
Autopilot..... **ENGAGE APPROACH MODE**

- The autopilot does not support any vertical capture or tracking in this installation.

Analog only autopilots should use APR mode for coupling to LNAV approaches. Autopilots which support digital roll steering commands (GPSS) may utilize NAV mode and take advantage of the digital tracking during LNAV only approaches.

#### **4.6 Traffic Mode Selection (Optional)**

If the GNS is interfaced to a traffic device, the GNS can be used to control the mode of the traffic system. This is accomplished by pressing the cursor knob while on the dedicated traffic page to enter/exit the traffic device menu. It is important to note that while the traffic device menu is active, the current state of the traffic system is *not* displayed. The state of the traffic device is only displayed once the traffic device menu is exited.

#### **Section 5. PERFORMANCE**

No change.

#### **Section 6. WEIGHT AND BALANCE**

See current weight and balance data.



## Section 7. SYSTEM DESCRIPTIONS

### 7.1 Pilot's Guide

See Garmin 4XXW Series unit Pilot's Guide for a complete description of the 4XXW Series unit.

### 7.2 Manual GTN Crossfill

Manual GTN Crossfill is a feature that will keep the GNS system in sync with a flight plan that is being used on the GTN system. The GTN *will not* automatically keep its flight plan in sync with changes made on the GNS system. Manual crossfill feature is "one way" – from the GTN to the GNS.

The GTN systems support a variety of procedure leg types that the GNS systems do not support. As such, it is normal and expected that the flight plan leg that is displayed on the GNS system will not always match the flight plan leg on the GTN system. Departure, arrival and approach procedures contain leg types that the GNS does not support. The GNS typically "skips" over these leg types and provides no guidance. Guidance may be available on the GTN but not on the GNS in these cases. The GNS will sequence the procedure as it normally would if Crossfill were not active. Once a leg type is reached that is supported on both the GTN and GNS systems, the systems will automatically sync to the same leg.

If the GNS is interfaced with a GTN and the GTN Crossfill feature is enabled on the GNS, then auto-switching from GPS to VLOC guidance on the CDI for ILS/LOC approaches will be disabled on the GNS..

If the flight plan on an interfaced GTN is altered while in a hold, the GNS will reinitiate guidance to the holding waypoint and sequence into the hold upon crossing the waypoint.

If the Missed Approach is activated on the GTN prior to reaching the Missed Approach Point, the GTN will automatically resume leg sequencing upon reaching the Missed Approach Point. The GNS will remain suspended upon reaching the Missed Approach Point and leg sequencing must be manually resumed.

### **7.3 Flight Stream 210**

The Flight Stream 210 provides wireless communication of specific flight plan information and GPS sensor data to a PED (Personal Electronic Device) from the GNS.

For details on the operation and features of the Flight Stream 210, please refer to the GNS 400W/500W Series Optional Displays, P/N 190-00356-30 Rev J.

For additional details about the Garmin supported devices and apps for use with the Flight Stream 210, please visit:

[http://garmin.com/connext/supported\\_devices](http://garmin.com/connext/supported_devices)

Garmin International, Inc.  
1200 E. 151<sup>st</sup> Street  
Olathe, Kansas 66062 U.S.A.

FAA APPROVED

AIRPLANE FLIGHT MANUAL SUPPLEMENT  
or  
SUPPLEMENTAL AIRPLANE FLIGHT MANUAL  
for the  
Garmin GTX 33X and GTX 3X5 Transponders with ADS-B  
as installed in

Piper Seneca II  
Make and Model Airplane

Registration Number: N35727 Serial Number: 34-8070084

This document serves as an FAA Approved Airplane Flight Manual Supplement or Supplemental Airplane Flight Manual when the GTX 33X or GTX 3X5 with ADS-B is installed in accordance with Supplemental Type Certificate SA01714WI. This document must be incorporated into the FAA Approved Airplane Flight Manual or provided as an FAA Approved Supplemental Airplane Flight Manual.

The information contained herein supplements the FAA approved Airplane Flight Manual. For limitations, procedures, loading and performance information not contained in this document, refer to the FAA approved Airplane Flight Manual, markings, or placards.

FAA Approved By: Erik Frisk

Erik Frisk  
ODA STC Unit Administrator  
Garmin International, Inc.  
ODA-240087-CE

Date: 21-DEC-2017

LOG OF REVISIONS				
Revision Number	Page		Description	FAA Approved
	Date	Number		
1	05/01/2013	All	Complete Supplement	<u><i>Robert Murray</i></u> Robert Murray ODA STC Unit Administrator Garmin International, Inc. ODA-240087-CE Date: <u><i>05/01/2013</i></u>
2	03/08/2016	All	New supplement format with GTX 3X5 added.	<u><i>Michael Warren</i></u> Michael Warren ODA STC Unit Administrator Garmin International, Inc. ODA-240087-CE Date: <u><i>03/08/2016</i></u>
3	12/07/2017	All	Updated SW versions and removed section 3.2.3. Updated section 2.2 Corrected PED FAR reference and additional minor corrections.	See cover page

## Table of Contents

SECTION	PAGE
<b>Section 1. GENERAL</b>	<b>4</b>
1.1 GTX 33X	4
1.2 GTX 3X5	6
1.3 Capabilities	8
1.4 Installation Configuration	8
1.5 Definitions	11
<b>Section 2. LIMITATIONS</b>	<b>12</b>
2.1 Minimum Equipment	12
2.2 ADS-B Out	12
2.3 TIS Traffic Display with User Navigation Angle	12
2.4 Applicable System Software	13
2.5 Pressure Altitude Broadcast Inhibit (PABI)	13
2.6 Datalinked Weather Display (GTX 345 Only)	13
2.7 Portable Electronic Devices	13
<b>Section 3. EMERGENCY PROCEDURES</b>	<b>14</b>
3.1 Emergency Procedures	14
3.2 Abnormal Procedures	14
<b>Section 4. NORMAL PROCEDURES</b>	<b>15</b>
4.1 Unit Power On	15
4.2 Before Takeoff	16
<b>Section 5. PERFORMANCE</b>	<b>16</b>
<b>Section 6. WEIGHT AND BALANCE</b>	<b>16</b>
<b>Section 7. SYSTEM DESCRIPTION</b>	<b>17</b>
7.1 GTX TIS Behavior	17
7.2 GTX 345R and G950/1000 No Bearing Traffic Alerts	17

## Section 1. GENERAL

### 1.1 GTX 33X

The Garmin GTX 33X family consists of the GTX 330 ES and GTX 33 ES (Non-Diversity Mode S Transponders) and the GTX 330D ES and GTX 33D ES (Diversity Mode S Transponders). The ES option of any of the transponders provides ADS-B extended squitter functionality.

All Garmin GTX 33X transponders are a radio transmitter/receiver that operates on radar frequencies, receiving ground radar or TCAS interrogations at 1030 MHz and transmitting a coded response of pulses to ground-based radar on a frequency of 1090 MHz. Each unit is equipped with IDENT capability to initiate the SPI (special position identification) pulse for 18 seconds and will reply to ATCRBS Mode A, Mode C and Mode S All-Call interrogation. Interfaces to the GTX 33X are shown in the following block diagrams.

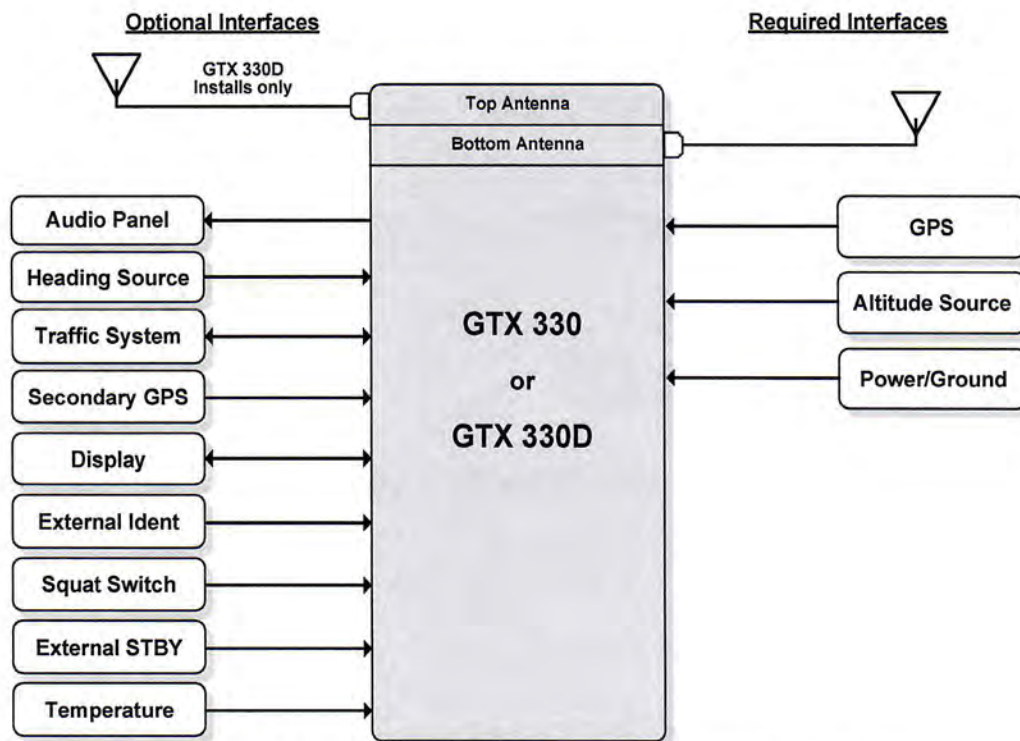
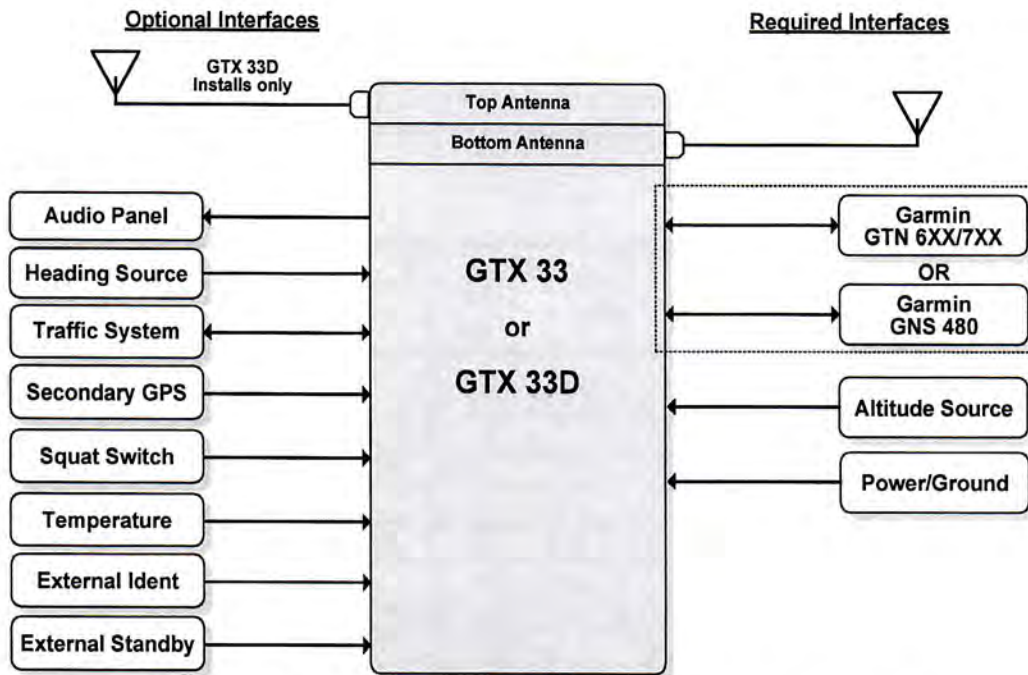

Figure 1 – GTX 330 or GTX 330D Interface Summary



**Figure 2 – GTX 33 or GTX 33D Interface Summary**

The GTX 33X performs the following functions:

- Transmission of ADS-B out data on 1090 extended squitter (1090 MHz)
  - Integration of data from internal and external sources to transmit the following data per 14 CFR 91.227:
    - GPS Position, Altitude, and Position Integrity
    - Ground Track and/or Heading, Ground Speed, and Velocity Integrity
    - Air Ground Status
    - Flight ID, Call Sign, ICAO Registration Number
    - Capability and Status Information
    - Transponder Squawk Codes between 0000-7777.
    - Emergency Status
    - IDENT - initiates SPI (special position identification) pulse for 18 seconds
  - Pressure Altitude Broadcast Inhibit
- Reception of TIS-A traffic data from a ground station
- Provides TIS-A traffic alerting to the pilot via interfaced display and audio output

## 1.2 GTX 3X5

The Garmin GTX 3X5 family consists of the GTX 335, 335R, 345, and 345R transponders. The functional differences between each of these transponders are described in Table 1.

Function	GTX 335	GTX 335 w/GPS	GTX 335R	GTX 335R w/GPS	GTX 345	GTX 345 w/GPS	GTX 345R	GTX 345R w/GPS
Panel mount	x	x			x	x		
Remote mount			x	x			x	x
Mode S	x	x	x	x	x	x	x	x
ADS-B (out)	x	x	x	x	x	x	x	x
ADS-B Traffic					x	x	x	x
FIS-B					x	x	x	x
Internal GPS		x		x		x		x
Bluetooth					x	x	x	x
Optional Garmin Altitude Encoder	x	x	x	x	x	x	x	x

**Table 1 – GTX 3X5 Unit Configurations**

Interfaces to the GTX 3X5 are shown in Figure 3.

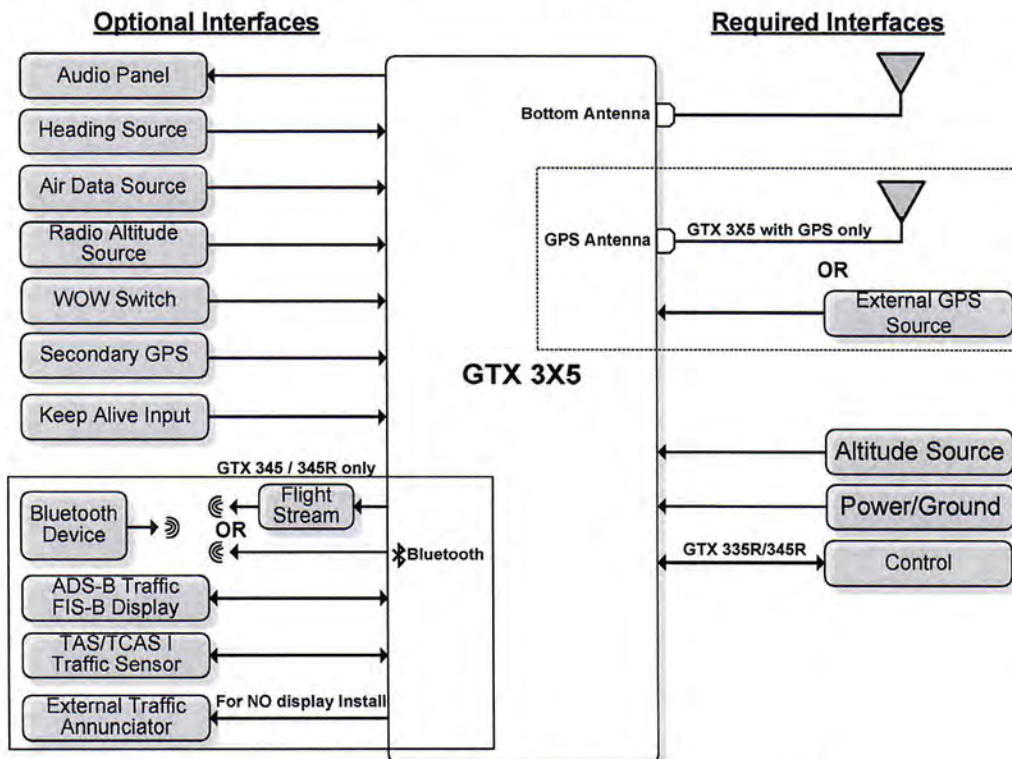

**Figure 3 – GTX 3X5 Interface Summary**



The GTX 3X5 performs the following functions:

- Transmission of ADS-B out data on 1090 extended squitter (1090 MHz)
  - Integration of data from internal and external sources to transmit the following data per 14 CFR 91.227:
    - GPS Position, Altitude, and Position Integrity
    - Ground Track and/or Heading, Ground Speed, and Velocity Integrity
    - Air Ground Status
    - Flight ID, Call Sign, ICAO Registration Number
    - Capability and Status Information
    - Transponder Squawk Codes between 0000-7777.
    - Emergency Status
    - IDENT - initiates SPI (special position identification) pulse for 18 seconds
  - Pressure Altitude Broadcast Inhibit

The GTX 335 performs the following additional functions:

- Reception of TIS-A traffic data from a ground station
- Provide TIS-A traffic alerting to the pilot via interfaced display and audio output.

The GTX 345 performs the following additional functions:

- Reception of ADS-B In data on 1090 MHz
  - ADS-B (Data directly from another transmitting aircraft)
  - ADS-R (Rebroadcast of ADS-B data from a ground station)
- Reception of ADS-B In data on UAT (978 MHz)
  - ADS-B (Data directly from another transmitting aircraft)
  - ADS-R (Rebroadcast of ADS-B data from a ground station)
  - TIS-B (Broadcast of secondary surveillance radar) (SSR) derived traffic information from a ground station.
  - FIS-B (Broadcast of aviation data from a ground station)
- Provide ADS-B traffic information and alerting to the pilot via an interfaced display

- Correlation and consolidation of traffic data from multiple traffic sources
- Aural and visual traffic alerting
- Provide FIS-B data to the pilot via an interfaced display
  - Graphical and textual weather products
    - NEXRAD
    - PIREPs
    - AIRMET/SIGMETs
    - METARs
    - TAFs
    - Winds Aloft
  - Aviation Data
    - TFRs
    - NOTAMs

### **1.3 Capabilities**

The Garmin GTX 33X and GTX 3X5 as installed in this aircraft have been shown to meet the equipment requirements of 14 CFR § 91.227 when operating in accordance with sections 2.1 and 2.2 of this supplement.

### **1.4 Installation Configuration**

This aircraft is equipped with a GTX 33X and/or GTX 3X5 with the following interfaces/ features:

**Equipment Installed:**

Transponder #1

- GTX 330
- GTX 330D
- GTX 33
- GTX 33D
- GTX 335
- GTX 335R
- GTX 345
- GTX 345R

Transponder #2 (if installed)

- GTX 330
- GTX 330D
- GTX 33
- GTX 33D
- GTX 335
- GTX 335R
- GTX 345
- GTX 345R

**Interfaced GPS/SBAS Position Source(s):**

GPS #1

- Internal
- GTN 6XX/7XX Series
- GNS 400W/500W Series
- GNS 480
- GIA 63W
- GDL 88 (GTX 330 only)

GPS #2 (if installed)

- Internal
- GTN 6XX/7XX Series
- GNS 400W/500W Series
- GNS 480
- GIA 63W
- GDL 88 (GTX 330 only)

**Interfaced Pressure Altitude Source:**

Pressure Altitude Source #1

- \_\_\_\_\_
- Garmin Altitude Encoder

Pressure Altitude Source #2 (if installed)

- \_\_\_\_\_
- Garmin Altitude Encoder

**Interfaced Remote Control Display (Required for remotely mounted GTX variants):**

Transponder #1 Remote Control Display

- GTN 6XX/7XX
- GNS 480
- G950/1000 Display
- Gables 7534 Controller

Transponder #2 Remote Control Display (if installed)

- GTN 6XX/7XX
- GNS 480
- G950/1000 Display
- Gables 7534 Controller

**Interfaced Active Traffic System:**

- None
- TCAD
- TAS/TCAS

**NOTE**

If the system includes all of the following components:

- GTX 345R,
- G950/1000 Display, and
- TCAD or TAS/TCAS

Then the aircraft is no longer equipped with a TSO compliant active TCAD, TAS or TCAS system. Any operational requirement to be equipped with such system is no longer met.

## 1.5 Definitions

The following terminology is used within this document:

**ADS-B:** Automatic Dependent Surveillance-Broadcast

**AFM:** Airplane Flight Manual

**AFMS:** Airplane Flight Manual Supplement

**ATCRBS:** Air Traffic Control Radar Beacon System

**CFR:** Code of Federal Regulations

**ES:** Extended Squitter

**GNSS:** Global Navigation Satellite System

**GNS:** Garmin Navigation System

**GPS:** Global Positioning System

**GTX:** Garmin Transponder

**GTN:** Garmin Touchscreen Navigator

**ICAO:** International Civil Aviation Organization

**LRU:** Line Replaceable Unit

**PABI:** Pressure Altitude Broadcast Inhibit

**POH:** Pilot Operating Handbook

**SBAS:** Satellite-Based Augmentation System

**SW:** Software

**TCAS:** Traffic Collision Avoidance System

**TIS:** Traffic Information Service

**TX:** Transmit

## Section 2. LIMITATIONS

### 2.1 Minimum Equipment

The GTX 33X and GTX 3X5 must have the following system interfaces fully functional in order to be compliant with the requirements for 14 CFR 91.227 ADS-B Out operations:

<b>Interfaced Equipment</b>	<b>Number Installed</b>	<b>Number Required</b>
Uncorrected Pressure Altitude Source	1	1
GPS SBAS Position Source	1 or more	1
Remote Control Display (for remotely mounted transponders)	1 or more	1

**Table 2 – Required Equipment**

### 2.2 ADS-B Out

The GTX 33X and GTX 3X5 only comply with 14 CFR 91.227 for ADS-B Out when all required functions are operational. When the system is not operational, ADS-B Out transmit failure messages will be present on the remote control display interface, or the GTX 330 or GTX 3X5 panel display. If a Gables 7534 controller is being used the ADS-B equipment failure condition will be annunciated on the Gables display “Transponder Fail” while the ADS-B Out Position failure will be annunciated by the remotely installed “ADS-B POSN FAIL” Annunciator.

### 2.3 TIS Traffic Display with User Navigation Angle

Display of TIS traffic from a GTX 33/330 or GTX 335 is not permitted with an interfacing display configured for a navigation angle of “user”.

## 2.4 Applicable System Software

This AFMS/AFM is applicable to the software versions shown in Table 3.

The Main GTX software version is displayed on the splash screen during start up for the GTX 330 and GTX 3X5 panel mounted units, and the External LRU or System page on the interfaced remote control display for remotely mounted GTX transponders.

<b>Software Item</b>	<b>Software Version</b> <i>(or later FAA Approved versions for this STC)</i>
GTX 33X Main SW Version	8.04
GTX 3X5 Main SW Version	2.12

**Table 3 - Software Versions**

## 2.5 Pressure Altitude Broadcast Inhibit (PABI)

Pressure Altitude Broadcast Inhibit shall only be enabled when requested by Air Traffic Control while operating within airspace requiring an ADS-B Out compliant transmitter. PABI is enabled by selecting the GTX to ON mode.

## 2.6 Datalinked Weather Display (GTX 345 Only)

Do not use datalink weather information for maneuvering in, near, or around areas of hazardous weather. Information provided by datalink weather products may not accurately depict current weather conditions.

Do not use the indicated datalink weather product age to determine the age of the weather information shown by the datalink weather product. Due to time delays inherent in gathering and processing weather data for datalink transmission, the weather information shown by the datalink weather product may be significantly older than the indicated weather product age.

Do not rely solely upon datalink services to provide Temporary Flight Restriction (TFR) or Notice to Airmen (NOTAM) information.

## 2.7 Portable Electronic Devices

This STC does not relieve the operator from complying with the requirements of 91.21 or any other operational regulation regarding portable electronic devices.

**Section 3. EMERGENCY PROCEDURES**

**3.1 Emergency Procedures**

No Change.

**3.2 Abnormal Procedures**

**3.2.1 LOSS OF AIRCRAFT ELECTRICAL POWER GENERATION**

XPDR Circuit Breaker ..... **PULL**

Transponder and ADS-B Out functions will no longer be available.

**NOTE**

This guidance is supplementary to any guidance provided in the POH or AFM for the installed aircraft for loss of power generation.

**3.2.2 LOSS OF GPS/SBAS POSITION DATA**

When the GPS/SBAS receiver is inoperative or GPS position information is not available or invalid, the GTX will no longer be transmitting ADS-B Out data.

For GTX 330 installations:

**NO ADSB annunciator illuminated:**

Interfaced GPS position sources ..... **VERIFY VALID POSITION**

For GTX 3X5 installations:

**NO 1090ES TX annunciator illuminated:**

Interfaced GPS position sources ..... **VERIFY VALID POSITION**

For GTX 33 and GTX 3X5R installations:

**Reference Display Device documentation for applicable annunciation:**

Interfaced GPS position sources ..... **VERIFY VALID POSITION**



## Section 4. NORMAL PROCEDURES

The procedures described below are specific only to the panel mounted GTX 330 or GTX 3X5 transponders. Cockpit Reference Guides and Pilot Guides for interfaced remote control displays will provide additional operating information specific to the displays or other traffic systems.

ADS-B Out functionality resides within the GTX transponders thereby providing a single point of entry for Mode 3/A code, Flight ID, IDENT functionality and activating or deactivating emergency status for both transponder and ADS-B Out functions. Details on performing these procedures are located in the GTX 330/330D Pilot's Guide and GTX 3X5 Series Transponder Pilot's Guide.

### 4.1 Unit Power On

For GTX 330 installations:

GTX Mode ..... **VERIFY ALT**  
NO ADSB ..... **CONSIDERED**

For GTX 3X5 installations:

GTX Mode ..... **VERIFY ALT**  
NO 1090ES TX ..... **CONSIDERED**

#### **NOTE**

The NO ADS-B or NO 1090ES TX Annunciation (or associated display annunciations) may illuminate as the unit powers on and begins to receive input from external systems, to include the SBAS position source.

**4.2 Before Takeoff**

For GTX 330 installations:

ADS-B TX..... **VERIFY ON**  
NO ADSB..... **EXTINGUISHED**

For GTX 3X5 installations:

1090ES TX CTL..... **VERIFY ON**  
NO 1090ES TX ..... **EXTINGUISHED**

**NOTE**

The ADS-B TX or 1090ES TX CTL must be turned on and the NO ADS-B or NO 1090ES TX Annunciation (or associated display annunciations) must be **EXTINGUISHED** for the system to meet the requirements specified in 14 CFR 91.227. This system must be operational in certain airspaces after January 1, 2020 as specified by 14 CFR 91.225.

**Section 5. PERFORMANCE**

No change.

**Section 6. WEIGHT AND BALANCE**

See current weight and balance data.

## Section 7. SYSTEM DESCRIPTION

The Garmin GTX 330 and GTX 3X5 Pilot's Guides, part numbers, and revisions listed below contain additional information regarding GTX system description, control, and function.

<u>Title</u>	<u>Part Number</u>	<u>Revision</u>
GTX 330 Pilot's Guide	190-00207-00	Rev. G (or later)
GTX 3X5 Pilot's Guide	190-01499-00	Rev. A (or later)

Pilot's Guides for interfaced displays, part numbers and revisions listed below, provide additional operating information for the Garmin GTX 33 and GTX 3X5R.

<u>Title</u>	<u>Part Number</u>	<u>Revision</u>
Garmin GTN 725/750 Pilot's Guide	190-01007-03	Rev. E (or later)
Garmin GTN 625/635/650 Pilot's Guide	190-01004-03	Rev. E (or later)
GNS 480 Pilot's Guide	190-00502-00	Rev. D (or later)
GTX 3X5 Series Transponder G1000 Pilot's Guide	190-01499-01	Rev. A (or later)

### 7.1 GTX TIS Behavior

The TIS Standby/Operate controls for GTX 33/330 and GTX 335 units only function when the aircraft is airborne.

### 7.2 GTX 345R and G950/1000 No Bearing Traffic Alerts

No visual indication is provided for no bearing traffic alerts. Only an aural indication of the no bearing traffic alert is provided. If an aural alert for no bearing traffic has been previously issued, a "no bearing traffic clear" aural indication will be provided once all traffic alerts are resolved.

All aural alerts are inhibited below 500' AGL, therefore a "no bearing traffic clear" aural may not be heard in a landing or touch and go flight scenario.

Shadin Co. Inc.  
6950 Wayzata Blvd.  
Minneapolis, MN 55426

SUPPLMNT.MNL

FAA APPROVED  
AIRPLANE FLIGHT MANUAL SUPPLEMENT  
FOR

Model: Piper Seneca  
PA-34-200T  
PA-34-220T

REG. NO. N75727  
SER. NO. 34-5070084

This supplement must be attached to the FAA Approved Airplane Flight Manual when the Digital Fuel Flow Meter is installed in accordance with STC SA641GL. The information contained herein supplements the information of the Basic Airplane Flight Manual; for limitations, procedure, and performance information not contained in this supplement, consult the basic Airplane Flight Manual.

FAA APPROVED:

FOR

Gary S. Lousier  
W. F. Horn, Chief,  
Chicago Aircraft  
Certification Office  
FAA Central Region

DATE: June 5, 1986

REVISED: \_\_\_\_\_

Shadin Co. Inc.  
6950 Wayzata Blvd.  
Minneapolis, MN 55426

I. LIMITATIONS:  
=====

	Indicator P/N	Manual P/N	Rev.
Shadin operating manual	910502	050500	-
	910504	050500	-
	910514	050510	-
	910522	050520	-
	910524	050520	-
	910532	050530	-
	910534	050530	-

must be carried onboard the aircraft at all times.

For operating procedure refer to the operator's manual appropriate to the system installed in the aircraft.

If the analog fuel flow indicator is removed then the fuel flow red line limitation on the basic Flight manual does not apply.

II. PROCEDURES:  
=====

Refer to the appropriate Shadin provided operating manual.

III. PERFORMANCE:  
=====

No change.

FAA APPROVED June 5, 1986

REVISED DATE \_\_\_\_\_

Horizon Instruments, Inc.  
600 South Jefferson Street, Unit C  
Piacentia, CA 92870

Supplement Number: 1

FAA - Approved  
Airplane Flight Manual Supplement  
For  
**Piper PA-34-200T**

with (2) Continental TSIO-360 engines

Reference: Type Certificate Data Sheet: A7SO

Airplane Registration Number: N35727 Airplane Serial Number: 34-8070084

This supplement must be attached to the Airplane Flight Manual when this airplane is modified by the installation of two Horizon Instruments, Inc.'s Model P-1000 Electronic Digital Tachometer, both with Part Number P100-970-609-00, Serial Numbers 1808401 and 1808402, in accordance with FAA Approved Model List STC SA01923LA.

The information contained in this document supplements or supersedes the basic manual only in those areas listed. For limitations, procedures and performance information not contained in this supplement, consult the basic airplane flight manual.

FAA APPROVED:

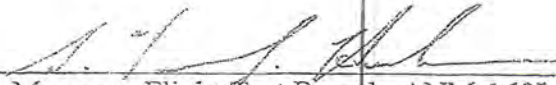
  
Manager, Flight Test Branch, ANM-160L  
Federal Aviation Administration  
Los Angeles Aircraft Certification Office  
Transport Airplane Directorate

Original Approval Date: 1/04/2007

Revision Date: August 3, 2007

Horizon Instruments, Inc.  
600 South Jefferson Street, Unit C  
Placentia, CA 92870  
Supplement Number: 1

AFM Supplement to  
Piper PA-34-200T

FAA AML STC SA01923LA

Revision Number	Pages	Description	FAA-Approved
Original	1 thru 7	Original Issue	<u>Hien Tong</u> -acting Manager, Flight Test Branch, ANM-160L FAA, Los Angeles ACO Transport Airplane Directorate  Date: <u>1/04/07</u>
A	1 of 7 3 of 7	Tachometer Part Number Change	 Manager, Flight Test Branch, ANM-160L FAA, Los Angeles ACO Transport Airplane Directorate  Date: <u>8-3-07</u>

Section I. General: No Change

Section II. Limitations

This table lists each engine operating range by the lowest RPM within the operating range. Ranges are listed in order from the highest (engine Red-line) on the left side of the table to the lowest on the right side. Note that an RPM range with no colored marking is denoted as a black, or "BLK", range.

Tachometer Part Number	RPM ARC PLACARDING										CYL
	TOP ARC		ARC 2		ARC 3		ARC 4		LOW ARC		
	RPM	COLOR	RPM	COLOR	RPM	COLOR	RPM	COLOR	RPM	COLOR	
P100-970-609-00	2575	RED	2574 2200	GRN	2199 2000	YEL	1999 500	GRN	---	---	6

Placards:

The face of the P-1000 tachometer is placarded with the Engine RPM Operating Range information that normally appears on the face of the mechanical tachometer. This includes the red restricted, yellow cautionary or transient and green normal operation RPM ranges.

A placard is provided to label the newly installed circuit breaker for operation with the P-1000 tachometer. This placard is placed on the circuit breaker panel. See Figure 1.

Figure 1, Circuit Breaker Placard

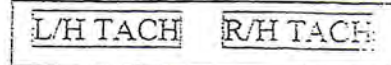

Section III. Emergency Procedures: No Change

Section IV. Normal Procedures

The operation of the P-1000 Electronic Digital Engine Tachometer is straightforward. After power is supplied to the Tachometer, the engine is started and the self-tests are performed, the default display of engine RPM appears on the display. The default display is insured via the use of internal timers that will restore the display to the current RPM even in the event that one of the panel buttons becomes stuck or defective.

Internally, two independent tachometers watch the pulses received from each magneto. Each tachometer is accurate to less than 1 RPM and can be individually enabled/disabled via buttons on the face of the Tachometer.

Engine operating ranges are indicated on the large green, yellow, and red LEDs. (See page 7, items D, E, and F.)



Three small LED magneto systems *alert* indicator lights are located within the "Status" area on the upper left corner of the Tachometer face. (See items A, B, and C on page 7, Figure 2.) The left and right red LED *alert* indicator lights, when illuminated, indicate, because of a loss of the ignition signal to the Tachometer, a possible malfunction of the respective left or right magneto ignition system.

While performing a magneto check during engine run-up, the red *alert* indicator lights will illuminate, thus identifying the grounding of the respective right or left magneto systems.

IGNITION SWITCH POSITION	TACHOMETER MAGNETO ALERT INDICATOR LIGHT	
	RIGHT	LEFT
OFF	On	On
R	Off	On
L	On	Off
BOTH	Off	Off

Between the left and right red magneto ignition systems *alert* indicators is a yellow "RPM Synchronization" indicator. This small yellow indicator is illuminated when there is a difference of more than 80 RPM between the right and left tachometers. This indicator also may flicker during extreme RPM excursions of the engine.

There are three panel buttons. (See items I, J, and K on page 7, Figure 2.) Each button has two modes of operation:

- ◆ Press-and-hold,
- ◆ Press-and-release.

Press-and-hold button operations instruct the Tachometer to perform a *Specific operation* when a button is pressed and held for more than 2/3 of a second. Press-and-hold button operations are placarded on the face of the Tachometer above each button. Similarly, press-and-release button operation instructs the Tachometer to perform a specific operation when a button is pressed and released in less than 2/3 of a second. Press-and-release button operations are placarded on the face of the Tachometer below each button.

#### PRESS AND HOLD OPERATIONS:

The left button (**Hours**) pressed and held, will cause the Tachometer to display the non-fractional portion (0000.) of the current accumulated engine hours. When the button is released, the fractional part of the engine hours (.00) is displayed for a short period of time. The clock is started whenever the engine RPM exceeds 800 RPM and is recorded in real hours.

The right button (**Trap**) pressed and held, will cause the Tachometer to display the current contents of the RPM trap. This trap records the highest engine RPM achieved before the button was pressed. The middle button (**Clear**) pressed and held, clears the RPM trap. During depression of this button, the RPM trap is zeroed. When the button is released, the trap will record the current engine RPM.

**PRESS AND RELEASE OPERATIONS:**

During normal operation, the Tachometer presents the average of the left and right internal tachometers on the display. However, a mechanism exists to mask either tachometer from the display, leaving the remaining tachometer to display its RPM.

The regular flashing of the right or left signal loss status indicator LEDs indicates a masked tachometer. This feature is handy when attempting to determine magneto/ignition problems.

Quickly pressing and releasing the left button (**L**) causes the Tachometer to mask or un-mask the left internal tachometer.

Quickly pressing and releasing the right button (**R**) causes the Tachometer to mask or un-mask the right internal tachometer.

An internal interlock prevents masking both internal tachometers at the same time, therefore preventing total loss of RPM indication.

If the tachometer is masked, pressing the button will un-mask it and allow its RPM to show on the display, and conversely, if the tachometer is un-masked, pressing the button will mask it from the display.

Quickly pressing and releasing the center button (**Dim**) causes the Tachometer to alternately dim or brighten the LED indicators.

The LED indicators, (See, items A through F.) are bright enough to overcome daylight washout conditions. However, during night operations the large green, yellow, and small red and yellow LEDs are dim-able. The large red LED still operates at full intensity to maximize the possibility of gaining pilot attention during excursion into restricted RPM ranges.

Section V     **Performance:** No Change

Section VI    **Weight & Balance and Equipment List:** Negligible change

## Section VII System Description

The Horizon Instruments, Inc. Model P-1000 Electronic Digital Engine Tachometer is an electronic replacement for the existing mechanical cable-driven tachometer.

The Tachometer differs from the existing mechanical tachometer in the following areas:

The Tachometer is fully electronic and uses timing information from the primary leads ("P-Leads") of both the left-hand and right-hand magneto ignition systems, operating the P-1000's internal left and right tachometers, to determine engine rpm; instead of a rotating cable driving a magnetic slip-clutch analog type display.

The Tachometer uses super bright LED indicators to indicate normal range engine operation (Green LED), cautionary range operation (Yellow LED), and do-not-exceed or restricted range RPM (Red LED) as substitutes for the ranges normally painted on the tachometer dial.

The primary display consists of four 1/2" high characters on a backlit Liquid Crystal Display (LCD), easily and clearly visible in daylight and night flying.

Diagnostic features available include: *alert* indication of loss of magneto signal, *alert* indication that both magnetos are reporting different rpm, and the ability to mask RPM indications from either magneto.

Magneto test, via the ignition switch, is indicated by the illumination of the grounded magneto system's *alert* light and the display of the amount of RPM that the engine has slowed. This is indicated as a negative number on the display (number is preceded by a leading hyphen or minus sign).

LED indicators are dim-able (except the restricted or red-light indicator) to reduce pilot annoyance during night flying.

A specific engine hour is preset at the factory to accommodate Tachometer changes on non-zero-time engines. Only Horizon Instruments, Inc may change engine time.

- A. Right Magneto System *Alert* Indicator
- B. RPM Sync Loss *Alert* Indicator
- C. Left Magneto System *Alert* Indicator
- D. Normal Operating Green RPM Range Indicator
- E. Cautionary Yellow RPM Range Indicator
- F. Restricted Red RPM Range Indicator
- G. Example of Placard Area, consult STC and Section for limitations specific to your aircraft
- H. 4 Digit LCD Display
- I. Right Button for Over speed Trap display and right tachometer enable/disable
- J. Middle Button for Over speed Trap Clear and LED indicator dimming
- K. Left Button for Engine Hours display and left tachometer enable/disable

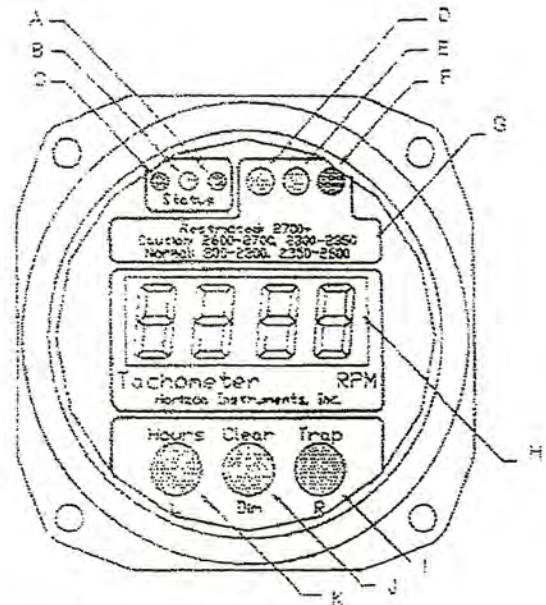

Figure 2, Basic Tachometer Features

### Section VIII Additional Information

For additional information about the operation and installation, refer to Horizon Instruments, Inc. Document Number P103050, "P-1000 Installation & Instruction Manual."

The exterior of the P-1000 is name plated with all pertinent operational and configuration information, see Figure 3.

Horizon Instruments, Inc  
600 South Jefferson Street, Unit C  
Placentia, CA 92870, USA  
Model P-1000 Digital Tachometer  
H/W P/N: P100100-  
S/W P/N: P132001, Vers. 1.06  
8-30 VDC, 200ma max, 1/2 lb  
Serial Number: 00000  
Red Arc: 2700 RPM  
Green Arc: 2699-1800 RPM  
Cylinders: 6  
FAA PMA  
Application  
XXXX Series  
Patent Number: 4.811.255

Figure 3. Example of Product Identification Nameplate

# AIRPLANE FLIGHT MANUAL SUPPLEMENT

For

**Aircraft Lighting & Components, LTD**

**Wingtip Landing Lights**

THIS DOCUMENT TO BE KEPT WITH THE A.F.M. (or equivalent) AT ALL TIMES

Day or Night Operation: Turn Control Switch ON.

**Caution:** Lights may cause spatial disorientation if operated while in clouds

PRODUCTION DATA:

**Model PA100**

**Serial no.**  
\_\_\_\_\_

Lamp Replacement: Replace with GE 4509, 4595, H7604 lamp

AIRCRAFT LIGHTING & COMPONENTS, LTD  
156 BUNKER CREEK ROAD, CHEHALIS, WA 98532 360-748-4089

AIRCRAFT LIGHTING & COMPONENTS, LTD.  
*Wingtip Landing Lights Installation Instructions*

---

**Callouts for Wire Routing Diagrams:**

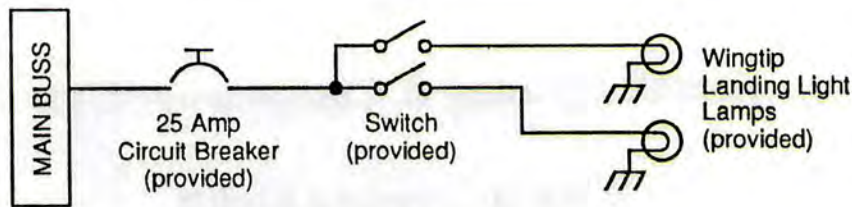

WIRING SCHEMATIC

- A Secure wire to end rib with Adel clamp, etc.
- B If the airplane is equipped with a slaved compass system, route the wire as far away from the flux detector as possible.

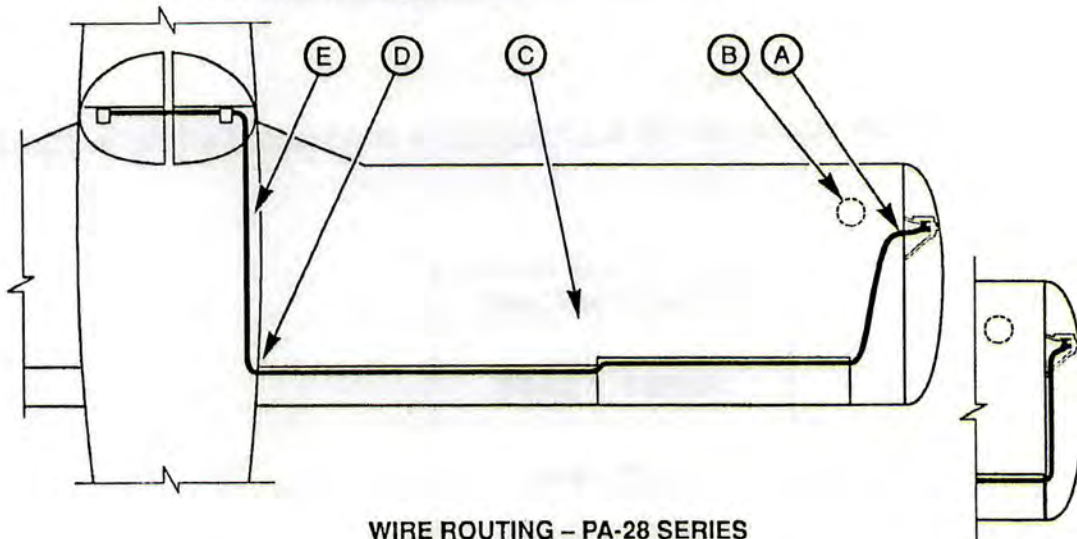

WIRE ROUTING - PA-28 SERIES

- C **Wire routing - PA-28 airplanes:** Run the wire to the outer end of the rear wing spar, being careful to route the wire so that it does not interfere with the movement of the aileron balance arm. Drill through the web of the end rib of the rear spar and insert a 1/8" grommet. Pass the wire through the grommet.

Run the wire along the under-surface of the wing upper skin as close to the rear spar as possible. Drill a series of #28 (9/64") holes on approximately 12" centers, starting immediately inboard of the aileron outer hinge. Position the holes in line with and between the wing skin attach rivets. Attach the wire hangers using the 6-32 screws and nuts provided. (in the area of the rear spar ahead of the wing flaps the wire will

AIRCRAFT LIGHTING & COMPONENTS, LTD.  
*Wingtip Landing Lights Installation Instructions*

---

continue to be attached to the upper wing skin as before, but will be separated from the flap by the diagonal stiffener.

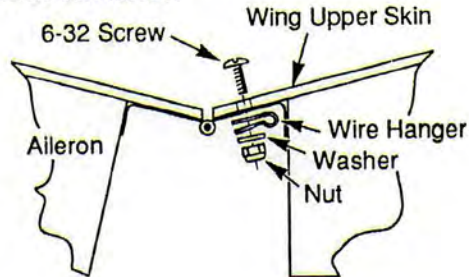

At the inboard end of the wing the wire should be routed so as to avoid interfering with the flap actuating rod.

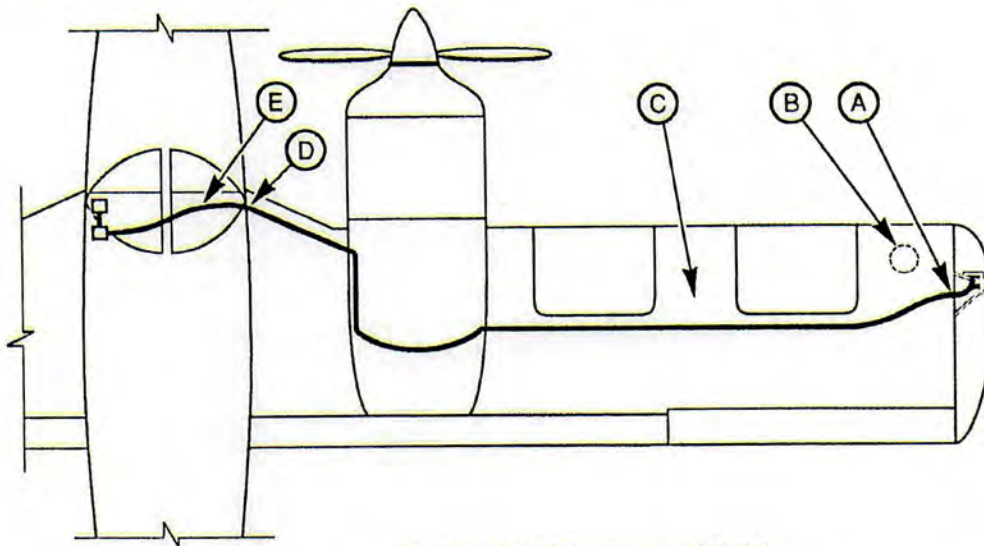

WIRE ROUTING - PA-34 SERIES

- D **Wire routing - PA-34 airplanes:** Run with the existing wire bundle, securing it to the bundle using the wire bundle ties provided.
- E Bring the wire into the fuselage at a point where the wire will not interfere with the control cables, fluid lines, or other wires. Install a rubber grommet where the wire passes through the fuselage skin.
- F Run the wire under the floor and secure it so that it does not interfere with the control cables, fluid lines or other wires.

**TABLE OF CONTENTS**

**SECTION 10**

**SAFETY TIPS**

Paragraph No.		Page No.
10.1	General . . . . .	10-1
10.3	Safety Tips . . . . .	10-1



SECTION 10  
SAFETY TIPS

10.1 GENERAL

This section provides safety tips of particular value in the operation of the Seneca II.

10.3 SAFETY TIPS

- (a) Learn to trim for takeoff so that only a very light back pressure on the wheel is required to lift the airplane off the ground.
- (b) On takeoff, do not retract the gear prematurely. The airplane may settle and make contact with the ground because of lack of flying speed, atmospheric conditions, or rolling terrain.
- (c) Flaps may be lowered at airspeeds up to 107 KIAS. To reduce flap operating loads, it is desirable to have the airplane at a slower speed before extending the flaps. The flap step will not support weight if the flaps are in any extended position. The flaps must be placed in the "UP" position before they will lock and support weight on the step.
- (d) Before attempting to reset any circuit breaker, allow a two to five minute cooling off period.
- (e) Always determine position of landing gear by checking the gear position lights.
- (f) A high fuel pressure indication on the fuel flow indicator is a possible sign of restricted fuel nozzles.
- (g) The shape of the wing fuel tanks is such that in certain maneuvers the fuel may move away from the tank outlet. If the outlet is uncovered, the fuel flow will be interrupted and a temporary loss of power may result. Pilots can prevent inadvertent uncovering of the outlet by avoiding maneuvers which could result in uncovering the outlet.

Extreme running turning takeoffs should be avoided as fuel flow interruption may occur.

Prolonged slips and skids which result in excess of 2000 feet of altitude loss, or other radical or extreme maneuvers which could cause uncovering of the fuel outlet must be avoided as fuel flow interruption may occur when the tank being used is not full.

- (h) The rudder pedals are suspended from a torque tube which extends across the fuselage. The pilot should become familiar with the proper positioning of his feet on the rudder pedals so as to avoid interference with the torque tube when moving the rudder pedals or operating the toe brakes.
- (i) Anti-collision lights should not be operating when flying through overcast and clouds, since reflected light can produce spacial disorientation. Do not operate strobe lights when taxiing in the vicinity of other aircraft.
- (j) In an effort to avoid accidents, pilots should obtain and study the safety related information made available in FAA publications such as regulations, advisory circulars, Aviation News, AIM and safety aids.
- (k) Pilots who fly above 10,000 feet should be aware of the need for special physiological training. Appropriate training is available at approximately twenty-three Air Force Bases throughout the United States for a small fee. The training is free at the NASA Center in Houston and at the FAA Aeronautical Center in Oklahoma.

Forms to be completed (Physiological Training Application and Agreement) for application for the training course may be obtained by writing to the following address:

Chief of Physiological Training, AAC-143  
FAA Aeronautical Center  
P. O. Box 25082  
Oklahoma City, Oklahoma 73125

It is recommended that all pilots who plan to fly above 10,000 feet take this training before flying this high and then take refresher training every two or three years.

- (l) Sluggish RPM control and propeller overspeed with poor RPM recovery after rapid throttle application are indications that nitrogen pressure in the propeller dome is low.
- (m) Experience has shown that the training advantage gained by pulling a mixture control or turning off the fuel to simulate engine failure at low altitude is not worth the risk assumed, therefore, it is recommended that instead of using either of these procedures to simulate loss of power at low altitude, the throttle be retarded slowly to idle position. Fast reduction of power may be harmful to the engine.